

Hi5-4K-Plus Mini-Converter

SDI to HDMI



Installation and Operation Guide

Version 1.12r1
Published July 25, 2022



Notices

Trademarks

AJA® and Because it matters.® are registered trademarks of AJA Video Systems, Inc. for use with most AJA products. AJA™ is a trademark of AJA Video Systems, Inc. for use with recorder, router, software and camera products. Because it matters.™ is a trademark of AJA Video Systems, Inc. for use with camera products.

Corvid Ultra®, Io®, Ki Pro®, KONA®, KUMO®, ROI® and T-Tap® are registered trademarks of AJA Video Systems, Inc.

AJA Control Room™, KiStor™, Science of the Beautiful™, TruScale™, V2Analog™ and V2Digital™ are trademarks of AJA Video Systems, Inc.

All other trademarks are the property of their respective owners.

Copyright

Copyright © 2022 AJA Video Systems, Inc. All rights reserved. All information in this manual is subject to change without notice. No part of the document may be reproduced or transmitted in any form, or by any means, electronic or mechanical, including photocopying or recording, without the express written permission of AJA Video Systems, Inc.

Contacting AJA Support

When calling for support, have all information at hand prior to calling. To contact AJA for sales or support, use any of the following methods:

| | |
|---------------|-------------------------------------------------------|
| Telephone | +1.530.271.3190 |
| FAX | +1.530.271.3140 |
| Web | https://www.aja.com |
| Support Email | support@aja.com |
| Sales Email | sales@aja.com |

Contents

| | |
|-------------------------------------------------------|----|
| Notices | 2 |
| Trademarks | 2 |
| Copyright | 2 |
| Contacting AJA Support | 2 |
| Chapter 1 – Introduction | 4 |
| Overview | 4 |
| Default Operation | 4 |
| AJA Mini-Config Control | 5 |
| Features | 5 |
| Block Diagram | 6 |
| I/O Connections | 6 |
| Installation | 7 |
| Chapter 2 – Operation | 8 |
| USB Control and Setup—Using AJA Mini-Config | 8 |
| Acquiring AJA Mini-Config | 8 |
| Installing AJA Mini-Config | 8 |
| Running AJA Mini-Config | 10 |
| Operating AJA Mini-Config | 11 |
| Tabbed Screens | 12 |
| Input Tab Screen | 13 |
| Output Tab Screen | 15 |
| HDR Metadata Screen | 16 |
| Custom HDMI Metadata | 17 |
| Output Overrides | 18 |
| Audio Tab Screen | 19 |
| Update Tab Screen | 20 |
| Software Update Procedure | 20 |
| Info Tab Screen | 21 |
| Appendix A – Specifications | 22 |
| Appendix B – Safety and Compliance | 25 |
| Warranty and Liability Information | 32 |
| Index | 33 |

Chapter 1 – Introduction



Overview

AJA's Hi5-4K-Plus preserves your vision with pristine image fidelity and HFR support up to 60p for 4K/UltraHD SDI to HDMI 2.0 conversion needs. The Hi5-4K-Plus can also generate HDR metadata in accordance with HDMI v2.0a/CTA-861.3 and includes HLG support.

Hi5-4K-Plus provides a simple monitoring connection from professional 4K devices using Quad 3G-SDI, Quad 1.5G-SDI, or Dual 3G-SDI outputs to new displays with HDMI 2.0 inputs, for cost-effective monitoring for 4:4:4/4:2:2 60p professional workflows.

Default Operation

The Hi5-4K-Plus auto configures to the connected inputs (no dipswitch settings required).

The auto-configure function identifies the connected inputs, and outputs the default or user configured HDMI output for the given input.

AJA's Mini-Config application is available for firmware updates and advanced configuration.

NOTE: Signal conversion requires the presence of a valid SDI video signal on one of the SDI IN BNC connectors.

For single SD or HD inputs, BNC input 1 is the default input. For dual-link 1.5Gb HD inputs, and 4K dual-stream 3Gb SDI inputs, inputs 1 and 2 are default. Where applicable, both level A and B 3Gb inputs are auto-detected and supported.

When connecting the Hi5-4K-Plus with multiple SDI inputs in the auto-configure mode (default), as the user connects the first HD-SDI to input 1, the unit will output that input as a full screen HD. As soon as the second input is connected, the unit will know that the input is 4K/UHD and the display will change to show the two connected quadrants in the upper left and upper right of the 4K output. The remaining two quadrants will be displayed as they are connected.

It is possible to use two dual stream 3G inputs to make 3840 or 4K video. In this case SDI1 and SDI2 are assumed to be the inputs: SDI1 linkA makes the top left quadrant, SDI1 linkB makes the top right quadrant, SDI2 linkA makes the lower left quadrant, and SDI2 linkB makes the lower right quadrant. To use this mode change the Video Source Selection to '2 X SDI 4K'.

The Hi5-4K-Plus will output either 4Kx2160 or 3840x2160 if more than one HD input is present and the monitor can support those resolutions. For 4K input the Hi5-4K-Plus may provide a center cut 3840, or pass the 4096 to the output, but there is no scaling between the two.

AJA Mini-Config Control

Advanced control will support channel selection and mapping for eight channels of audio from either of two groups of eight channels on any of the four SDI inputs.

Configuration set via AJA Mini-Config is stored in the Hi5-4K-Plus unit through subsequent power cycles.

Features

- Convert Quad-3G-SDI to HDMI 2.0b at up to 4K 60p (see "[Specifications](#)" on [page 22](#) for a complete list of supported inputs)
- Support for 4:4:4/4:2:2/4:2:0 HDMI 2.0b output
- HDR signaling metadata pass-through and optional override
- HDR support for HDR10 and HLG
- Embedded audio pass-through of E-AC-3 (Dolby Digital Plus) compressed audio, including DD+ Atmos
- Configure via USB port and supplied Mini-Config software
- Uses 5-20VDC power (DWP-U-R1 universal power supply included)
- Five year warranty

NOTE: 3D is not supported in this converter.

NOTE: 720p 4:4:4 formats are not supported in this release.

Block Diagram

Figure 1. Hi5-4K-Plus Converter, Simplified Block Diagram

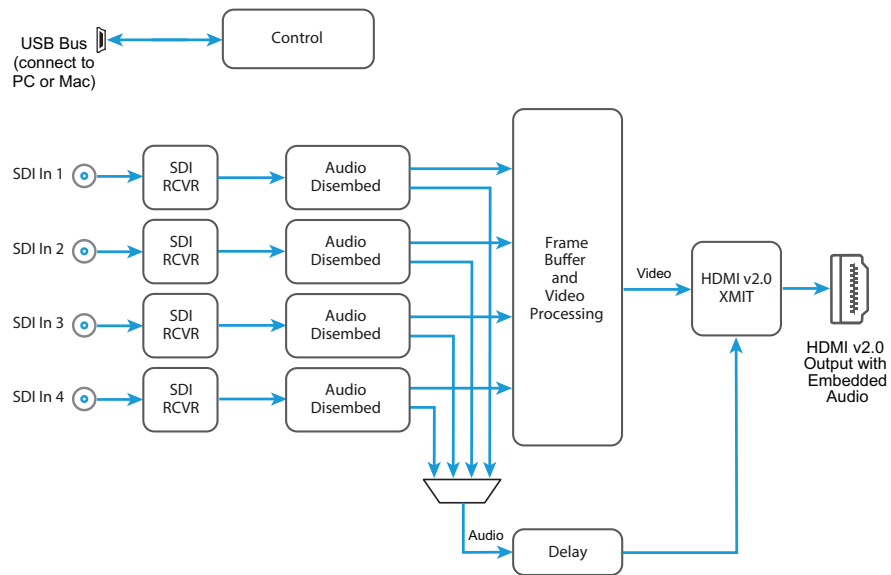

I/O Connections

Figure 2. Hi5-4K-Plus Converter Connections



NOTE: The LEDs adjacent to each SDI connector indicate by color the detected signal type. Off is no signal, Green is SD-SDI, red is HD-SDI, and amber is 3G-SDI.

Installation

Typically, Hi5-4K-Plus installation consists of the following steps:

1. Ensure the Hi5-4K-Plus is disconnected from power.
2. Connect video equipment to the converter BNCs and HDMI connector.
3. Apply power to the converter (AJA power supply included).
4. The Hi5-4K-Plus will now run using the default factory settings. If you wish to alter the factory settings, you'll need to:
 - Install the AJA Mini-Config software on your computer
 - Attach the Hi5-4K-Plus via USB
 - Make your changes using AJA Mini-Config setup screens.

This process is detailed in "[USB Control and Setup—Using AJA Mini-Config](#)" on page 8.

NOTE: *The Hi5-4K-Plus packs an unprecedented feature set into a mini converter box. As a result, the unit uses approximately 12 watts of power. It will be very warm to the touch, which is normal. The unit is engineered to operate across the full temperature range, from 0 to 40 degrees C.*

NOTE: *For highest reliability, the mini converter relies on convection cooling instead of using a built-in fan. Therefore, when installing the unit, mount in a location where it has access to air for proper cooling. Do not stack the Hi5-4K-Plus with other mini converters.*

Chapter 2 – Operation

USB Control and Setup—Using AJA Mini-Config

Your AJA Mini-Converter can be used right out of the box for some applications since it is designed to recognize inputs and perform standard actions automatically by default. However, to use its full capability, you must use AJA's Mini-Config software application for PCs and Macs. This same application can be used to update to new Mini-Converter software released by AJA.

Acquiring AJA Mini-Config

AJA's Mini-Config application is available for download from the AJA website.

To download the latest AJA Mini-Config package, which includes the AJA Mini-Config application, Mini-Converter firmware, and documentation, go to:

<https://www.aja.com/products/mini-config-software>

Select either the Windows or Mac icon to download the desired version.

Mini-Converter Documentation

Included with the AJA Mini-Config package is a complete set of documentation for all Mini-Converters supported by AJA Mini-Config. A .PDF of the *Installation and Operation Guide* for the currently connected Mini-Converter can be accessed from the AJA Mini-Config UI via the **Help/Manual** drop-down menu.

Documentation for all AJA Mini-Converters that use AJA Mini-Config can also be accessed directly in the AJA Mini-Config download package Documentation folder, and via the Documentation icon available on the Mac installer.

Documentation (and firmware) included with the AJA Mini-Config application are the versions available at the time of distribution. However, Mini-Converter software, firmware and documentation are updated regularly, so newer versions may exist.

To download the latest documentation for an individual Mini-Converter, go to:

<https://www.aja.com/family/mini-converters>

and navigate to the Support web page of that Mini-Converter.

Installing AJA Mini-Config

PC Installation

To install AJA Mini-Config on a Windows PC:

1. Download the application from the AJA website (select the Windows icon on the AJA Mini-Config Support web page).
2. Open the AJA_MiniConfig.zip file
3. Double-click on the MiniInstaller.msi file.
4. A Setup Wizard will guide you through the installation.

Figure 3. AJA Mini-Config PC Setup Wizard

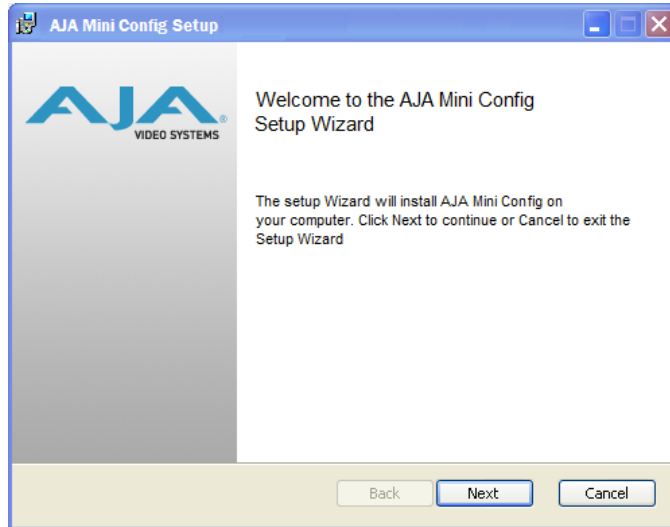

5. Click Next to begin. Answer the questions in the subsequent dialogues. When finished, an AJA Mini-Config shortcut will be installed on the desktop, and you will be able to locate the AJA Mini-Config application in the AJA folder in the Programs listing.

NOTE: If the AJA Mini-Config application already exists on the PC, a different Setup Wizard appears.

Figure 4. AJA Mini-Config Setup Wizard, Reinstallation

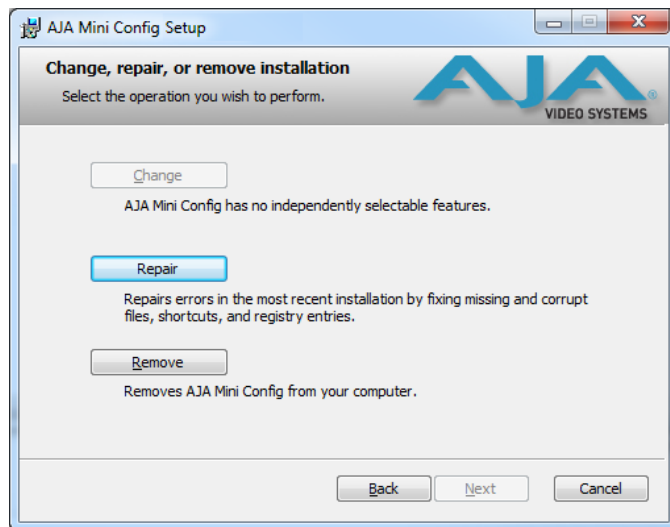

With this screen you can **Repair** (reinstall) or **Remove** (uninstall) AJA Mini-Config on the PC.

Mac Installation

To install the application on a Mac:

NOTE: Macintosh computers must be Intel-based (G5, G4 and earlier models will not work with AJA Mini-Config).

1. Download the application from the AJA website (select the Apple icon on the AJA Mini-Config Support web page).
2. Open the AJA_MiniConfig folder.
3. Double-click on the AJAMiniConfig.dmg file.

4. Answer the prompt and a utility program will be launched.

Figure 5. AJA Mini-Config Mac Installer

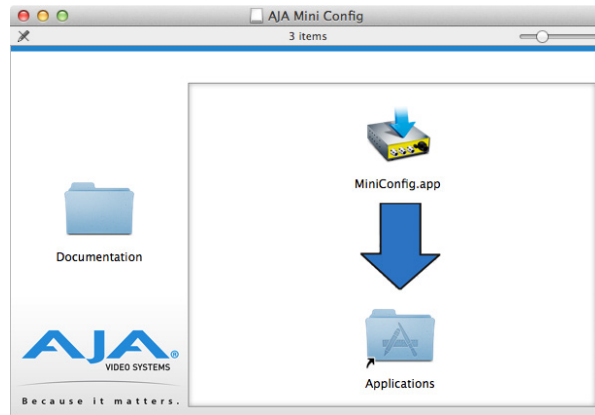

5. To complete the installation drag the “MiniConfig.app” icon to the Applications folder.

Running AJA Mini-Config

Connect the Mini-Converter to the PC or Mac via the supplied USB cable. Connect the external power supply (supplied) to the Mini-Converter.

PC Startup

To run AJA Mini-Config on a PC, double-click on the AJA Mini-Config icon on your desktop, or open the AJA folder in the program list and click on the AJA Mini-Config application located inside the AJA Mini-Config folder.

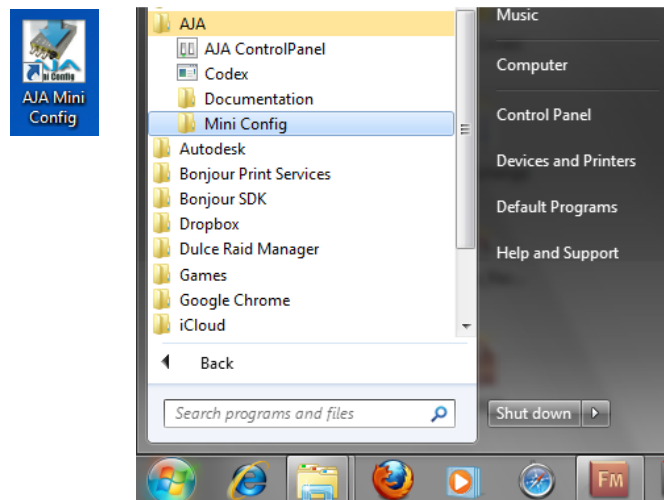

Mac Startup

To run AJA Mini-Config on a Mac, open the Applications folder and locate the AJA Mini-Config application. Double-click the application to launch it.

Saving Setups

A **File** drop down menu on the AJA Mini-Config application bar allows you to save the current state of the Mini-Converter to a preset file for later recall.

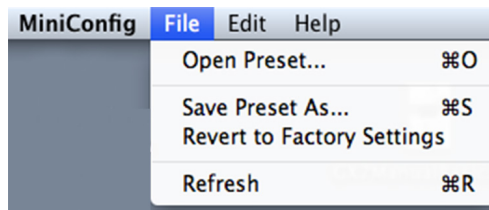

Using this feature you can set up the converter for different applications, storing each configuration (**Save Preset As...**) with a unique name for easy recall (**Open Preset...**).

A **Revert to Factory Settings** menu item similarly allows you to change the settings back to AJA's factory defaults.

Operating AJA Mini-Config

The AJA Mini-Config application provides a graphic interface for viewing settings and updating software. It consists of an information area at the top that shows the available Mini-Converters attached to the computer via USB, with a graphical rendering of the selected Mini-Converter showing all the connectors and their current state.

Colored text next to the connectors indicates the signal type and what the Mini-Converter is doing:

- Blue text indicates the values automatically selected
- Black text indicates values that you have manually selected
- Red text indicates the Mini-Converter is not detecting a signal, or cannot operate with the current user settings.

NOTE: Even if no output device is detected, the SDI connector text still shows the signal it is outputting.

NOTE: Configuration settings in red will change based on the attached output device as well as input signals. For improved accuracy and reliability, you should configure the Mini-Converter only when the target output device is attached and input signals are supplied at the inputs.

Screens are virtually the same on both PC and Mac, with subtle differences that reflect the general look of the platform environment.

Figure 6. Example AJA Mini-Config Screen

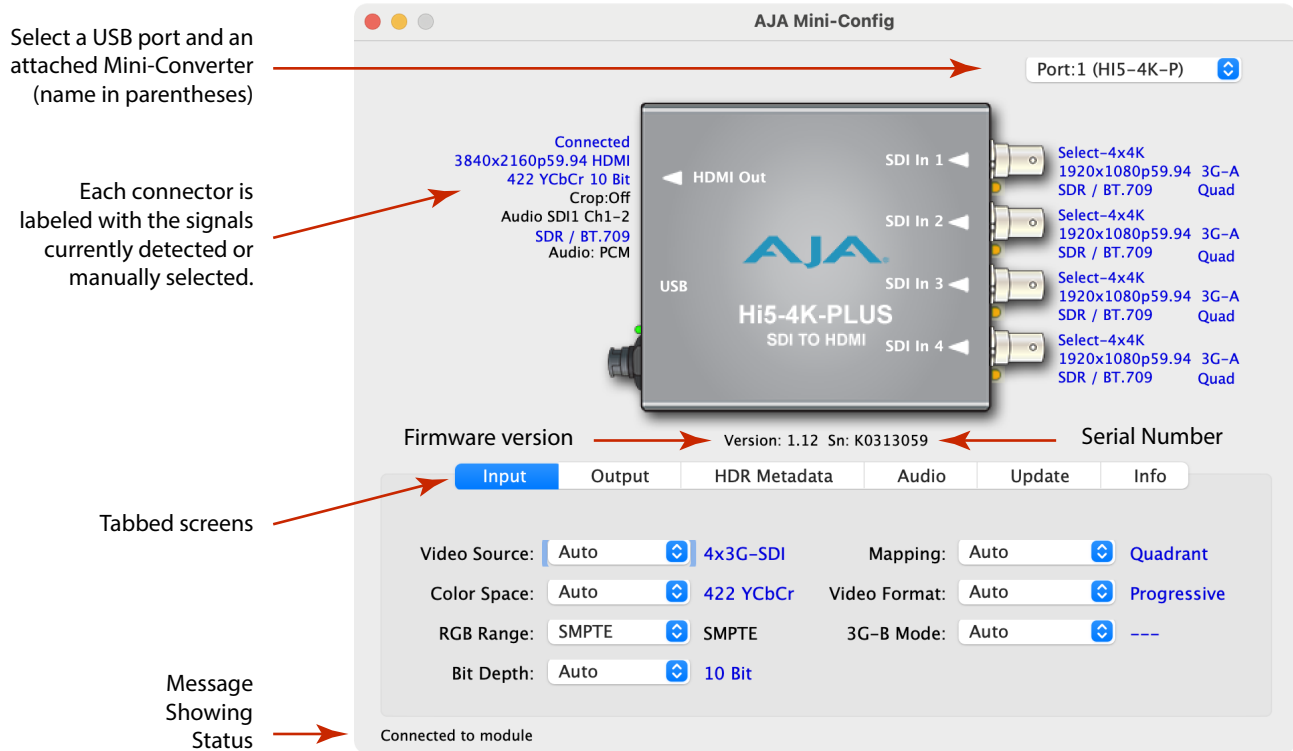

NOTE: The LEDs adjacent to each SDI connector indicate by color the detected signal type. Off is no signal, Green is SD-SDI, red is HD-SDI, and amber is 3G-SDI.

Selecting a Mini-Converter with the pulldown menu causes this application to connect to the selected converter. The graphic of Mini-Converter and text below it provides:

- Type of converter
- Firmware version
- Serial number of the unit.

A status field at the bottom of the screen shows if your application is connected and communicating with the Mini-Converter.

When configuring the Mini-Converter, select it from the top pulldown, view the current settings and change any values. Making a change communicates that new value to the Mini-Converter's non-volatile memory.

Tabbed Screens

The Tabs delineate control screens with groups of controls for each type of task to be performed. The controls for the actual configuration parameters are specific to each Mini-Converter type. When you Click on any of the tab buttons, the pane below the tabs will change to match your tab selection. Any changes you make are immediately applied and will be saved, overwriting previous settings.

Input Tab Screen

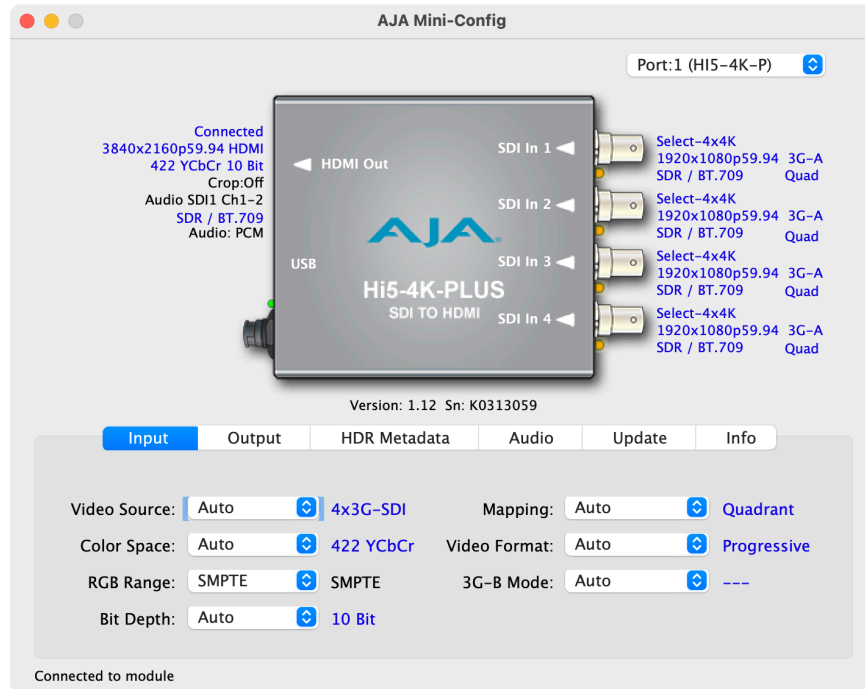

Click on the Input tab to view and make changes to the converter's input settings.

Video Source

Selects the input video source. Choose from the following:

- Auto - automatically selects the SDI input(s) to use based on validation of input signals from 7 possible SDI transport choices in the following order of priority:
 - 4x3G-SDI - Inputs 1, 2, 3, 4
 - 2x3G-SDI - Inputs 1, 2
 - 2x1.5G-SDI - Inputs 1, 2
 - SDI 1 - Input 1
 - SDI 2 - Input 2
 - SDI 3 - Input 3
 - SDI 4 - Input 4
- 4x3G-SDI
- 2x3G-SDI - (3G-B Dual Stream input required)
- 2x1.5G-SDI - (SMPTE 372 - Dual Link)
- SDI 1, SDI 2, SDI 3, or SDI 4

Color Space

Selects the Input Video Color Space. Choose from the following:

- Auto - automatically selects color mode based on the input video parameters and payload ID.
- 4:2:2 YCbCr
- 4:4:4 RGB
- 4:4:4 YCbCr

RGB Range

Selects the Input Video Color Range when the input is RGB. Does not apply when the input is YCbCr. Choose SMPTE or Full color range.

Bit Depth

Selects the input video bit depth. Choose Auto, 8-bit, 10-bit or 12-bit. Choosing "Auto" automatically selects the bit depth based on the input video parameters and the payload ID.

Mapping

Selects the 4K/UHD mapping format:

- Auto (default) -automatically selects the mapping based on the input video.
- 2SI - Two Sample Interleave
- Quadrant - Square Division

Video Format

Selects the Input Video Format. Choose from Auto, Progressive (P), Interlaced, or PsF (progressive segmented frame). Choosing "Auto" automatically selects the format based on the input video parameters and the payload ID.

3G-B Mode

Selects the 3G level B Video Mode. Choose from the following:

- Auto - automatically selects the format based on the input video parameters.
- Level B-DL - transmit using Level B Dual-Link format
- Level B-DS - transmit using Level B Dual-Stream format
- B-DS Link 1 - transmit using Level B Dual-Stream format, but only send Link 1
- B-DS Link 2 - transmit using Level B Dual-Stream format, but only send Link 2

Output Tab Screen

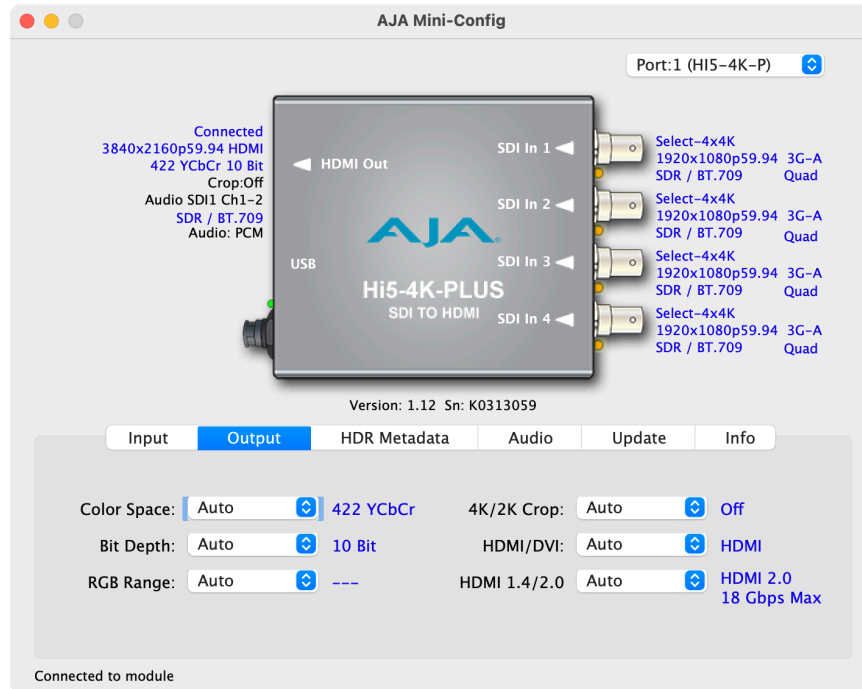

Click on the Output tab to view and make changes to the Hi5-4K-Plus Output settings.

Color Space

Selects the desired output video format. Choose from the following:

- Auto - selects the video format based on the input video and the attached device's capabilities.
- 4:2:2 YCbCr
- 4:4:4 RGB
- 4:4:4 YCbCr
- 4:2:0 YCbCr

Bit Depth

Choose from Auto, 8-bit, 10-bit or 12-bit. Choosing "Auto" automatically selects the bit depth based on the input video and the attached device's capabilities. High frame rate (HFR) 4K/UltraHD 4:4:4 limited to 8 bits.

RGB Range

Choose Auto, SMPTE or Full. Choosing "Auto" automatically selects the RGB output color range setting.

4K/2K Crop

Choose Auto, Off, or On. Provides the option of center cutting 2048x1080 video signals to make 1920x1080, or center cutting 4096x2160 signals to make 3840x2160.

HDMI/DVI

Choose Auto, HDMI, or DVI. When DVI is selected, any audio signals present are not passed. Choosing "Auto" automatically selects the output mode based on the attached device's capabilities.

HDMI 1.4/2.0

Choose Auto, HDMI 1.4, or HDMI 2.0.

Your selection for this control will depend on whether you are connected to a sink device that supports HDMI 2.0 (maximum bandwidth of 18 Gbps) or HDMI 1.4 (maximum bandwidth of 10.2 Gbps).

Hi5-4K-Plus supports HDMI 2.0 and can pass through 4K/UltraHD high frame rate (HFR) signals such as 50, 59.94 or 60.

- Auto (default setting). If connected to an HDMI 2.0 sink device, the 4K UHD HFR source will pass straight through with no loss of data. If connected to an HDMI 1.4 sink device, the unit will reduce its output data rate by dropping every other video frame, reducing bit depth, or both.
- HDMI 1.4. When the video source is 4K or UltraHD with a high frame rate (HFR) including 50, 59.94 or 60, the Hi5-4K-Plus will automatically drop every other video frame, reduce bit depth, or both. This setting can be used to support connection to an HDMI 1.4 sink device such as a monitor.
- HDMI 2.0. When the video source is 4K or UltraHD with a high frame rate (HFR) including 50, 59.94 or 60, the HDMI 2.0 setting supports the unit in passing through 4K/UltraHD high frame rate (HFR) signals such as 50, 59.94 or 60.

HDR Metadata Screen

The screenshot shows the AJA Mini-Config software interface. At the top, it displays "Port: 1 (HI5-4K-P)". The central part of the interface shows a 3D rendering of the Hi5-4K-Plus device with its ports labeled: HDMI Out, SDI In 1-4, and USB. To the left of the device, it shows connection status: "Connected 3840x2160p59.94 HDMI 422 YCbCr 10 Bit Crop:Off Audio SDI1 Ch1-2 SDR / BT.709 Audio: PCM". To the right, it lists four SDI input configurations, each set to "Select-4x4K 1920x1080p59.94 SDR / BT.709 3G-A Quad". Below the device rendering, it shows "Version: 1.12 Sn: K0313059".

The "HDR Metadata" tab is selected, showing the following settings:

| Input | Output | HDR Metadata | Audio | Update | Info |
|-----------------------------|---------|--------------|---------|----------|------|
| Custom HDMI Metadata | | | | | |
| Red: x[2] | 0.68000 | y[2] | 0.32000 | Presets | |
| Green: x[0] | 0.26500 | y[0] | 0.69000 | BT. 709 | |
| Blue: x[1] | 0.15000 | y[1] | 0.06000 | BT. 2020 | |
| White Pt: x | 0.31270 | y | 0.32900 | DCI-P3 | |
| DM Lum.: min | 0.0005 | max | 1000 | Reset | |
| Max: CLL | 1000 | FALL | 400 | | |
| Output Overrides | | | | | |
| SDR/HDR: | | Auto | SDR | | |
| Colorimetry: | | Auto | BT. 709 | | |
| HDMI Metadata: | | Auto | ----- | | |

Connected to module

Click on the HDR Metadata tab to view and, if necessary, make changes to the Hi5-4K-Plus High Dynamic Range metadata. For SDI this metadata defines the signal's Transfer Characteristic and Colorimetry. For HDMI it defines the signal's EOTF and Colorimetry and sets parameters for the Dynamic Range and Mastering infocode. The HDR metadata also provides a mechanism to inform an HDMI sink device (such as a TV or monitor) that the video content is HDR encoded.

NOTE: HDR Metadata values do not modify video image data. They define the HDR metadata included in the video output.

For most workflows the Auto settings for the Output Overrides parameters are appropriate, which will automatically pass incoming HDR metadata, if present, through to the output. However, this metadata may need to be edited for a specific workflow, or to correct inaccurate incoming metadata.

NOTE: You can hover the cursor over each parameter field to view its corresponding description in a pop-up window.

Custom HDMI Metadata

The twelve Custom HDMI Metadata parameters on the left side of the HDR Metadata tab can be used to define HDR color, white point, and luminance values.

*NOTE: These settings are only applied when the HDR Metadata parameter on the lower right is set to **Custom**. These values can be changed at any time (even with **Auto** selected), in which case those values will only be applied after selecting **Custom**.*

Red, Green, Blue, White Point

These eight values define the color gamut and white point, and are adjustable in units of 0.00002 cd/m², with a range of 0.00000 to 1.00000 cd/m².

Presets

For user convenience, the eight top values (RGB vertices and white point) can be preset to default **BT.709**, default **BT.2020** or default **DCI-P3** values.

DM Lum

These two parameters define the Display Mastering Luminance.

- Minimum: Defines the floor of the SMPTE ST 2086 color volume (in the case of HDR) and is determined by the mastering environment.
 - Range: 0.00000 cd/m² to 1.00000 cd/m².
 - Step size: 0.00002 cd/m².
- Maximum: Defines the ceiling of the SMPTE ST 2086 color volume (in the case of HDR) and is determined by the mastering environment.
 - Range: 1 cd/m² to 65535 cd/m².
 - Step size: 1 cd/m².

Maximum: CLL

Represents the highest-value pixel component in an entire scene. It is determined by analyzing each frame of video, and can be determined in the post environment.

- Range: 1 cd/m² to 65535 cd/m².
- Step size: 1 cd/m².

Maximum: FALL

Represents the maximum of frame-based average light levels taken over an entire scene, and can be determined in the post environment.

- Range: 1 cd/m² to 65535 cd/m².
- Step size: 1 cd/m².

Output Overrides

The override controls on the right can be used to replace incoming or missing HDR metadata with alternative values for the Hi5-4K-Plus's HDMI output.

SDR/HDR

This setting controls what SDR/HDR metadata value is applied to the video output.

- Auto - Passes the SDR/HDR value from the video input to the output.
- SDR - An SDR value is applied to the output.
- PQ - A PQ value is applied to the output.
- HLG - An HLG value is applied to the output.

Colorimetry

This setting controls what Colorimetry metadata value is applied to the video output.

- Auto - Passes the Colorimetry value from the video input to the output.
 - BT.601, BT.709 and BT.2020 values are passed through.
 - If a non-supported colorimetry value is received, then BT.601 is signaled for SD formats and BT.709 is signaled for HD/UltraHD formats.
- BT.709 - A BT.709 value is applied to the output.
- BT.2020 - A BT.2020 value is applied to the output.

HDMI Metadata

This setting can be used to insert custom metadata values on the HDMI output.

- Auto - The 8 RGB vertices/white point parameters that get inserted into the HDMI HDR Infoframe are automatically generated:
 - If the incoming Colorimetry value is BT.709, Color VANC Packet, or Unknown, then BT.709 values are passed to the output.
 - If the incoming Colorimetry value is BT.2020, BT.2020 values are passed to the output.
- Custom - The 8 RGB vertices/white point parameters defined on the left side of the screen are applied to the output.

NOTE: The four mastering parameters (Max CLL, etc) set in Mini-Config are always inserted into the HDMI HDR Infoframe, although HDMI HDR Infoframes are only generated if the SDR/HDR value is PQ or HLG.

Audio Tab Screen

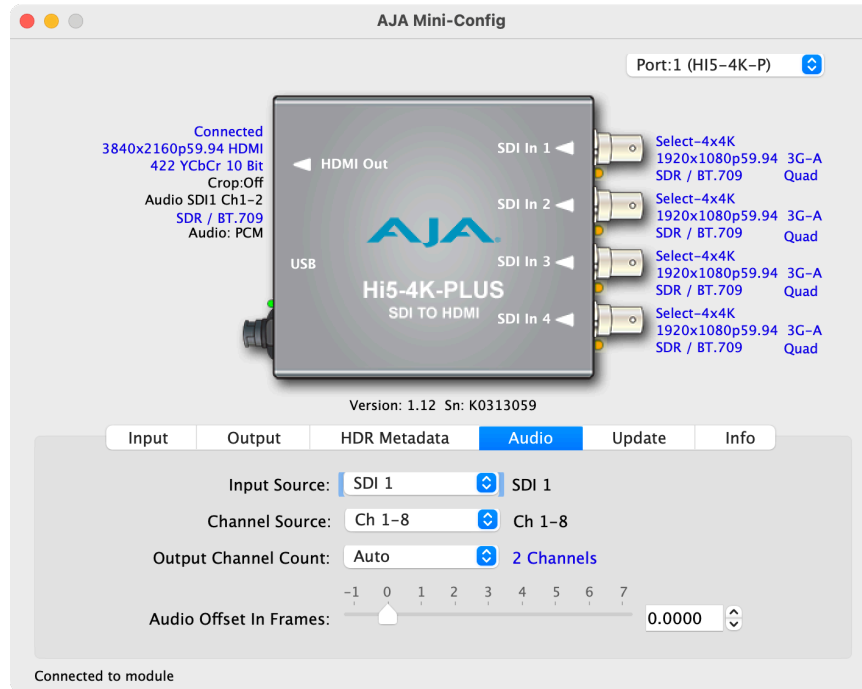

Click on the Audio tab to view and make changes to the Hi5-4K-Plus audio settings.

NOTE: When using the DVI video protocol, no audio is output since that protocol is video only.

Input Source

Choose which embedded audio channels are routed to the HDMI output. Eight channels are routed at a time. You can choose Ch 1-8 or Ch 9-16 from any of the SDI inputs.

Output Channel Count

Choose Auto, 2-channel or 8-channel embedded audio. Choosing “Auto” automatically selects the audio channels based on the attached device’s capabilities.

Audio Offset In Frames

Permits time shifting the embedded audio in relationship to the video (for example, to correct for lip sync problems), in 1/16 of a frame increments. Range is from -0.8125 video frame to +7.0 video frames. The actual time duration of delay will vary depending on the frame rate of the format being converted.

Update Tab Screen

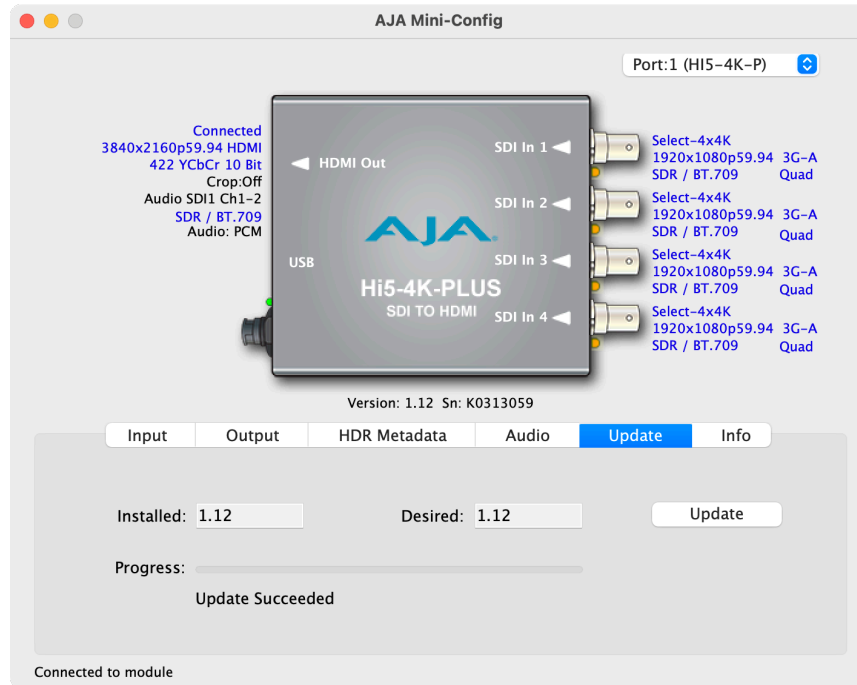

Use this Update screen to view the software version currently installed on the converter or install new software.

NOTE: When discussing Mini-Converters, “Firmware” is software that will be stored in the Mini-Converter’s non-volatile memory and used when it is powered up. This is something different than the AJA Mini-Config application software. The version numbers shown in the Update screen refer only to the firmware.

Installed - This field shows the version of the firmware currently installed inside the Mini-Converter.

Desired - This field shows the version of firmware embedded in the AJA Mini-Config application which you can install into the Mini-Converter by clicking the Update button.

Update

This button initiates a software update operation loading the “Desired” version of firmware into the Mini-Converter’s non-volatile memory.

Progress - This indicator bar shows the progress of firmware installation.

Software Update Procedure

1. Check the AJA website for new AJA Mini-Config software for your Mini-Converter. If new software is found, download it and uncompress the file archive (zip). Here is the URL to use when checking:
<https://www.aja.com/products/mini-config-software>
2. Connect the Mini-Converter to a Mac or PC via a USB port on the computer and run the new AJA Mini-Config software just downloaded.
3. Click on the Update tab screen.
4. Check the Installed version level against the Desired version level. If the Desired is newer, then click the Update button to download the new

firmware to the Mini-Converter; progress will be shown via the “Progress” thermometer bar.

Info Tab Screen

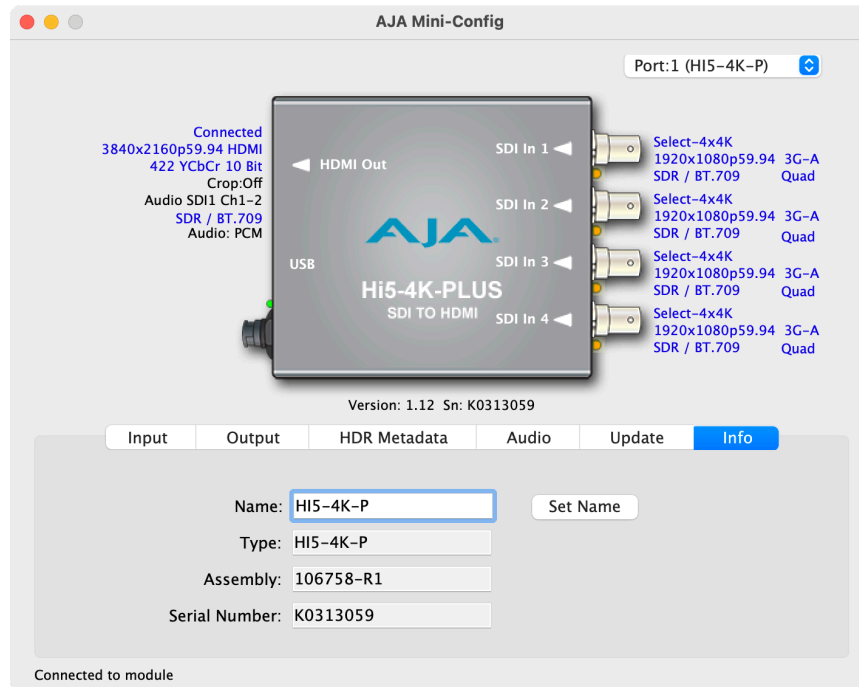

This screen provides basic information about the Mini-Converter. This information is useful when calling AJA Support for service or technical support.

Name

This field allows you to give your Mini-Converter a name. This can be useful if you have several Mini-Converters attached to a Mac/PC via USB so you can distinguish between them easily (especially if they're the same model).

Type - This is the factory set model name of the Mini-Converter.

Assembly - This is the factory assembly number.

Serial Number - This is the factory set unique serial number of your Mini-Converter. If you ever call AJA Support for service, you may be asked for this number.

Appendix A – Specifications

Video Formats

- (4K) 4096 x 2160p
- (UltraHD) 3840 x 2160p
- (2K) 2048 x 1080p
- (HD) 1920 x 1080p
- (HD) 1920 x 1080i
- (HD) 1280 x 720p
- (SD) 720 x 576i
- (SD) 720 x 480i

NOTE: Raster and Frame Rate Dependent, please see Hi5-4K-Plus Video Formats in Documents and Manual

Video Input Digital

- 4x 3G-SDI BNC, SMPTE-259/292/372/424
- YCbCr 4:2:2/4:4:4
- RGB 4:4:4, SMPTE or Full level
- 8, 10, or 12-bit
- Two Sample Interleave (2SI) or Square Division (Quadrant) source mapping
- 4x 3 Gb SDI (Level A or B-Dual Link)
 - (4K) 4096 x 2160p 23.98, 24, 25, 29.97, 30, 50, 59.94, 60
 - (4K) 4096 x 2160PsF* 23.98, 24, 25, 29.97, 30
 - (UltraHD) 3840 x 2160p 23.98, 24, 25, 29.97, 30, 50, 59.94, 60
 - (Ultra HD) 3840 x 2160PsF* 23.98, 24, 25, 29.97, 30
- 4x 1.5 Gb SDI
 - (4K) 4096 x 2160p 23.98, 24, 25, 29.97, 30
 - (4K) 4096 x 2160PsF 23.98, 24, 25, 29.97, 30
 - (UltraHD) 3840 x 2160p 23.98, 24, 25, 29.97, 30
 - (UltraHD) 3840 x 2160PsF 23.98, 24, 25, 29.97, 30
- 2x 3 Gb SDI (Level B-Dual Stream)
 - (4K) 4096 x 2160p 23.98, 24, 25, 29.97, 30
 - (4K) 4096 x 2160PsF 23.98, 24, 25, 29.97, 30
 - (UltraHD) 3840 x 2160p 23.98, 24, 25, 29.97, 30
 - (UltraHD) 3840 x 2160PsF 23.98, 24, 25, 29.97, 30
- 1x 3 Gb SDI (Level A or B-Dual Link)
 - (2K) 2048 x 1080p 23.98, 24, 25, 29.97, 30, 50, 59.94, 60
 - (2K) 2048 x 1080PsF 23.98, 24, 25, 29.97, 30
 - (HD) 1920 x 1080p 23.98, 24, 25, 29.97, 30, 50, 59.94, 60
 - (HD) 1920 x 1080PsF 23.98, 24, 25, 29.97, 30
 - (HD) 1920 x 1080i 50, 59.94, 60
 - (HD) 1280 x 720p** 50, 59.94, 60
- 2x 1.5 Gb SDI (Dual Link HD-SDI), SMPTE-372
 - (HD) 1920 x 1080p 50, 59.94, 60
- 1x 1.5 Gb SDI
 - (2K) 2048 x 1080p 23.98, 24, 25, 29.97, 30
 - (2K) 2048 x 1080PsF 23.98, 24, 25, 29.97, 30
 - (HD) 1920 x 1080p 23.98, 24, 25, 29.97, 30
 - (HD) 1920 x 1080PsF 23.98, 24, 25, 29.97, 30

- (HD) 1920 x 1080i 50, 59.94, 60
- (HD) 1280 x 720p 50, 59.94, 60
- 1x 270 Mb SDI
 - (SD) 625i 50
 - (SD) 525i 59.94

*PsF is Level B-Dual Link

**1280 x 720p is Level A Only

Video Output Digital

- 1x HDMI Type A connector*, HDMI v2.0b
- HDR infoframe generation with pass-through or override for Colorimetry and Transfer Characteristic
- YCbCr 4:2:2/4:4:4/4:2:0
- RGB 4:4:4, SMPTE or Full level
- 8, 10, or 12-bit (HFR 4K/UltraHD 4:4:4 limited to 8-bit)
- (4K) 4096 x 2160p 23.98, 24, 25, 29.97, 30, 50, 59.94, 60
- (UltraHD) 3840 x 2160p 23.98, 24, 25, 29.97, 30, 50, 59.94, 60
- (2K) 2048 x 1080p 23.98, 24, 25, 29.97, 30, 50, 59.94, 60
- (HD) 1920 x 1080p 23.98, 24, 25, 29.97, 30, 50, 59.94, 60
- (HD) 1920 x 1080i 50, 59.94, 60
- (HD) 1280 x 720p 50, 59.94, 60
- (SD) 720 x 576i 50
- (SD) 720 x 480i 59.94

*If a connected monitor doesn't support HDMI protocol the unit automatically switches to DVI protocol (which does not pass audio)

Audio Pass-Through Formats

- PCM
- Dolby Digital (AC-3)
- Dolby Digital Plus (E-AC-3), including Atmos Immersive Sound (JOC)

Audio Input Digital

- SDI embedded audio, 24-bit (SD limited to 20-bit), 16-channel

Audio Output Digital

- HDMI embedded audio, 24-bit, 8-channel

User Interface

- USB port used with supplied cable and Mini-Config software application to configure the device via Mac or Windows.

Size (w x d x h)

- 5.76" x 4.02" x 0.90" (146.31 x 102.11 x 22.86 mm)

Weight

- 0.6 lb (0.3 kg)

Power

- 5-20VDC regulated, 12 watts, power supply required, included with purchase
- AC Adapter: 100-240VAC, 50/60 Hz, universal input

Environment

- Safe Operating Temperature: 0 to 40 C (32 to 104 F)
- Safe Storage Temperature (Power OFF): -40 to 60 C (-40 to 140 F)
- Operating Relative Humidity: 10-90% noncondensing
- Operating Altitude: <3,000 meters (<10,000 feet)

NOTE: Hi5-4K-Plus uses approximately 12 watts of power and convection cooling. It will be very warm to the touch, which is normal. When installing the unit, mount in a location where it has access to air for proper cooling. Do not stack the Hi5-4K-Plus with other Mini-Converters.

Appendix B – Safety and Compliance

Federal Communications Commission (FCC) Compliance Notices

Class A Interference Statement

This equipment has been tested and found to comply with the limits for a Class A digital device, pursuant to Part 15, Subpart B of the FCC Rules. These limits are designed to provide reasonable protection against harmful interference in a residential installation. This equipment generates, uses, and can radiate radio frequency energy and, if not installed and used in accordance with the instructions, may cause harmful interference to radio communications. However, there is no guarantee that interference will not occur in a particular installation. If this equipment does cause harmful interference to radio or television reception, which can be determined by turning the equipment off and on, the user is encouraged to try to correct the interference by one or more of the following measures:

- Reorient or relocate the receiving antenna.
- Increase the separation between the equipment and receiver.
- Connect the equipment into an outlet on a circuit different from that to which the receiver is connected.
- Consult the dealer or an experienced radio/TV technician for help.

FCC Caution

This device complies with Part 15 of the FCC Rules. Operation is subject to the following two conditions: (1) This device may not cause harmful interference, and (2) this device must accept any interference received, including interference that may cause undesired operation.

Canadian ICES Statement

Canadian Department of Communications Radio Interference Regulations

This digital apparatus does not exceed the Class A limits for radio-noise emissions from a digital apparatus as set out in the Radio Interference Regulations of the Canadian Department of Communications. This Class A digital apparatus complies with Canadian ICES-003.

Règlement sur le brouillage radioélectrique du ministère des Communications

Cet appareil numérique respecte les limites de bruits radioélectriques visant les appareils numériques de classe A prescrites dans le Règlement sur le brouillage radioélectrique du ministère des Communications du Canada. Cet appareil numérique de la Classe A est conforme à la norme NMB-003 du Canada.

European Union and European Free Trade Association (EFTA) Regulatory Compliance

This equipment may be operated in the countries that comprise the member countries of the European Union and the European Free Trade Association. These countries, listed in the following paragraph, are referred to as The European Community throughout this document:

AUSTRIA, BELGIUM, BULGARIA, CYPRUS, CZECH REPUBLIC, DENMARK, ESTONIA, FINLAND, FRANCE, GERMANY, GREECE, HUNGARY, IRELAND, ITALY, LATVIA, LITHUANIA, LUXEMBOURG, MALTA, NETHERLANDS, POLAND, PORTUGAL, ROMANIA, SLOVAKIA, SLOVENIA, SPAIN, SWEDEN, UNITED KINGDOM, ICELAND, LICHTENSTEIN, NORWAY, SWITZERLAND

Declaration of Conformity

Marking by this symbol indicates compliance with the Essential Requirements of the EMC Directive of the European Union 2014/30/EU.



This equipment meets the following conformance standards:

Safety

EN 62368-1: 2014 + A11 (T-Mark License),
IEC 62368-1: 2014 (CB Scheme Certificate)

Emissions

EN 55032: 2012 + AC: 2013, CISPR 32: 2015,
EN 61000-3-2: 2014, EN 61000-3-3: 2013

Immunity

EN 55103-2: 2009, EN 61000-4-2: 2009, EN 61000-4-3: 2006+A1: 2008 + A2: 2010, EN 61000-4-4: 2004 + A1: 2010, EN 61000-4-5: 2006, EN 61000-4-6: 2009, EN 61000-4-11: 2004

Environments: E2, E3 and E4

The product is also licensed for additional country specific standards as required for the International Marketplace



Warning! This is a Class A product. In a domestic environment, this product may cause radio interference, in which case, the user may be required to take appropriate measures.

Achtung! Dieses ist ein Gerät der Funkstörgrenzwertklasse A. In Wohnbereichen können bei Betrieb dieses Gerätes Rundfunkstörungen auftreten, in welchen Fällen der Benutzer für entsprechende Gegenmaßnahmen verantwortlich ist.

Attention! Ceci est un produit de Classe A. Dans un environnement domestique, ce produit risque de créer des interférences radioélectriques, il appartiendra alors à l'utilisateur de prendre les mesures spécifiques appropriées..

Recycling Notice



This symbol on the product or its packaging indicates that this product must not be disposed of with your other household waste. Instead, it is your responsibility to dispose of your waste equipment by handing it over to a designated collection point for the recycling of waste electrical and electronic equipment. The separate collection and recycling of your waste equipment at the time of disposal will help conserve natural resources and ensure that it is recycled in a manner that protects human health and the environment. For more information about where you can drop off your waste for recycling, please contact your local authority, or where you purchased your product.

Korea KCC Compliance Statement

사용자 안내문

이 기기는 업무용 환경에서 사용할 목적으로 적합성평가를 받은 기기로서 가정용 환경에서 사용하는 경우 전파간섭의 우려가 있습니다.

Taiwan Compliance Statement

警告使用者：
這是甲類的資訊產品，在居住的環境中使用時，可能會造成射頻干擾，在這種情況下，使用者會被要求採取某些適當的對策。

This is a Class A product based on the standard of the Bureau of Standards, Metrology and Inspection (BSMI) CNS 13438, Class A. In a domestic environment this product may cause radio interference in which case the user may be required to take adequate measures.

Japanese Compliance Statement

この装置は、クラスA情報技術装置です。この装置を家庭環境で使用すると電波妨害を引き起こすことがあります。この場合には使用者が適切な対策を講ずるよう要求されることがあります。 VCCI-A

This is a Class A product based on the standard of the VCCI Council (VCCI-32: 2016). If this equipment is used in a domestic environment, radio interference may occur, in which case, the user may be required to take corrective actions.

Translated Warning and Caution Messages

The following caution statements, warning conventions, and warning messages apply to this product and manual.



Warning Symbol



Caution Symbol

Before Operation Please Read These Instructions



Warning! Read and follow all warning notices and instructions marked on the product or included in the documentation.

Avertissement! Lisez et conformez-vous à tous les avis et instructions d'avertissement indiqués sur le produit ou dans la documentation.

Warnung! Lesen und befolgen Sie die Warnhinweise und Anweisungen, die auf dem Produkt angebracht oder in der Dokumentation enthalten sind.

¡Advertencia! Lea y siga todas las instrucciones y advertencias marcadas en el producto o incluidas en la documentación.

Aviso! Leia e siga todos os avisos e instruções assinalados no produto ou incluídos na documentação.

Avviso! Leggere e seguire tutti gli avvisi e le istruzioni presenti sul prodotto o inclusi nella documentazione.



Warning! Do not use this device near water and clean only with a dry cloth.

Avertissement! N'utilisez pas cet appareil près de l'eau et nettoyez-le seulement avec un tissu sec.

Warnung! Das Gerät nicht in der Nähe von Wasser verwenden und nur mit einem trockenen Tuch säubern.

¡Advertencia! No utilice este dispositivo cerca del agua y límpielo solamente con un paño seco.

Aviso! Não utilize este dispositivo perto da água e limpe-o somente com um pano seco.

Avviso! Non utilizzare questo dispositivo vicino all'acqua e pulirlo soltanto con un panno asciutto.



Warning! Do not block any ventilation openings. Install in accordance with the manufacturer's instructions.

Avertissement! Ne bloquez aucune ouverture de ventilation. Suivez les instructions du fabricant lors de l'installation.

Warnung! Die Lüftungsöffnungen dürfen nicht blockiert werden. Nur gemäß den Anweisungen des Herstellers installieren.

¡Advertencia! No bloquee ninguna de las aberturas de la ventilación. Instale de acuerdo con las instrucciones del fabricante.

Aviso! Não obstrua nenhuma das aberturas de ventilação. Instale de acordo com as instruções do fabricante.

Avviso! Non ostruire le aperture di ventilazione. Installare in conformità con le istruzioni del fornitore.



Warning! Do not install near any heat sources such as radiators, heat registers, stoves, or other apparatus (including amplifiers) that produce heat.

Avertissement! N'installez pas l'appareil près d'une source de chaleur telle que des radiateurs, des bouches d'air de chauffage, des fourneaux ou d'autres appareils (amplificateurs compris) qui produisent de la chaleur.

Warnung! Nicht in der Nähe von Wärmequellen wie Heizkörpern, Heizregistern, Öfen oder anderen Wärme erzeugenden Geräten (einschließlich Verstärkern) aufstellen.

¡Advertencia! No instale cerca de fuentes de calor tales como radiadores, registros de calor, estufas u otros aparatos (incluidos amplificadores) que generan calor.

Aviso! Não instale perto de nenhuma fonte de calor tal como radiadores, saídas de calor, fogões ou outros aparelhos (incluindo amplificadores) que produzam calor.

Avviso! Non installare vicino a fonti di calore come termosifoni, diffusori di aria calda, stufe o altri apparecchi (amplificatori compresi) che emettono calore



Warning! Do not defeat the safety purpose of the polarized or grounding-type plug. A polarized plug has two blades with one wider than the other. A grounding type plug has two blades and a third grounding prong. The wide blade or the third prong are provided for your safety. If the provided plug does not fit into your outlet, consult an electrician for replacement of the obsolete outlet.

Avertissement! La sécurité de la prise polarisée ou de la prise de type mise à la terre ne doit en aucun cas être empêchée de fonctionner. Une prise polarisée a deux broches, l'une étant plus large que l'autre. Une prise de type mise à la terre a deux broches et une troisième broche pour la mise à la terre. La broche large ou la troisième broche sont fournies pour votre sécurité. Si la prise fournie ne s'insère pas dans votre prise femelle, consultez un électricien pour le remplacement de la prise femelle obsolète.

Warnung! Der Sicherheitszweck des gepolten bzw. Schukosteckers ist zu berücksichtigen. Ein gepolter Stecker verfügt über zwei Pole, von denen einer breiter als der andere ist. Ein Schukostecker verfügt neben den zwei Polen noch über einen dritten Pol zur Erdung. Der breite Pol bzw. der Erdungspol dienen der Sicherheit. Wenn der zur Verfügung gestellte Stecker nicht in Ihren Anschluss passt, konsultieren Sie einen Elektriker, um den veralteten Anschluss zu ersetzen.

¡Advertencia! No eche por tierra la finalidad del tipo de enchufe polarizado con conexión a tierra. Un enchufe polarizado tiene dos espigas, una más ancha que la otra. Un enchufe con conexión a tierra tiene dos espigas iguales y una tercera espiga que sirve para la conexión a tierra. La espiga ancha, o la tercera espiga, sirven para su seguridad. Si el enchufe suministrado no encaja en el tomacorriente, consulte con un electricista para reemplazar el tomacorriente obsoleto.

Aviso! Não anule a finalidade da segurança da ficha polarizada ou do tipo ligação terra. Uma ficha polarizada tem duas lâminas sendo uma mais larga do que a outra. Uma ficha do tipo de ligação à terra tem duas lâminas e um terceiro terminal de ligação à terra. A lâmina larga ou o terceiro terminal são fornecidos para sua segurança. Se a ficha fornecida não couber na sua tomada, consulte um electricista para a substituição da tomada obsoleta.

Avviso! Non compromettere la sicurezza della spina polarizzata o con messa a terra. Una spina polarizzata ha due spinotti, di cui uno più largo. Una spina con messa a terra ha due spinotti e un terzo polo per la messa a terra. Lo spinotto largo o il terzo polo sono forniti per motivi di sicurezza. Se la spina fornita non si inserisce nella presa di corrente, contattare un elettricista per la sostituzione della presa obsoleta.



Warning! Since the Mains plug is used as the disconnection for the device, it must remain readily accessible and operable.

Avertissement! Puisque la prise principale est utilisée pour débrancher l'appareil, elle doit rester aisément accessible et fonctionnelle.

Warnung! Da der Netzstecker als Trennvorrichtung dient, muss er stets zugänglich und funktionsfähig sein.

¡Advertencia! Puesto que el enchufe de la red eléctrica se utiliza como dispositivo de desconexión, debe seguir siendo fácilmente accesible y operable.

Aviso! Dado que a ficha principal é utilizada como a desconexão para o dispositivo, esta deve manter-se prontamente acessível e funcional.

Avviso! Poiché il cavo di alimentazione viene usato come dispositivo di sconnessione, deve rimanere prontamente accessibile e operabile.



Warning! Protect the power cord from being walked on or pinched particularly at plugs, convenience receptacles, and the point where they exit from the device.

Avertissement! Protégez le cordon d'alimentation pour que l'on ne marche pas dessus ou qu'on le pince, en particulier au niveau des prises mâles, des réceptacles de convenance, et à l'endroit où il sort de l'appareil.

Warnung! Vermeiden Sie, dass auf das Netzkabel getreten oder das Kabel geknickt wird, insbesondere an den Steckern, den Steckdosen und am Kabelausgang am Gerät.

¡Advertencia! Proteja el cable de energía para que no se le pise ni apriete, en especial cerca del enchufe, los receptáculos de conveniencia y el punto del que salen del equipo.

Aviso! Proteja o cabo de alimentação de ser pisado ou de ser comprimido particularmente nas fichas, em tomadas de parede de conveniência e no ponto de onde sai do dispositivo.

Avviso! Proteggere il cavo di alimentazione in modo che nessuno ci cammini sopra e che non venga schiacciato soprattutto in corrispondenza delle spine e del punto in cui esce dal dispositivo.



Warning! Refer all servicing to qualified service personnel. Servicing is required when the device has been damaged in any way, such as power-supply cord or plug is damaged, liquid has been spilled or objects have fallen into the device, the device has been exposed to rain or moisture, does not operate normally, or has been dropped.

Avertissement! Référez-vous au personnel de service qualifié pour tout entretien. L'entretien est exigé quand l'appareil a été endommagé de quelque manière que ce soit, par exemple lorsque le cordon d'alimentation ou la prise sont endommagés, que du liquide a été versé ou des objets sont tombés dans l'appareil, que l'appareil a été exposé à la pluie ou à l'humidité, ne fonctionne pas normalement ou est tombé.

Warnung! Das Gerät sollte nur von qualifizierten Fachkräften gewartet werden. Eine Wartung ist fällig, wenn das Gerät in irgendeiner Weise beschädigt wurde, wie bei beschädigtem Netzkabel oder Netzstecker, falls Flüssigkeiten oder Objekte in das Gerät gelangen, das Gerät Regen oder Feuchtigkeit ausgesetzt wurde, nicht ordnungsgemäß funktioniert oder fallen gelassen wurde.

¡Advertencia! Consulte al personal calificado por cuestiones de reparación. El servicio de reparación se requiere cuando el dispositivo ha recibido cualquier tipo de daño, por ejemplo cable o espigas dañadas, se ha derramado líquido o se han caído objetos dentro del dispositivo, el dispositivo ha sido expuesto a la lluvia o humedad, o no funciona de modo normal, o se ha caído.

Aviso! Remeta todos os serviços de manutenção para o pessoal de assistência qualificado. A prestação de serviços de manutenção é exigida quando o dispositivo foi danificado mediante qualquer forma, como um cabo de alimentação ou ficha que se encontra danificado/a, quando foi derramado líquido ou caíram objectos sobre o dispositivo, quando o dispositivo foi exposto à chuva ou à humidade, quando não funciona normalmente ou quando foi deixado cair.

Avviso! Fare riferimento al personale qualificato per tutti gli interventi di assistenza. L'assistenza è necessaria quando il dispositivo è stato danneggiato in qualche modo, ad esempio se il cavo di alimentazione o la spina sono danneggiati, è stato rovesciato del liquido è stato rovesciato o qualche oggetto è caduto nel dispositivo, il dispositivo è stato esposto a pioggia o umidità, non funziona correttamente o è caduto



Warning! Only use attachments and accessories specified and/or sold by the manufacturer.

Avertissement! Utilisez seulement les attaches et accessoires spécifiés et/ou vendus par le fabricant.

Warnung! Verwenden Sie nur Zusatzgeräte und Zubehör angegeben und / oder verkauft wurde durch den Hersteller.

¡Advertencia! Utilice solamente los accesorios y conexiones especificados y/o vendidos por el fabricante.

Aviso! Utilize apenas equipamentos/acessórios especificados e/ou vendidos pelo fabricante.

Avviso! Utilizzare soltanto i collegamenti e gli accessori specificati e/o venduti dal produttore.



Warning! Disconnect the external AC power supply line cord(s) from the mains power before moving the unit.

Avertissement! Retirez le ou les cordons d'alimentation en CA de la source d'alimentation principale lorsque vous déplacez l'appareil.

Warnung! Trennen Sie die Wechselstrom-Versorgungskabel vom Netzstrom, bevor Sie das Gerät verschieben.

¡Advertencia! Cuando mueva la unidad desenchufe de la red eléctrica el/los cable(s) de la fuente de alimentación CA tipo brick.

Advertência! Remova os cabos CA de alimentação brick da rede elétrica ao mover a unidade.

Avvertenza! Scollegare il cavo dell'alimentatore quando si sposta l'unità.



Warning! Unplug this device during lightning storms or when unused for long periods of time.

Avertissement! Débranchez cet appareil pendant les orages avec éclairs ou s'il est inutilisé pendant de longues périodes.

Warnung! Das Gerät ist bei Gewitterstürmen oder wenn es über lange Zeiträume ungenutzt bleibt vom Netz zu trennen.

¡Advertencia! Desenchufe este dispositivo durante tormentas eléctricas o cuando no se lo utilice por largos periodos del tiempo.

Aviso! Desconecte este dispositivo da tomada durante trovoadas ou quando não é utilizado durante longos períodos de tempo.

Avviso! Utilizzare soltanto i collegamenti e gli accessori specificati e/o venduti dal produttore, quali il treppiedi e l'esoscheletro.



Warning! Do not open the chassis. There are no user-serviceable parts inside.

Opening the chassis will void the warranty unless performed by an AJA service center or licensed facility.

Avertissement! Ne pas ouvrir le châssis. Aucun élément à l'intérieur du châssis ne peut être réparé par l'utilisateur. La garantie sera annulée si le châssis est ouvert par toute autre personne qu'un technicien d'un centre de service ou d'un établissement agréé AJA.

Warnung! Öffnen Sie das Gehäuse nicht. Keine der Geräteteile können vom Benutzer gewartet werden. Durch das Öffnen des Gehäuses wird die Garantie hinfällig, es sei denn, solche Wartungsarbeiten werden in einem AJA-Service-Center oder einem lizenzierten Betrieb vorgenommen.

¡Advertencia! No abra el chasis. El interior no contiene piezas reparables por el usuario. El abrir el chasis anulará la garantía a menos que se lo haga en un centro de servicio AJA o en un local autorizado.

Advertência! Não abra o chassi. Não há internamente nenhuma peça que permita manutenção pelo usuário. Abrir o chassi anula a garantia, a menos que a abertura seja realizada por uma central de serviços da AJA ou por um local autorizado.

Avvertenza! Non aprire lo chassis. All'interno non ci sono parti riparabili dall'utente. L'apertura dello chassis invaliderà la garanzia se non viene effettuata da un centro ufficiale o autorizzato AJA.

Warranty and Liability Information

Limited Warranty on Hardware.

AJA Video Systems, Inc. (AJA Video) warrants that the hardware product, not including software components, will be free from defects in materials and workmanship for a period of five years from the date of purchase. AJA Video provides a separate software warranty as part of the license agreement applicable to software components.

If the Customer brings a valid claim under this limited warranty for a hardware product (hereafter, a "product") during the applicable warranty period, AJA Video will, at its sole option and as the Customer's sole remedy for breach of the above warranty, provide one of the following remedies:

- Repair or facilitate the repair the product within a reasonable period of time, free of charge for parts and labor.
- Replace the product with a direct replacement or with a product that performs substantially the same function as the original product.
- Issue a refund of the original purchase price less depreciation to be determined based on the age of the product at the time remedy is sought under this limited warranty.

To obtain service under this warranty, the Customer must notify AJA Video of the defect before expiration of the warranty period and make suitable arrangements for the performance of service by contacting AJA Video support through the channels set forth on the support contacts web page at <https://www.aja.com/support>.

Except as stated, the Customer shall bear all shipping, packing, insurance and other costs, excluding parts and labor, to effectuate repair. Customer shall pack and ship the defective product to a service center designated by AJA Video, with shipping charges prepaid. AJA Video shall pay to return the product to Customer, but only if to a location within the country in which the AJA Video service center is located. SOME JURISDICTIONS DO NOT ALLOW THE EXCLUSION OF IMPLIED WARRANTIES OR LIMITATIONS ON APPLICABLE STATUTORY RIGHTS OF A CONSUMER, SO SOME OR ALL OF THE TERMS OF THIS PARAGRAPH MAY NOT APPLY TO YOU.

Limitation of Liability

Under no circumstances shall AJA video BE LIABLE IN ANY WAY FOR ANY LOST, CORRUPTED OR DESTROYED DATA, FOOTAGE OR WORK, OR FOR ANY OTHER INDIRECT, SPECIAL, INCIDENTAL OR CONSEQUENTIAL DAMAGES OR LOST PROFITS, OR FOR ANY THIRD PARTY CLAIM, IN CONNECTION WITH THE PRODUCT, WHETHER RESULTING FROM DEFECTS IN THE PRODUCT, SOFTWARE OR HARDWARE FAILURE, OR ANY OTHER CAUSE WHATSOEVER, EVEN IF AJA VIDEO HAS BEEN ADVISED OF THE POSSIBILITY OF SUCH DAMAGES. AJA VIDEO'S LIABILITY IN CONNECTION WITH THE PRODUCT SHALL UNDER NO CIRCUMSTANCES EXCEED THE PURCHASE PRICE PAID FOR THE PRODUCT. The foregoing limitations apply even if any remedy set forth in this LIMITED WARRANTY fails of its essential purpose. SOME JURISDICTIONS DO NOT ALLOW THE LIMITATION OF LIABILITY FOR PERSONAL INJURY, OR OF INCIDENTAL OR CONSEQUENTIAL DAMAGES, SO SOME OR ALL OF THE TERMS OF THIS PARAGRAPH MAY NOT APPLY TO YOU.

Governing Law and Language; Your Rights.

This limited warranty is the only warranty provided by AJA Video on the hardware product. It supersedes all prior or contemporaneous understandings regarding such subject matter. No amendment to or modification of this warranty will be binding unless in writing and signed by AJA Video. The laws of the State of California, USA will govern this warranty and any dispute arising from it. Any translation of this Agreement is intended for convenience and to meet local requirements and in the event of a dispute between the English and any non-English versions, the English version of this warranty will govern. This limited warranty gives you specific legal rights and you may have other rights that vary from jurisdiction to jurisdiction, some of which are noted above.

Index

A

- AJA Support 2
- Audio Tab Screen 19
 - Audio Offset In Frames 19
 - Input Source 19
 - Output Channel Count 19

B

- Block Diagram 6

C

- CLL
 - Maximum 17

F

- FALL
 - Maximum 17
- Features 5

H

- HDR Metadata Tab Screen 16
 - Colorimetry 18
 - Custom HDMI Metadata 17
 - DM Lum 17
 - HDMI Metadata 18
 - Maximum: CLL 17
 - Maximum: FALL 17
 - Output Overrides 18
 - SDR/HDR 18

I

- Info Tab Screen 21
- Input Tab Screen 13
 - 3G-B Mode 14
 - Bit Depth 14
 - Color Space 13
 - Mapping 14
 - RGB Range 14
 - Video Format 14
 - Video Source 13
- Installation 7
- I/O Connections 6

O

- Output Tab Screen 15
 - 4K/2K Crop 15
 - Bit Depth 15
 - Color Space 15
 - HDMI 1.4/2.0 16
 - HDMI/DVI 16
 - RGB Range 15
- Overview 4

T

- Technical Specifications 22

Technical Support 2

U

- Update Tab Screen 20
- USB Control and Setup 8