

# Leader

## LT 4610 / LT 4611 SYNC GENERATOR

LT 4610SER01	GPS/TC
LT 4610SER02	12G-SDI
LT 4610SER03	PTP
LT 4610SER04	GPS/BDS
LT 4610SER24	8K
LT 4611SER21	SYNC 3 OUT ADD
LT 4611SER22	SDI OUTPUT
LT 4611SER23	AUDIO OUTPUT
LT 4611SER24	8K

## Instruction Manual

Thank you for purchasing.

Please carefully read this instruction manual and the included "GENERAL SAFETY SUMMARY."  
Please use the product safely.

# TABLE OF CONTENTS

GENERAL SAFETY SUMMARY .....	I
1. INTRODUCTION .....	1
1.1 Scope of Warranty .....	1
1.2 Trademarks .....	1
1.3 Operating Precautions .....	2
1.3.1 Power Supply Voltage .....	2
1.3.2 Maximum Allowable Input Voltage .....	2
1.3.3 Mechanical Shock .....	2
1.3.4 Electrostatic Damage .....	2
1.3.5 Warming Up .....	2
1.4 Terminology Used in This Manual .....	3
2. PRODUCT CONFIGURATION .....	4
2.1 Main Unit .....	4
2.2 Hardware Options .....	4
2.3 Software Options .....	4
3. GENERAL .....	1
4. FEATURES .....	2
4.1 LT 4610 Main Unit .....	2
4.2 LT 4611 Main Unit .....	4
4.3 LT 4610SER01 (GPS/TC) .....	5
4.4 LT 4610SER02 (12G-SDI) .....	6
4.5 LT 4610SER03 (PTP) .....	7
4.6 LT 4610SER04 (GPS/BDS) .....	7
4.7 LT 4610SER24 (8K) .....	8
4.8 LT 4611SER21 (SYNC 3 OUT ADD) .....	8
4.9 LT 4611SER22 (SDI OUTPUT) .....	9
4.10 LT 4611SER23 (AUDIO OUTPUT) .....	9
4.11 LT 4611SER24 (8K) .....	10
5. SPECIFICATIONS .....	11
5.1 LT 4610 Main Unit .....	11
5.1.1 Compliant Standards .....	11
5.1.2 SDI Formats and Standards .....	11
5.1.3 I/O Connectors .....	13
5.1.4 Control Connectors .....	14
5.1.5 LCD .....	14
5.1.6 SDI Video Output .....	15
5.1.7 Genlock Function .....	18

5.1.8	Analog Video Sync Signal Output .....	19
5.1.9	AES/EBU Digital Audio Output .....	20
5.1.10	AES/EBU Silence Output .....	20
5.1.11	Word-Clock Output .....	20
5.1.12	Lip Sync Patterns .....	20
5.1.13	Preset Settings .....	21
5.1.14	Logging Feature.....	21
5.1.15	Internal Reference Generator .....	21
5.1.16	Internal Clock.....	21
5.1.17	General Specifications .....	21
5.2	LT 4611 Main Unit .....	22
5.2.1	Compliant Standards .....	22
5.2.2	I/O Connectors .....	22
5.2.3	Control Connectors .....	23
5.2.4	LCD.....	23
5.2.5	Genlock Function .....	24
5.2.6	Analog Video Sync Signal Output .....	25
5.2.7	Word-Clock Output .....	25
5.2.8	Preset Settings .....	25
5.2.9	Logging Feature.....	25
5.2.10	Internal Reference Generator .....	25
5.2.11	Internal Clock.....	26
5.2.12	General Specifications .....	26
5.3	LT 4610SER01 (GPS/TC) .....	27
5.3.1	GPS Lock .....	27
5.3.2	CW I/O.....	27
5.3.3	LTC I/O.....	27
5.3.4	Time Code .....	28
5.4	LT 4610SER02 (12G-SDI).....	29
5.4.1	Compliant Standards .....	29
5.4.2	SDI Formats and Standards .....	29
5.4.3	SDI Output Connector .....	35
5.4.4	SDI Pattern Generation.....	35
5.4.5	Lip Sync Patterns .....	40
5.4.6	User Payload ID .....	40
5.5	LT 4610SER03 (PTP) .....	41
5.5.1	Compliant Standards .....	41
5.5.2	RJ-45 Port .....	41
5.5.3	SFP / SFP+ Port.....	41
5.5.4	Master Function.....	41
5.5.5	Slave Function.....	42
5.6	LT 4610SER04 (GPS/BDS).....	43
5.6.1	GNSS Lock .....	43
5.6.2	CW I/O.....	43
5.6.3	LTC I/O.....	43
5.6.4	Time Code .....	44
5.7	LT 4611SER21 (SYNC 3 OUT ADD).....	45

5.7.1	Compliant Standards .....	45
5.7.2	Output Connectors .....	45
5.7.3	Analog Video Sync Signal Output .....	45
5.8	LT 4611SER22 (SDI OUTPUT) .....	46
5.8.1	Compliant Standards .....	46
5.8.2	SDI Formats and Standards .....	46
5.8.3	Output Connectors .....	48
5.8.4	SDI Video Output .....	48
5.8.5	Lip Sync Patterns .....	51
5.9	LT 4611SER23 (AUDIO OUTPUT) .....	52
5.9.1	Compliant Standards .....	52
5.9.2	Output Connectors .....	52
5.9.3	AES/EBU Digital Audio Output .....	52
5.9.4	AES/EBU Silence Output .....	52
5.10	LT 4610SER24 / LT 4611SER24 (8K) .....	53
5.10.1	Compliant Standard .....	53
5.10.2	SDI Formats and Standards .....	53
5.10.3	8K SDI Pattern Generation .....	54
5.10.4	Lip Sync Patterns .....	55
5.10.5	User Payload ID .....	55
5.11	Items Sold Separately .....	55
<b>6.</b>	<b>PANEL DESCRIPTION .....</b>	<b>56</b>
6.1	Front Panel .....	56
6.2	Rear Panel .....	57
<b>7.</b>	<b>BASIC OPERATION .....</b>	<b>58</b>
7.1	Turning the Power On .....	58
7.2	Attaching the Cover Inlet Stopper .....	60
7.3	Alarm Indications .....	61
7.4	Connecting a USB Memory Device .....	61
7.5	Installing the SFP / SFP+ Transceiver Module (SER03) .....	62
7.6	Signal I/O .....	63
7.6.1	Analog Video Sync Signal Output .....	63
7.6.2	SDI Signal Output .....	63
7.6.3	AES/EBU Signal Output .....	64
7.6.4	Word-Clock Signal Output .....	64
7.6.5	Genlock Signal Input .....	65
7.6.6	GPS Signal Input (SER01) .....	65
7.6.7	GNSS Signal Input (SER04) .....	66
7.6.8	CW Signal I/O (SER01/SER04) .....	66
7.6.9	LTC Signal I/O (SER01/SER04) .....	66
7.6.10	12G-SDI Signal Output (SER02) .....	68
7.6.11	PTP port (SER03) .....	68
7.7	Menu Operations .....	69
7.8	Genlock Operation .....	71

7.8.1	Internal Mode.....	71
7.8.2	Auto Format Mode .....	72
7.8.3	Manual Format Mode.....	74
7.8.4	GPS Mode (SER01) .....	75
7.8.5	GNSS Mode (SER04) .....	76
7.8.6	CW Mode (SER01/SER04).....	77
7.8.7	PTP Mode (SER03).....	78
<b>8.</b>	<b>STATUS MENU .....</b>	<b>79</b>
8.1	Genlock Status Display.....	80
8.2	Genlock Format Display.....	81
8.3	Alarm Display .....	82
8.4	Attention Display (SER01/SER04).....	85
8.5	Satellite Count Display (SER01/SER04).....	85
8.6	CN Display (SER01/SER04) .....	86
8.7	PTP Attention Display (SER03).....	86
8.8	PTP MASTER ID Display (SER03).....	86
8.9	PTP PHASE Display (SER03) .....	86
8.10	UTC Display (SER01/SER04).....	86
8.11	Local Time Display (SER01/SER04) .....	87
8.12	Internal Clock Display .....	87
<b>9.</b>	<b>INFO MENU .....</b>	<b>88</b>
9.1	Genlock Setting Display.....	89
9.2	Black Setting Display .....	90
9.3	SDI Setting Display .....	91
9.4	GPS Setting Display (SER01) .....	91
9.5	GNSS Setting Display (SER04) .....	91
9.6	12G Setting Display (SER02) .....	92
<b>10.</b>	<b>GENLOCK MENU.....</b>	<b>93</b>
10.1	Selecting the Genlock Mode .....	93
10.2	Selecting the Satellite (SER04).....	93
10.3	Selecting the Genlock Format .....	94
10.4	Adjusting the Timing .....	95
10.4.1	Adjusting the Timing (Frame).....	95
10.4.2	Adjusting the Timing (Line).....	95
10.4.3	Adjusting the Timing (Dot) .....	96
10.4.4	Finely Adjusting the Timing.....	96
10.5	Setting the Recovery Operation.....	97
10.5.1	Selecting the Recovery Mode.....	97
10.5.2	Selecting the Auto Setting.....	97
10.5.3	Selecting the Manual Setting .....	98
10.5.4	Setting the Relock.....	98
10.6	Setting the Genlock Log .....	99
10.6.1	Viewing the Log.....	99

10.6.2	Adding DETAIL and ALARM .....	100
10.6.3	Copying the Log to USB.....	101
10.6.4	Clearing the Log .....	101
<b>11.</b>	<b>BLACK MENU .....</b>	<b>102</b>
11.1	Selecting the Black Format .....	102
11.2	Adjusting the Timing .....	103
11.2.1	Adjusting the Timing (Frame).....	103
11.2.2	Adjusting the Timing (Line).....	103
11.2.3	Adjusting the Timing (Dot) .....	104
11.3	Turing the Time Code On and Off (SER01/SER04) .....	104
11.4	Common Black Signal Settings.....	104
<b>12.</b>	<b>SDI MENU .....</b>	<b>105</b>
12.1	Setting the SDI Format .....	105
12.1.1	Selecting the Image .....	105
12.1.2	Selecting the Color System .....	106
12.1.3	Selecting the Frame Frequency.....	106
12.2	Adjusting the Timing .....	107
12.2.1	Selecting the Timing Reference.....	107
12.2.2	Adjusting the Timing (Line).....	107
12.2.3	Adjusting the Timing (Dot) .....	108
12.3	Selecting the Pattern .....	109
12.4	Turning YCbCr On and Off .....	112
12.5	Turning Safety Area Markers On and Off .....	113
12.6	Configuring the Pattern Scroll Feature.....	114
12.6.1	Turning Scrolling On and Off.....	114
12.6.2	Setting the Vertical Scroll Speed .....	114
12.6.3	Setting the Horizontal Scroll Speed .....	115
12.7	Setting the Pattern Change.....	116
12.7.1	Turning Pattern Change On and Off.....	116
12.7.2	Setting the Pattern Change Speed.....	116
12.8	Setting ID Characters .....	117
12.8.1	Turning ID Characters On and Off .....	117
12.8.2	Recalling ID Characters .....	118
12.8.3	Creating ID Characters .....	118
12.8.4	Setting the Vertical Position of ID Characters.....	119
12.8.5	Setting the Horizontal Position of ID Characters.....	119
12.8.6	Selecting the Size of ID Characters .....	120
12.8.7	Selecting the Level of ID Characters.....	120
12.8.8	Turning ID Character Blinking On and Off.....	121
12.8.9	Setting the ID Character On-Time.....	121
12.8.10	Setting the ID Character Off-Time.....	121
12.8.11	Turning ID Character Scrolling On and Off.....	122
12.8.12	Setting ID Character Scroll Speed .....	122
12.8.13	Saving ID Characters.....	123

12.8.14	Copying ID Characters to the LT 4610 .....	124
12.8.15	Copying ID Characters to a USB Memory Device.....	125
12.8.16	Clearing ID Characters .....	126
12.9	Setting Logos .....	127
12.9.1	Display procedure .....	128
12.9.2	Turning the Logo On and Off .....	129
12.9.3	Selecting a Logo .....	130
12.9.4	Setting the Vertical Logo Position .....	130
12.9.5	Setting the Horizontal Logo Position .....	131
12.9.6	Setting the Logo Level.....	131
12.9.7	Setting the Logo Transparency .....	132
12.9.8	Copying Logos to the LT 4610 .....	133
12.9.9	Copying Logos to a USB Memory Device.....	134
12.9.10	Clearing a Logo .....	135
12.10	Configuring Embedded Audio.....	136
12.10.1	Turning the Audio On and Off .....	137
12.10.2	Selecting the Resolution.....	137
12.10.3	Selecting the Pre-emphasis Mode .....	138
12.10.4	Selecting the Frequency .....	138
12.10.5	Setting the Level.....	139
12.10.6	Setting Clicks .....	139
12.10.7	Settings Shared by Links.....	140
12.10.8	Settings Shared by Groups.....	140
12.10.9	Settings Shared by Channels .....	141
12.11	Turing the Time Code On and Off (SER01/SER04) .....	142
12.12	Common SDI Signal Settings .....	142
13.	AES/EBU MENU.....	143
13.1	Setting the AES/EBU Output.....	143
13.1.1	Turning the Audio Output On and Off .....	143
13.1.2	Selecting the Frequency .....	143
13.1.3	Setting the Level.....	144
13.1.4	Setting Clicks .....	144
13.1.5	Settings Shared by Channels.....	144
13.1.6	Selecting the Resolution.....	145
13.1.7	Selecting the Pre-emphasis Mode .....	145
13.1.8	Turing the Time Code On and Off.....	145
13.1.9	Adjusting the Timing .....	146
13.2	Setting the Silence Output.....	146
13.2.1	Selecting the Resolution.....	146
13.2.2	Adjusting the Timing .....	146
14.	WCLK MENU .....	147
14.1	Adjusting the Timing .....	147
15.	ETC MENU.....	148

15.1	Turning Lip Sync On and Off .....	148
15.2	Description of Lip Sync Patterns .....	149
<b>16.</b>	<b>GPS OPTION MENU (SER01) .....</b>	<b>150</b>
16.1	Setting the LTC Output .....	150
16.1.1	Turing the Time Code Output On and Off .....	150
16.1.2	Adjusting the Time Code Output Timing (Frame) .....	150
16.1.3	Adjusting the Time Code Output Timing (Bit) .....	151
16.1.4	Adjusting the LTC2 Offset .....	151
16.1.5	Adjusting the LTC3 Offset .....	151
16.1.6	Setting the CW I/O .....	152
16.1.7	Selecting Input or Output .....	152
16.1.8	Selecting the Output Frequency .....	152
<b>17.</b>	<b>GNSS OPTION MENU (SER04) .....</b>	<b>153</b>
17.1	Setting the LTC Output .....	153
17.1.1	Turing the Time Code Output On and Off .....	153
17.1.2	Adjusting the Time Code Output Timing (Frame) .....	153
17.1.3	Adjusting the Time Code Output Timing (Bit) .....	154
17.1.4	Adjusting the LTC2 Offset .....	154
17.1.5	Adjusting the LTC3 Offset .....	154
17.1.6	Setting the CW I/O .....	155
17.1.7	Selecting Input or Output .....	155
17.1.8	Selecting the Output Frequency .....	155
<b>18.</b>	<b>12G OPTION MENU (SER02) .....</b>	<b>156</b>
18.1	Setting the SDI Format .....	156
18.1.1	Selecting the System .....	157
18.1.2	Selecting the Color System .....	158
18.1.3	Selecting the Frame Frequency .....	158
18.2	Adjusting the Timing .....	159
18.2.1	Adjusting the Timing (Line) .....	159
18.2.2	Adjusting the Timing (Dot) .....	159
18.3	Selecting the Pattern .....	160
18.3.1	Switching between Fixed Pattern and User Pattern .....	160
18.3.2	Selecting the Fixed Pattern .....	161
18.3.3	Operating procedure a user pattern .....	164
18.3.4	Displaying a User Pattern .....	165
18.3.5	Selecting a User Pattern .....	167
18.3.6	Deleting a User Pattern .....	168
18.3.7	Copying a User Pattern to the LT 4610 .....	169
18.3.8	Copying a User Pattern to a USB Memory Device .....	171
18.3.9	Copying Patterns from the Archive .....	172
18.4	Turning YCbCr On and Off .....	174
18.5	Turning Safety Area Markers On and Off .....	174
18.6	Configuring the Pattern Scroll Feature .....	174



18.7	Setting the Pattern Change.....	174
18.8	Setting ID Characters .....	174
18.9	Setting Logos .....	174
18.10	Setting the Moving Box .....	175
18.10.1	Turning the Moving Box On and Off.....	175
18.10.2	Setting the Box Color .....	175
18.10.3	Setting the Vertical Moving Speed.....	175
18.10.4	Setting the Horizontal Moving Speed .....	176
18.10.5	Setting the Vertical Box Size.....	176
18.10.6	Setting the Horizontal Box Size.....	176
18.11	Turning Lip Sync On and Off .....	177
18.12	Turning User Payload ID On and Off .....	178
18.13	Configuring Embedded Audio.....	178
18.14	Common SDI Signal Settings .....	178
19.	8K OPTION MENU (SER24).....	179
19.1	Setting the SDI Format .....	179
19.1.1	Selecting the System.....	179
19.1.2	Selecting the Color System .....	179
19.1.3	Selecting the Frame Frequency.....	180
19.2	Adjusting the Timing .....	181
19.3	Selecting the Pattern .....	181
19.3.1	Switching between Fixed Pattern and User Pattern.....	181
19.3.2	Selecting the Fixed Pattern.....	181
19.3.3	Operating procedure a user pattern .....	183
19.3.4	Displaying a User Pattern.....	183
19.3.5	Selecting a User Pattern .....	185
19.3.6	Deleting a User Pattern.....	186
19.3.7	Copying a User Pattern to the LT 4610 .....	187
19.3.8	Copying a User Pattern to a USB Memory Device .....	189
19.3.9	Copying Patterns from the Archive.....	190
19.4	Turning YCbCr On and Off .....	191
19.5	Turning Safety Area Markers On and Off .....	191
19.6	Configuring the Pattern Scroll Feature.....	191
19.7	Setting the Pattern Change.....	191
19.8	Setting the Moving Box .....	191
19.9	Turning Lip Sync On and Off .....	192
19.10	Turning User Payload ID On and Off .....	192
19.11	Configuring Embedded Audio.....	192
20.	PTP OPTION MENU (SER03) .....	193
20.1	PTP Master.....	193
20.1.1	Setting the Mode .....	193
20.1.2	Setting the BMCA.....	193
20.1.3	Setting the Profile Type .....	194
20.1.4	Profile Default Settings .....	194

20.1.5	Setting the Domain .....	194
20.1.6	Setting the Communication Mode .....	195
20.1.7	Setting the Announce Interval .....	196
20.1.8	Setting the Sync Interval .....	196
20.1.9	Setting Priority 1.....	197
20.1.10	Setting Priority 2.....	197
20.1.11	Setting the Step .....	197
20.1.12	Setting ST2059 (PROFILE: ST2059 only) .....	198
20.1.13	Setting the Announce Timeout .....	199
20.1.14	Setting the Propagation Time Measurement Method.....	199
20.2	PTP Slave.....	200
20.2.1	Setting the Mode .....	200
20.2.2	Setting the Profile Type .....	200
20.2.3	Profile Default Settings .....	200
20.2.4	Setting the Domain .....	201
20.2.5	Setting the Communication Mode .....	201
20.2.6	Setting the Desired Announce Message Transmission Interval (UNICAST only) .....	202
20.2.7	Setting the Minimum Interval for Receiving Announce Messages (UNICAST only) .....	202
20.2.8	Setting the Desired Sync Message Transmission Interval (UNICAST only) .....	203
20.2.9	Setting the Minimum Interval for Receiving Sync Messages (UNICAST only).....	203
20.2.10	Setting the Delay Message Interval (MULTICAST, MIXED SMPTE w/o NEGOTIATION) .....	204
20.2.11	Setting the Desired Delay Response Transmission Interval (Mixed SMPTE, UNICAST) .....	204
20.2.12	Setting the Minimum Interval for Receiving Delay Responses (Mixed SMPTE, UNICAST) 205	
20.2.13	Setting the Announce Timeout .....	205
20.2.14	Setting the Propagation Time Measurement Method.....	206
20.2.15	Setting the IP Address of the Master to Connect To (Mixed SMPTE w/o Negotiation, UNICAST).....	206
20.2.16	Setting the Asymmetric Delay .....	206
21.	SYSTEM MENU .....	207
21.1	Setting the Backlight .....	207
21.2	Turning Key Lock On and Off .....	207
21.3	Configuring Presets .....	208
21.3.1	Loading Presets .....	208
21.3.2	Saving Presets.....	209
21.3.3	Power-on Settings.....	209
21.3.4	Copying Presets to the LT 4610 .....	210
21.3.5	Copying Presets to a USB Memory Device .....	211
21.3.6	Clearing Presets.....	211
21.4	Configuring Ethernet Settings .....	212
21.4.1	Setting the IP Address.....	212
21.4.2	Viewing the MAC Address .....	212
21.4.3	Turning TRAP Transmission On and Off.....	212
21.4.4	Setting the Trap Transmission Destination.....	213
21.4.5	Copying MIB Files to a USB Memory Device .....	213
21.4.6	Setting READ COMMUNITY.....	214

21.4.7	Setting WRITE COMMUNITY .....	214
21.4.8	Setting TRAP COMMUNITY .....	215
21.4.9	Restarting SNMP .....	215
21.5	Setting the PTP Ethernet Parameters (SER03) .....	216
21.5.1	Setting the PTP IP Address.....	216
21.5.2	Setting the PTP Subnet Mask.....	216
21.5.3	Setting the PTP Gateway .....	216
21.5.4	Viewing the PTP MAC Address .....	217
21.5.5	Viewing the PTP CLOCK IDENTITY .....	217
21.5.6	Setting SFP/SFP+ .....	217
21.5.7	Setting PORT RELATION .....	218
21.6	Date and time settings.....	219
21.6.1	Selecting the Date and Time .....	219
21.6.2	Adjusting the Date and Time.....	220
21.7	Setting the Time Code (SER01/SER03/SER04).....	221
21.7.1	Selecting the Time Code .....	221
21.7.2	Setting Dropped Frames .....	222
21.7.3	Turning Jam Sync On and Off .....	222
21.7.4	Setting the Jam Sync Time.....	223
21.7.5	Turning the Daylight Savings Time On and Off.....	223
21.7.6	Setting the Daylight Savings Time Start Date .....	223
21.7.7	Setting the Daylight Saving Time Offset.....	224
21.7.8	Setting the Daylight Savings Time End Date.....	224
21.7.9	Setting the Leap Second .....	224
21.8	Setting GPS/PTP or GNSS / PTP (applies to both SER01 and SER03, or SER04/SER03) ....	225
21.8.1	Selecting the Time Zone .....	225
21.8.2	Setting the Power Supply .....	226
21.8.3	Selecting the Operating Environment (SER01).....	226
21.8.4	Selecting the Epoch.....	226
21.9	Setting the Alarm (SER01/SER04).....	227
21.9.1	Selecting the Polarity.....	227
21.9.2	Turning the Alarm Output On and Off .....	228
21.10	Turning the Web Browser On and Off.....	228
21.11	Initialization.....	229
21.11.1	Initializing Settings.....	229
21.11.2	Factory Default Initialization.....	230
21.11.3	Selecting the Format .....	230
21.12	Viewing the Serial Numbers.....	231
21.13	Viewing and Installing Software Options .....	232
21.13.1	Viewing Software Options .....	232
21.13.2	Installing Software Options .....	232
21.14	Viewing the Version Information .....	233
<b>22.</b>	<b>LOGO APP .....</b>	<b>234</b>
22.1	Installation .....	234
22.2	Uninstallation.....	236
22.3	How to Use .....	237

23. HTTP .....	241
23.1 Operating Environment .....	241
23.2 How to Use .....	241
23.2.1 STATUS tab .....	242
23.2.2 GENLOCK tab .....	242
23.2.3 BLACK tab .....	242
23.2.4 SDI tab .....	242
23.2.5 AES/EBU tab .....	242
23.2.6 WCLK tab .....	242
23.2.7 ETC tab .....	242
23.2.8 SYSTEM tab .....	242
23.2.9 GPS tab .....	242
23.2.10 GNSS tab .....	243
23.2.11 12G SDI tab .....	243
23.2.12 Editing User Payload ID .....	243
23.2.13 Uploading User Pattern .....	244
23.2.14 PTP tab .....	246
24. SNMP .....	247
24.1 SNMP Version .....	247
24.2 SMI Definitions .....	247
24.3 How to Use .....	247
24.4 Enterprise MIB .....	248
24.4.1 status Group .....	252
24.4.2 genlockRef Group .....	253
24.4.3 black*Ref Group .....	254
24.4.4 sdi*Format Group .....	255
24.4.5 sdi*Timing Group .....	256
24.4.6 sdi*Pattern Group .....	256
24.4.7 sdi*Component Group .....	256
24.4.8 sdi*SafetyArea Group .....	256
24.4.9 sdi*Scroll Group .....	257
24.4.10 sdi*PatternChange Group .....	257
24.4.11 sdi*Id Group .....	257
24.4.12 sdi*Logo Group .....	257
24.4.13 sdi*Audio Group .....	257
24.4.14 Lipsync Group .....	257
24.4.15 gpsStat Group (*1) .....	258
24.4.16 gpsRef Group (*1) .....	258
24.4.17 presetRef Group .....	258
24.4.18 target Group .....	258
24.4.19 sdi12g*Format Group .....	259
24.4.20 sdi12g*Timing Group .....	260
24.4.21 sdi12g*Pattern Group .....	260
24.4.22 sdi12g*Component Group .....	260
24.4.23 sdi12g*SafetyArea Group .....	261

24.4.24	sdi12g*Scroll Group .....	261
24.4.25	sdi12g*PatternChange Group .....	261
24.4.26	sdi12g*Id Group .....	262
24.4.27	sdi12g*Logo Group .....	263
24.4.28	sdi12g*MvBox Group .....	264
24.4.29	sdi12g *Audio Group .....	265
24.4.30	sdi12g*Lipsync Group .....	265
24.4.31	ptp*Mode Group .....	265
24.4.32	ptp*ProfileType Group .....	265
24.4.33	ptp*ProfileDefault Group.....	266
24.4.34	ptp*Domain Group.....	266
24.4.35	ptp*ComminucationMode Group .....	266
24.4.36	ptp*AnnoumceInterval Group.....	266
24.4.37	ptp*SyncInterval Group .....	266
24.4.38	ptp*AnnounceTimeout Group .....	266
24.4.39	ptp*Priority1 Group.....	267
24.4.40	ptp*Priority2 Group.....	267
24.4.41	ptp*Step Group .....	267
24.4.42	ptp*DefaultFrame Group .....	267
24.4.43	ptp*DropFrameFlag Group .....	267
24.4.44	ptp*ColorFrameId Group .....	267
24.4.45	ptp*DelayMechanism Group .....	267
24.4.46	ptp*AmtConfiguration1 Group.....	268
24.4.47	ptp*AmtConfiguration2 Group.....	268
24.4.48	ptp*AmtConfiguration3 Group.....	268
24.4.49	ptp*AmtConfiguration4 Group.....	268
24.4.50	ptp*AmtConfiguration5 Group.....	268
24.4.51	ptp*AmtConfiguration6 Group.....	268
24.4.52	ptp*AmtConfiguration7 Group.....	268
24.4.53	ptp*AmtConfiguration8 Group.....	268
24.4.54	ptp*AsymmetricDelay Group .....	268
24.4.55	ptp*DelayMsgInterval Group .....	269
24.4.56	ptp*AnnounceDesirInt Group .....	269
24.4.57	ptp*AnnounceReqdInt Group .....	269
24.4.58	ptp*SyncDesirInt Group .....	270
24.4.59	ptp*SyncReqdInt Group.....	270
24.4.60	ptp*DlyMsgDesirInt Group .....	270
24.4.61	ptp*DlyMsgReqdInt Group .....	271
24.4.62	ptp*Bmca Group.....	271
24.4.63	ptpSystemIpAddress Group.....	271
24.4.64	ptpSystemSubnetMask Group.....	271
24.4.65	ptpSystemGateway Group.....	271
24.4.66	ptpSystemSwitch Group.....	271
24.4.67	ptpSystemSfpSfpp Group .....	271
24.5	Extended TRAP .....	272

25.	APPENDIX .....	273
-----	----------------	-----

25.1	List of Settings.....	273
25.1.1	GENLOCK Menu .....	273
25.1.2	BLACK menu .....	273
25.1.3	SDI menu .....	274
25.1.4	AES/EBU menu.....	275
25.1.5	WCLK Menu .....	275
25.1.6	ETC Menu .....	275
25.1.7	GPS OPTION Menu / GNSS OPTION Menu .....	276
25.1.8	12G OPTION menu .....	276
25.1.9	PTP OPTION Menu .....	278
25.1.10	SYSTEM Menu .....	281
25.2	Menu Tree .....	282
25.2.1	STATUS Menu.....	282
25.2.2	INFO Menu .....	283
25.2.3	GENLOCK Menu .....	285
25.2.4	BLACK Menu .....	286
25.2.5	SDI Menu .....	287
25.2.6	AES/EBU Menu .....	290
25.2.7	WCLK Menu .....	290
25.2.8	ETC Menu .....	290
25.2.9	GPS OPTION Menu.....	291
25.2.10	GNSS OPTION Menu.....	292
25.2.11	12G OPTION Menu.....	293
25.2.12	PTP OPTION Menu .....	299
25.2.13	SYSTEM menu.....	304
25.3	Firmware Update History .....	309

# GENERAL SAFETY SUMMARY

## ■ Read This before Using the Instrument

This instrument should only be used by persons with sufficient knowledge of electronics who thoroughly understand the contents of this manual.



This instrument is not designed or manufactured for households or ordinary consumers. If unqualified personnel are to use the instrument, be sure the instrument is handled under the supervision of qualified personnel (those who have electrical knowledge). This is to prevent the possibility of personal injury or damage to the instrument.

## ■ Note about Reading This Manual

The contents of this manual contain specialized terminology and may be difficult to understand. If you have any questions about the contents of this manual, please contact your local LEADER agent.

## ■ Symbols and Terms

The following symbols and terms are used in this instruction manual and on the instrument to indicate important warnings and notes.

<p>&lt;Symbol&gt;</p> 	<p>This symbol appears in this instruction manual and on the instrument to indicate an area where improper handling could result in personal injury, damage to the instrument, or malfunction of the instrument or devices connected to it.</p> <p>When you encounter this symbol on the instrument, be sure to refer to the information in this instruction manual that corresponds to the area that the symbol marks.</p>
<p>&lt;Term&gt;</p> 	<p>Ignoring the precautions that this term indicates could lead to death or serious injury.</p>
<p>&lt;Term&gt;</p> 	<p>Ignoring the precautions that this term indicates could lead to personal injury or damage to the instrument.</p>

# GENERAL SAFETY SUMMARY

Read the warnings and information below thoroughly to avoid death, personal injury, and damage and deterioration of the instrument.



## ■ Warnings Concerning the Case and Panels

Do not remove the instrument's case or panels for any reason. Touching the internal components of the instrument could lead to fire or electric shock.

Also, do not allow foreign materials, such as liquids, combustible matter, and metal, to enter the instrument. Turning the instrument on when such materials are inside it could lead to fire, electric shock, damage to the instrument, or some other accident.

## ■ Installation Environment

### • Operating Temperature Range

Use this instrument in a 0 to 40 °C environment. Using the instrument with its vents blocked or in a high temperature environment could lead to fire.

Drastic changes in temperature, such as might be caused by moving the instrument between two rooms with different temperatures, can damage the instrument by causing condensation to form within it. If there is a possibility that the instrument has condensation within it, wait for approximately 30 minutes before turning on the power.

### • Operating Humidity Range

Use this instrument in an environment whose relative humidity is 85 % or less where there is no threat of condensation forming.

Also, do not operate this instrument with wet hands. Doing so could lead to electric shock or fire.

### • Do Not Operate in an Explosive Atmosphere

Using this instrument in an environment where flammable gases, explosive gases, or steam is emitted or stored could lead to an explosion or fire. Do not use the instrument in such an environment.

### • Do Not Insert Foreign Materials

Do not insert foreign materials, such as metal and flammable objects, through the vents or allow liquid to enter the instrument. Such acts can lead to fire, electric shock, damage to the instrument, or some other accident.

## ■ If You Notice Something Wrong during Operation

If you notice smoke, fire, a strange smell, or something else that is wrong with the instrument while you are operating it, stop operation immediately. Failing to do so could lead to fire. Turn OFF the power switch, and remove the power cord from the outlet. After making sure that fire has not spread anywhere, contact your local LEADER agent.



# GENERAL SAFETY SUMMARY



## ■ Warnings Concerning the Power Source

Do not use a power source with a voltage other than the rated power source voltage for the instrument. Doing so could lead to fire.

Confirm the voltage of the power source before you connect the power cord to it.

Only use a power source whose frequency is 50/60 Hz.

Use a power cord that is appropriate for the voltage of the power source. Also, use a power cord that meets the safety standards of the country that you are using it in.

Using a power cord that does not meet the standards could lead to fire. If the power cord is damaged, stop using it, and contact your local LEADER agent. Using a damaged power cord could lead to electrical shock or fire.

When removing the power cord from the power outlet, do not pull on the cord. Pull from the plug.

## ■ Warnings Concerning Grounding

The instrument has a ground terminal to protect the user and the instrument from electric shock. Ensure that the product is properly grounded for safe operation.

## ■ Warnings Concerning the Panel

Sections of the panel are made out of glass. If the glass breaks, the broken glass may lead to injury. Do not apply a strong shock to the panel, cut it with sharp metal, or damage it in any similar manner.

# GENERAL SAFETY SUMMARY



- Cautions Concerning the Input and Output Connectors

To avoid damaging the instrument, only apply signals to the input connectors that conform to the specifications in this instruction manual. Do not short or apply external voltage to the output connectors.

Doing so could damage the instrument.

- If You Will Not Use the Instrument for an Extended Period of Time

If you will not use the instrument for an extended period of time, remove the power plug from the outlet.

- Cautions Concerning the Ethernet Port

When you are connecting the instrument to the communication provider's equipment, connect to the Ethernet port through a hub that is authorized for use in the country that you are using the instrument in.

# GENERAL SAFETY SUMMARY

## ■ Calibration and Repairs

This instrument has been carefully examined at the factory to ensure that its performance is in accordance with the standards. However, because of factors such as parts wearing out over time, the performance of the instrument may degrade. To ensure stable performance, we recommend that you have the instrument calibrated regularly. Also, if the instrument malfunctions, repairs are necessary. For repairs and calibration, contact your local LEADER agent.

## ■ Routine Maintenance

When you clean the instrument, remove the power plug from the outlet.

Do not use thinner or benzene when you clean the instrument's case, panels, or knobs. Doing so could lead to paint chipping and the corrosion of plastic components. To clean the case, panels, and knobs, use a soft cloth with mild detergent, and wipe gently. While cleaning, make sure that foreign materials, such as water and detergent, do not enter the product. If liquid or a metal object enters into the instrument, fire or electric shock may result.

## ■ About the European WEEE Directive

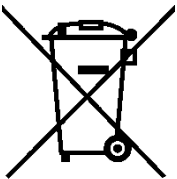

This instrument and its accessories are subject to the European WEEE Directive. Follow the applicable regulations of your country or region when discarding this instrument or its accessories. Follow the EU Battery Directive when discarding the batteries that you removed from this instrument.



(WEEE stands for Waste Electrical and Electronic Equipment.)

---

---

Follow the warnings and precautions that have been listed in this section to use the instrument correctly and safely. Precautions are also contained in various other sections of this instruction manual. To use the instrument correctly, be sure to follow those precautions as well.

If you have any questions or comments about this instruction manual, please contact your local LEADER agent.

---

---

## 1. INTRODUCTION

Thank you for purchasing this LEADER instrument. To use this instrument safely, read this instruction manual thoroughly, and make sure that you know how to use the instrument properly.

If some point about the operation of this instrument is still unclear after you have read this instruction manual, refer to the contact information on the back cover of the manual to contact LEADER, or contact your local LEADER agent.

After you have finished reading this manual, keep it in a convenient place so that you can refer to it when necessary.

### 1.1 Scope of Warranty

This LEADER instrument has been manufactured under the strictest quality control guidelines.

LEADER shall not be obligated to furnish the following free services during the warranty period.

1. Repair of malfunction or damages resulting from fire, natural calamity, or improper voltage applied by the user.
2. Repair of a product that has been improperly repaired, adjusted, or modified by personnel other than a factory-trained LEADER representative.
3. Repair of malfunctions or damages resulting from improper use.
4. Repair of malfunctions caused by devices other than this instrument.
5. Repair of malfunctions or damages without the presentation of a proof of purchase or receipt bill for the instrument.

### 1.2 Trademarks

The company and product names in this document are trademarks or registered trademarks of their respective holders.

## 1. INTRODUCTION

### 1.3 Operating Precautions

#### 1.3.1 Power Supply Voltage



Confirm the voltage of the power source before you connect the power cord to it. The power requirements and fuse rating of this product are indicated on the rear panel. Only use a power source that supplies a voltage within the operating voltage range and has a frequency of 50/60 Hz.

#### 1.3.2 Maximum Allowable Input Voltage



The maximum signal voltage that can be applied to the input connectors is indicated below. Do not apply excessive voltage to the connectors. Doing so may damage the device or lead to injury.

Input Connector	Maximum Allowable Voltage
GENLOCK IN	$\pm 5$ V (DC + peak AC)
GPS IN (SER01)	3.3 Vp-p
GNSS IN (SER04)	3.3Vp-p
CW IN/OUT (SER01/SER04)	2 Vp-p
LTC IN/OUT (SER01/SER04)	4 Vp-p

#### 1.3.3 Mechanical Shock

This instrument contains sensitive components, so it may be damaged if it is dropped or otherwise exposed to a strong shock.

#### 1.3.4 Electrostatic Damage

Electronic components can be damaged by static discharge. Static electricity can build up in the core wire of a coaxial cable. Before connecting a coaxial cable to an I/O connector of the instrument, short the core wire of the cable with the external conductor.

#### 1.3.5 Warming Up

To ensure more accurate measurements, turn ON the instrument approximately 30 minutes before you intend to use it to allow its internal temperature to stabilize.

## 1.4 Terminology Used in This Manual

- When using the LT 4611

If you are using the LT 4611, replace the LT 4610 with the LT 4611 and read unless otherwise stated.

- SER\*\*

LT 4610SER\*\* and LT 4611SER\*\* are referred to as SER\*\*.

- Underlining ( \_ )

Underlined options indicate the default values.

- Logo App

Logo App refers to a software application for converting bitmap data (\*.bmp) into 4-level monochrome data (\*.lg) that can be used on the LT 4610 and LT 4611. It is included in the CD-ROM.

- Input Format

The following names are used for the SDI signal input formats.

Name	Description
SD	SD-SDI
HD	HD-SDI
HD(DL)	HD-SDI dual link
3G-A	3G-SDI level A
3G-B	3G-SDI level B
3G	Collective name for 3G-A and 3G-B
12G	12G-SDI
4K(SQD)	4K square division
4K(2SI)	4K 2-sample interleave

## 2. PRODUCT CONFIGURATION

### 2.1 Main Unit

LT 4610 SYNC GENERATOR	GENLOCK function, 6 analog sync signal outputs, WCLK output, 2 SDI signal outputs, and AES/EBU audio outputs are standard features.
LT4611 SYNC GENERATOR	GENLOCK function, 3 analog sync signal outputs, WCLK output are standard features. 3 additional analog sync signal outputs, 2 SDI signal outputs, and AES/EBU audio outputs are software options.

### 2.2 Hardware Options

The following hardware options are common to the LT 4610 and LT 4611.

To replace or add hardware options, contact your local LEADER agent. You cannot install or uninstall units.

Table 2-1 Hardware options

Model name	Model number		Main functions
	LT 4610	LT 4611	
GPS/TC	LT 4610SER01		GPS synchronization, 10 MHz CW I/O, LTC I/O (*1)
12G-SDI	LT 4610SER02		12G-SDI (4K) pattern output Natural picture support with 3G-SDI quad link
PTP	LT 4610SER03		PTP grand master, slave function
GPS/BDS	LT 4610SER04		GPS / BDS synchronization, 10 MHz CW I/O, LTC I/O (*1)

\*1 The LT 4610SER01 and LT 4610SER04 cannot be installed in the instrument at the same time.

### 2.3 Software Options

The following software options (sold separately) can be installed in the LT 4610.

If you want to obtain a software option, provide your local LEADER agent with the LT 4611's MAC address (see the LICENSE tab) and serial number (see the rear panel). We will issue a license key.

When you receive the license key, install the option by referring to 21.13.2, "Installing Software Options." Each LT 4610 requires a unique license key. You cannot use the same key for multiple instruments.

Table 2-2 Software options

Model name	Model number		Main functions
	LT 4610	LT 4611	
SYNC 3 OUT ADD	Standard feature	LT 4611SER21	3 additional analog sync signal output connectors with independent phase adjustment function
SDI OUTPUT	Standard feature	LT 4611SER22	2 SD-SDI, HD-SDI, 3G-SDI output connectors
AUDIO OUTPUT	Standard feature	LT 4611SER23	2 AES/EBU output connectors
8K	LT 4610SER24	LT 4611SER24	8K SDI pattern output (*1)

\*1 You need the LT 4610SER02 to install the LT 4610SER24 in the LT 4610.  
You need the LT 4610SER02 to install the LT 4611SER24 in the LT 4611.  
The 8K patterns are output from the 12G-SDI output connectors.

### 3. GENERAL

This product is a 1U full-rack size sync signal generator that outputs analog video sync signals and audio word-clock signals from broadcast stations. The external sync signal genlock function allows synchronized operation with input signals.

The genlock function has a stay-in-sync function that maintains the phase when an error occurs in the input analog video sync signal. The dual power supply unit provides redundant operation. These features make it possible to configure a highly reliable system.

Further, numerous options are available to allow GPS synchronization and PTP synchronization as well as arbitrary pattern output and digital audio output using 12G-SDI, 3G-SDI, HD-SDI, and SD-SDI. These options are designed to enable the management of the optimal synchronization system for your application.



## 4. FEATURES

### 4.1 LT 4610 Main Unit

- Genlock Function

Various output signals can be synchronized by applying NTSC/PAL black burst signals, which are analog video sync signals, and HDTV tri-level sync signals.

NTSC/PAL black burst signal with field reference pulse and NTSC black burst signal with 10 field IDs are also supported.

- Stay-in-Sync and Slow Lock Functions

A Stay-in-Sync function is available in case errors occur at the genlock input. In addition, a slow lock function is available to reduce the shock that occurs when genlock is performed again based on stay-in-sync. This makes it possible to construct an extremely reliable synchronization system.

- Analog Video Sync Signal Output

Six analog video sync signals can be output. The phase of each output can be adjusted independently.

NTSC/PAL black burst signal with field reference pulse and NTSC black burst signal with 10 field IDs are also supported.

- Word-Clock Signal Output

The LT 4610 can output a 48 kHz word-clock signal synchronized with video signals.

- Real Time Clock

The real time clock is backed up by a battery. There is no need to reset the clock even when the power is turned off and on.

- Ethernet

SNMP is supported. When an error is detected, a TRAP is issued. Further, the LT 4610 can be controlled through HTTP.

- Preset Memory Function

Up to 10 presets can be saved. Convenient registered presets can be recalled during operation. The LT 4610 can be started with the same settings every time.

- External Memory Support

Logo data and preset data can be written and saved from the front panel using USB memory devices.

- Redundant Power Supply

Two power supplies are built in to provide redundancy. When errors occur in power supply units, alarms are indicated on the LT 4610 panel. Errors can also be output as alarms using SNMP.

## 4. FEATURES

- Triple-rate SDI Ready

SDI signal output supports 3G-SDI (level A and level B), HD-SDI (including dual link), and SD-SDI. There are two independent outputs of SDI signal output terminals. The pattern and phase can be set separately for each. (However, only a single output is available for 3G-SDI level B and HD dual link.)

- ID Character Overlay

ID characters can be overlaid at any position on the display. In addition, ID characters can be scrolled horizontally and displayed in a blinking state for checking whether the display has frozen.

- Logo Mark Overlay

A logo mark that is 320 (dot) × 240 (line) in size (QVGA size) can be overlaid at any position on the display. Logo marks are 4-level monochrome data converted from bitmap data.

- Safety Area Markers

90% and 80% safety area markers can be overlaid on the display. For 3G-SDI and HD-SDI, a 4:3 aspect marker can be overlaid.

- Pattern Scrolling

Equipped with a function for scrolling patterns in eight directions. The speed can also be adjusted.

- Audio Embedding

The LT 4610 can embed 32 channels (stream 1 (\*1), stream 2 (\*1), 4 channels each × 4 groups) of audio signals for 3G-SDI level B and 16 channels (4 channels × 4 groups) of audio signals for 3G-SDI level A, HD-SDI, and SD-HDI. The frequency, level, and the like can be set for each channel.

- Lip Sync Patterns

The LT 4610 can output lip sync patterns in which the video and audio are synchronized. In combination with a waveform monitor that features a lip sync function, such as the Leader's LV 5770A, it is possible to accurately measure the offset between the video and audio in SDI signal transmissions.

- AES/EBU Signal Output

The LT 4610 can output a 48 kHz AES/EBU signal synchronized with video signals. It is also equipped with a muted AES/EBU signal output.

\*1 On the menu, stream 1 and stream 2 are displayed as LINK-A and LINK-B, respectively.

### 4.2 LT 4611 Main Unit

- Genlock Function

Various output signals can be synchronized by applying NTSC/PAL black burst signals, which are analog video sync signals, and HDTV tri-level sync signals.

NTSC/PAL black burst signal with field reference pulse and NTSC black burst signal with 10 field IDs are also supported.

- Stay-in-Sync and Slow Lock Functions

A Stay-in-Sync function is available in case errors occur at the genlock input. In addition, a slow lock function is available to reduce the shock that occurs when genlock is performed again based on stay-in-sync. This makes it possible to construct an extremely reliable synchronization system.

- Analog Video Sync Signal Output

Three analog video sync signals can be output (up to six using an option). The phase of each output can be adjusted independently.

NTSC/PAL black burst signal with field reference pulse and NTSC black burst signal with 10 field IDs are also supported.

- Word-Clock Signal Output

The LT 4611 can output a 48 kHz word-clock signal synchronized with video signals.

- Real Time Clock

The real time clock is backed up by a battery. There is no need to reset the clock even when the power is turned off and on.

- Ethernet

SNMP is supported. When an error is detected, a TRAP is issued. Further, the LT 4611 can be controlled through HTTP.

- Preset Memory Function

Up to 10 presets can be saved. Convenient registered presets can be recalled during operation. The LT 4611 can be started with the same settings every time.

- External Memory Support

Logo data and preset data can be written and saved from the front panel using USB memory devices.

- Redundant Power Supply

Two power supplies are built in to provide redundancy. When errors occur in power supply units, alarms are indicated on the LT 4611 panel. Errors can also be output as alarms using SNMP.

## 4. FEATURES

### 4.3 LT 4610SER01 (GPS/TC)

- GPS Synchronization

A GPS antenna can be connected to generate and output signals by locking to the frequency and clock obtained from the GPS.

- Time Code I/O

The time code generator can run in free run mode based on internal time information. It can also embed ATC (LTC) in SDI signal output or VITC in analog video sync signal output based on a GPS, LTC, or VITC time information.

It also features a holdover function, which retains the phase and frequency of the output signal when GPS signals or CW signals are lost. Further, when GPS lock is in effect, the LT 4610 can also be used as an NTP server.

- CW I/O

The CW I/O connector not only receives 10 MHz CW but also outputs 10 MHz CW or 1PPS, whichever is selected.

- LTC I/O

The LTC I/O connector receives LTC1, outputs LTC 3, and outputs two separate alarms.

## 4. FEATURES

### 4.4 LT 4610SER02 (12G-SDI)

- 12G-SDI (4K) Support

Four output connectors supporting 12G-SDI, 3G-SDI (level A, level B), HD-SDI (including dual link), and SD-SDI are available to accommodate the 4K video format. The format is the same for all four outputs, but you can set different patterns and phases for each. Only two outputs are available for 3G-SDI level B and HD dual link.

- User Pattern Generation

In addition to internal patterns such as the color bar, SD, HD (2K), and 4K user patterns can be output.

- ID Character Overlay

ID characters can be overlaid at any position on the display. In addition, ID characters can be scrolled horizontally or displayed in a blinking state for checking whether the display has frozen.

- Safety Area Markers

90% and 80% safety area markers can be overlaid on the display. For 12G-SDI, 3G-SDI and HD-SDI, a 4:3 aspect marker can be overlaid.

- Pattern Scrolling

This option is equipped with a function for scrolling patterns in eight directions. The moving speed can be varied.

- Moving Box

A moving box can be overlaid on the display. Its color, size, and moving speed can be varied.

- Audio Embedding

This option can embed 32 channels (stream 1 (\*1), stream 2 (\*1), 4 channels each × 4 groups) of audio signals for 3G-SDI level B and 16 channels (4 channels × 4 groups) of audio signals for 3G-SDI level A, HD-SDI, and SD-HDI. The frequency, level, and the like can be set for each channel.

- Lip Sync Patterns

This option can output lip sync patterns in which the video and audio are synchronized. In combination with a waveform monitor that features a lip sync function, such as the Leader's LV 5770A, it is possible to measure the offset between the video and audio in SDI signal transmissions.

\*1 On the menu, stream 1 and stream 2 are displayed as LINK-A and LINK-B, respectively.

## 4. FEATURES

### 4.5 LT 4610SER03 (PTP)

- PTP Grand Master Function

This option supports the Precision Time Protocol defined in IEEE1588-2008 and operates as a PTP grand master. SMPTE ST 2059, AES67, and General profiles are supported. The PTP time source is obtained from the internal clock or GPS.

- PTP Slave Function

When a host PTP grand master is present in the system, this option operates as a PTP slave and can operate as a master to even lower devices.

- 10GbE Ready

In addition to the RJ-45 port, a 10GbE SFP+ module, sold separately, can be used.

### 4.6 LT 4610SER04 (GPS/BDS)

- GPS /BDS Synchronization

A GNSS antenna can be connected to generate and output signals by locking to the frequency and clock obtained from the GPS or BDS.

- Time Code I/O

The time code generator can run in free run mode based on internal time information. It can also embed ATC (LTC) in SDI signal output or VITC in analog video sync signal output based on a GPS, BDS, LTC, or VITC time information.

It also features a holdover function, which retains the phase and frequency of the output signal when GPS signals, BDS signals, or CW signals are lost. Further, you can use the instrument as an NTP server by using the time information from GPS and BDS.

- CW I/O

The CW I/O connector not only receives 10 MHz CW but also outputs 10 MHz CW or 1PPS, whichever is selected.

- LTC I/O

The LTC I/O connector receives LTC1, outputs LTC 3, and outputs two separate alarms.

## 4. FEATURES

### 4.7 LT 4610SER24 (8K)

The LT 4610SER24 is a software option for the LT 4610 that adds the ability to output the 8K patterns from the 12G-SDI connectors, when the LT 4610 is equipped with the hardware option LT 4610SER02.

- 12G-SDI 8K

QUAD LINK 12G-SDI 8K (7680 x 4320) can be output.

- User Pattern Output

User pattern can be output in addition to built-in patterns such as color bars.

- Safety Area Markers

90% and 80% safety area markers can be overlaid on the display. For 12G-SDI, a 4:3 aspect marker can be overlaid.

- Pattern Scrolling

Equipped with a function for scrolling patterns in eight directions. The moving speed can be varied.

- Moving Box

A moving box can be overlaid on the display. Its color, size, and moving speed can be varied.

- Audio Embedding

The LT 4610SER24 can embed 16 channels (4 channels × 4 groups) of audio signals for 12G-SDI. The frequency, level, and the like can be set for each channel.

- Lip Sync Patterns

The LT 4610SER24 can output lip sync patterns in which the video and audio are synchronized.

### 4.8 LT 4611SER21 (SYNC 3 OUT ADD)

Software option for the LT 4611 only. It is a standard feature on the LT 4610.

- Three Additional Analog Sync Signal Outputs

In addition to the three outputs on the standard LT 4611, three analog video sync signal outputs can be added. NTSC/PAL black burst signal with field reference pulse and NTSC black burst signal with 10 field IDs are also supported.

- Independent Phase Adjustment

The phases of all analog video sync signal outputs can be adjusted.

## 4. FEATURES

### 4.9 LT 4611SER22 (SDI OUTPUT)

Software option for the LT 4611 only. It is a standard feature on the LT 4610.

- Triple-rate SDI Ready

SDI signal output supports 3G-SDI (level A and level B), HD-SDI (including dual link), and SD-SDI. There are two independent outputs of SDI signal output terminals. The pattern and phase can be set separately for each. (However, only a single output is available for 3G-SDI level B and HD dual link.)

- ID Character Overlay

ID characters can be overlaid at any position on the display. In addition, ID characters can be scrolled horizontally and displayed in a blinking state for checking whether the display has frozen.

- Logo Mark Overlay

A logo mark that is 320 (dot) × 240 (line) in size (QVGA size) can be overlaid at any position on the display. Logo marks are 4-level monochrome data converted from bitmap data.

- Safety Area Markers

90% and 80% safety area markers can be overlaid on the display. For 3G-SDI and HD-SDI, a 4:3 aspect marker can be overlaid.

- Pattern Scrolling

This option is equipped with a function for scrolling patterns in eight directions. The moving speed can be varied.

- Audio Embedding

This option can embed 32 channels (stream 1 (\*1), stream 2 (\*1), 4 channels each × 4 groups) of audio signals for 3G-SDI level B and 16 channels (4 channels × 4 groups) of audio signals for 3G-SDI level A, HD-SDI, and SD-HDI. The frequency, level, and the like can be set for each channel.

- Lip Sync Patterns

This option can output lip sync patterns in which the video and audio are synchronized. In combination with a waveform monitor that features a lip sync function, such as the Leader's LV 5770A, it is possible to measure the offset between the video and audio in SDI signal transmissions.

\*1 On the menu, stream 1 and stream 2 are displayed as LINK-A and LINK-B, respectively.

### 4.10 LT 4611SER23 (AUDIO OUTPUT)

Software option for the LT 4611 only. It is a standard feature on the LT 4610.

- AES/EBU Signal Output

This option can output a 48 kHz AES/EBU signal synchronized with video signals. It is also equipped with a muted AES/EBU signal output.



## 4. FEATURES

### 4.11 LT 4611SER24 (8K)

The LT 4611SER24 is a software option for the LT 4611 that adds the ability to output the 8K patterns from the 12G-SDI connectors, when the LT 4611 is equipped with the hardware option LT 4610SER02.

- 12G-SDI 8K

QUAD LINK 12G-SDI 8K (7680 x 4320) can be output.

- User Pattern Output

User pattern can be output in addition to built-in patterns such as color bars.

- Safety Area Markers

90% and 80% safety area markers can be overlaid on the display. For 12G-SDI, a 4:3 aspect marker can be overlaid.

- Pattern Scrolling

Equipped with a function for scrolling patterns in eight directions. The moving speed can be varied.

- Moving Box

A moving box can be overlaid on the display. Its color, size, and moving speed can be varied.

- Audio Embedding

The LT 4611SER24 can embed 16 channels (4 channels × 4 groups) of audio signals for 12G-SDI. The frequency, level, and the like can be set for each channel.

- Lip Sync Patterns

The LT 4611SER24 can output lip sync patterns in which the video and audio are synchronized.

## 5. SPECIFICATIONS

### 5. SPECIFICATIONS

#### 5.1 LT 4610 Main Unit

##### 5.1.1 Compliant Standards

SDI Embedded Audio	
3G, HD, HD(DL)	SMPTE ST 299
SD	SMPTE ST 272
SDI Payload ID	SMPTE ST 352
Analog Video Sync Signal	
NTSC Black Burst Signal	SMPTE ST 170, SMPTE ST 318, SMPTE RP 154
PAL Black Burst Signal	ITU-R BT 1700, EBU N14
HD Tri-Level Sync Signal	SMPTE ST 240, SMPTE ST 274, SMPTE ST 296
AES/EBU	ANSI S4.40, AES3-2009, AES11-2009, SMPTE ST 276

##### 5.1.2 SDI Formats and Standards

###### HD, SD Video Signal Formats and Standards

Color System	Quantization	Image	Frame (Field) Frequency/Scanning	Compliant Standards
YCbCr 4:2:2	10 bit	1280×720	60/59.94/50/30/29.97/25/24/23.98/P	SMPTE ST 292-1 SMPTE ST 296
		1920×1080	60/59.94/50/I	SMPTE ST 292-1 SMPTE ST 274
			30/29.97/25/24/23.98/P	
			24/23.98/PsF	
		720×487	59.94/I	SMPTE ST 292-1 SMPTE RP 211
720×576	50/I	SMPTE ST 259		

###### HD(DL) Video Signal Formats and Standards

Color System	Quantization	Image	Frame (Field) Frequency/Scanning	Compliant Standards
YCbCr 4:2:2	10 bit	1920×1080	60/59.94/50/P	SMPTE ST 274 SMPTE ST 372
	12 bit	1920×1080	60/59.94/50/I	
			30/29.97/25/24/23.98/P 30/29.97/25/24/23.98/PsF	
YCbCr 4:4:4	10 bit	1920×1080	60/59.94/50/I	
	12 bit		30/29.97/25/24/23.98/P	
			30/29.97/25/24/23.98/PsF	
RGB 4:4:4	10 bit	1920×1080	60/59.94/50/I	
	12 bit		30/29.97/25/24/23.98/P	
			30/29.97/25/24/23.98/PsF	

## 5. SPECIFICATIONS

### 3G-A Video Signal Formats and Standards

Color System	Quantization	Image	Frame (Field) Frequency/Scanning	Compliant Standards	
Y <sub>C</sub> B <sub>R</sub> C <sub>R</sub> 4:2:2	10 bit	1920×1080	60/59.94/50/P	SMPTE ST 274 SMPTE ST 425	
	12 bit	1920×1080	60/59.94/50/I		
			30/29.97/25/24/23.98/P		
			30/29.97/25/24/23.98/PsF		
Y <sub>C</sub> B <sub>R</sub> C <sub>R</sub> 4:4:4	10 bit	1280×720	60/59.94/50/30/29.97/25/24/23.98/P	SMPTE ST 296 SMPTE ST 425	
		1920×1080	60/59.94/50/I		SMPTE ST 274 SMPTE ST 425
			30/29.97/25/24/23.98/P		
	12 bit	1920×1080	60/59.94/50/I	SMPTE ST 274 SMPTE ST 425	
			30/29.97/25/24/23.98/P		
			30/29.97/25/24/23.98/PsF		
RGB 4:4:4	10 bit	1280×720	60/59.94/50/30/29.97/25/24/23.98/P	SMPTE ST 296 SMPTE ST 425-1	
		1920×1080	60/59.94/50/I		SMPTE ST 274 SMPTE ST 425-1
			30/29.97/25/24/23.98/P		
	12 bit	1920×1080	60/59.94/50/I	SMPTE ST 274 SMPTE ST 425-1	
			30/29.97/25/24/23.98/P		
			30/29.97/25/24/23.98/PsF		

### 3G-B Video Signal Formats and Standards

Color System	Quantization	Image	Frame (Field) Frequency/Scanning	Compliant Standards
Y <sub>C</sub> B <sub>R</sub> C <sub>R</sub> 4:2:2	10 bit	1920×1080	60/59.94/50/P	SMPTE ST 274 SMPTE ST 372 SMPTE ST 425-1
	12 bit	1920×1080	60/59.94/50/I	
			30/29.97/25/24/23.98/P	
			30/29.97/25/24/23.98/PsF	
Y <sub>C</sub> B <sub>R</sub> C <sub>R</sub> 4:4:4	10 bit	1920×1080	60/59.94/50/I	SMPTE ST 274 SMPTE ST 372 SMPTE ST 425-1
			30/29.97/25/24/23.98/P	
			30/29.97/25/24/23.98/PsF	
	12 bit	1920×1080	60/59.94/50/I	
30/29.97/25/24/23.98/P				
RGB 4:4:4	10 bit	1920×1080	60/59.94/50/I	SMPTE ST 274 SMPTE ST 372 SMPTE ST 425-1
			30/29.97/25/24/23.98/P	
			30/29.97/25/24/23.98/PsF	
	12 bit	1920×1080	60/59.94/50/I	
30/29.97/25/24/23.98/P				

## 5. SPECIFICATIONS

### 5.1.3 I/O Connectors

#### SDI Output Connector

Connector	2 BNC connectors
3G-A, HD, SD	2
3G-B, HD(DL)	1
Output Impedance	75 $\Omega$
Output Amplitude	800 mVp-p $\pm$ 10%
Output Return Loss	
5 MHz to 1.485 GHz	15 dB or more
1.485 to 2.97 GHz	10 dB or more
Overshoot	Less than 10%
Rise and Fall Times	
3G	$\leq$ 135 ps (20 to 80%)
HD, HD(DL)	$\leq$ 270 ps (20 to 80%)
SD	0.4 ns to 1.5 ns (20 to 80%)
DC Offset	0 $\pm$ 0.5 V

#### Genlock Input Connector

Connector	2 BNC connectors
Input Signal	Analog composite sync signal Analog component sync signal
Format	Loop-through
Input Impedance	15 k $\Omega$
Maximum Input Voltage	$\pm$ 5 V (DC + peak AC)
Operating Input Level Range	$\pm$ 6 dB
External Lock Range	$\pm$ 5 ppm
Jitter	1 ns (when genlock is in use)

#### Analog Video Sync Signal Output Connector

Connector	6 BNC connectors, 6 outputs
Output Signal	NTSC black burst signal PAL black burst signal HD tri-level sync signal
Output Impedance	75 $\Omega$
Sync Level	
NTSC	40 $\pm$ 1 IRE
PAL	-300 $\pm$ 6 mV
HD	$\pm$ 300 $\pm$ 6 mV
Blanking	0 $\pm$ 15 mV

#### AES/EBU Digital Audio Output Connector

Connector	1 BNC connector
Output Amplitude	1 Vp-p $\pm$ 0.1 V
Output Impedance	75 $\Omega$ unbalanced

#### AES/EBU Silence Output Connector

Connector	1 BNC connector
Output Amplitude	1 Vp-p $\pm$ 0.1 V
Output Impedance	75 $\Omega$ unbalanced

## 5. SPECIFICATIONS

### Word-Clock Output Connector

Connector	1 BNC connector
Output Frequency	48 kHz
Output Amplitude	3.5 V or more (high level not terminated with 75 $\Omega$ ) 2.4 V or more (high level terminated with 75 $\Omega$ )

### 5.1.4 Control Connectors

#### Ethernet Port

Specifications	IEEE 802.3
Protocol	
SNMP v2c	Command operation and trap transmission Transmission of operation status (e.g., genlock synchronization status)
HTTP	Remote monitoring and control from a Web browser
Connector	RJ-45
Type	10BASE-T/100BASE-TX auto switching

#### USB Port

Specifications	USB 2.0
Supported Media	USB memory device
Function	Saving and recalling presets, genlock log, logo, and ID characters Updating firmware Retrieving MIB files
Connector	USB Type A

### 5.1.5 LCD

Number of Characters	20 characters $\times$ 2 lines
Backlight	On / Off

## 5. SPECIFICATIONS

### 5.1.6 SDI Video Output

#### SDI Signal

##### Bit Rate

3G	2.970Gbps, 2.970/1.001Gbps
HD, HD(DL)	1.485Gbps, 1.485/1.001Gbps
SD	270 Mbps

#### Timing Adjustment

##### Adjustment Range

Entire frame

##### Adjustment Unit

V

Lines

H

Clocks (148.5 MHz, 148.5/1.001 MHz,  
74.25 MHz, 74.25/1.001 MHz, 27 MHz)

#### Test Patterns

##### 3G, HD

100% color bar, 75% color bar,  
multiformat color bar (ARIB STD-B28, pattern 2  
area can be set to 100% white, 75% white, or +I),  
check field,  
flat field white 100%, black 0%, red 100%,  
green 100%, blue 100%

##### SD

##### 525/59.94I

100% color bar, 75% color bar,  
SMPTE color bar, check field,  
flat field white 100%, black 0%, red 100%,  
green 100%, blue 100%

##### 625/50I

100% color bar, EBU color bar,  
BBC color bar, check field,  
flat field white 100%, black 0%, red 100%,  
green 100%, blue 100%

#### Automatic Switching

Automatically switches between selectable color bar  
patterns

##### Switch Time

1 to 255 sec

#### Pattern Scrolling

##### Direction

Eight directions (up, down, left, right, and their  
combinations)

#### Speed Range and Unit

##### Interlace

In unit of fields

V

0 to 256 lines, in 1 line steps

H

0 to 256 dots, in 2 dot steps

##### Progressive

In unit of frames

V

0 to 256 lines, in 1 line steps

H

0 to 256 dots, in 2 dot steps

\* Not available when the check field pattern is selected.

## 5. SPECIFICATIONS

### Safety Area Markers

3G, HD	Action safe area (90%) Title safe area (80%) 4:3 aspect ratio (can be turned on and off separately)
SD	Action safe area (90%) Title safe area (80%) (can be turned on and off separately)

\* Not available when the check field pattern is selected.

### ID Characters

Number of Characters	Up to 20 characters
Size [Dots]	32×32 / 64×64 / 128×128 / 256×256
Intensity	100%, 75% (black only for the background color)
Display Position	Anywhere on the display
Display Position Adjustment Resolution	
V	1 line
H	1 dot
Blinking Display (*1)	ON / OFF
ON TIME	1 to 9 sec, in 1 sec step
OFF TIME	1 to 9 sec, in 1 sec step
Scrolling (*1)	
Function	Scroll including the ID character background
Direction	Two directions (left and right)
Speed Range and Unit	
Interlace	In unit of fields 0 to 256 dots, in 2 dot steps
Progressive	In unit of frames 0 to 256 dots, in 2 dot steps

\* Not available when the check field pattern is selected.

\*1 The blinking display and scrolling can be used simultaneously.

## 5. SPECIFICATIONS

### Logo Mark

Logo Mark Data	4-level monochrome data from level 0 to 3
Maximum Size	320 (dots) × 240 (lines) (QVGA size)
Number of Logo Marks That Can Be Saved in the LT 4610	Up to 4
Display Position	Anywhere on the display
Display Position Adjustment Resolution	
V	1 line
H	1 dot
Display Level	Any level from 0 to 3
File Format	
Before Conversion	24-bit full color bitmap format (.bmp)
After Conversion	Original format (.lg)
Conversion Color Matrix	$Y = (0.212 \times R) + (0.701 \times G) + (0.087 \times B)$ Converts 256-level monochrome data (Y) to 4 levels (levels 0 to 3) using specified thresholds
Conversion Method	Using the logo application
Logo Mark Data Transfer	Save the data to a USB memory device and transfer to the LT 4610.

\* Not available when the check field pattern is selected.

### Component On/Off

Function	Each of the Y/G, Cb/B, and Cr/R components can be turned on and off independently.
----------	--

\* Not available when the check field pattern is selected.

### Image Overlay

Display Precedence	ID characters > logo mark > safety area markers > test pattern (The display order cannot be changed.)
Simultaneous Display	ID characters, logo mark, safety area markers, and test pattern can be displayed simultaneously.



## 5. SPECIFICATIONS

### Embedded Audio

Embedded Channels	Can be turned on and off at the group level
3G-A, HD, SD	16 channels (4 channels × 4 groups)
3G-B	32 channels (stream 1, stream 2, 4 channels each × 4 groups)
Sampling Frequency	48 kHz sampling (synced with the video signal)
Resolution	20 bits, 24 bits
Pre-emphasis	OFF, 50/15, CCITT (only the CS bit is switched)
Frequency	SILENCE / 400Hz / 800Hz / 1kHz
Level	-60 to 0 dBFS (1 dBFS steps)
Audio Click	OFF, 1 / 2 / 4 sec

- \* Audio (including packets) cannot be embedded when the check field pattern is selected.
- \* The frequency, level, and audio click can be set for each channel.
- \* The following limitations apply for SD (525/59.94I).
  - For 16 channel output, the resolution is set to 20 bits.
  - Up to three groups (12 channels) can be output at 24-bit resolution.

### 5.1.7 Genlock Function

Signal Formats	NTSC BB, NTSC BB+REF, NTSC BB+ID, NTSC BB+REF+ID, PAL BB, PAL BB+REF, 525/59.94I, 525/59.94P, 625/50I, 625/50P, 1125/60I, 1125/59.94I, 1125/50I, 1125/30P, 1125/29.97P, 1125/25P, 1125/24P, 1125/23.98P, 1125/24PsF, 1125/23.98PsF, 750/60P, 750/59.94P, 750/50P, 750/30P, 750/29.97P, 750/25P, 750/24P, 750/23.98P
Timing Adjustment	
Adjustment Range	
NTSC Black Burst Signal	±5 frames
PAL Black Burst Signal	±2 frames
HD Tri-Level Sync Signal	1 frame (entire frame)
FINE	Covers 1 adjustment unit (adjustment unit: 13.5 MHz, clock width: 74.1 nsec)
Genlock Mode	
INTERNAL	Operates using the internal reference signal
EXTERNAL	Operates using an external reference signal GL FMT-AUTO / GL FMT-MANUAL / GPS(SER01) / GNSS(SER04) / 10MHz CW(SER01/SER04) / PTP(SER03)
Recovery Mode	
AUTO	Resynchronizes according to the auto setting when the external reference signal recovers
MANUAL	Retains the STAY IN SYNC state when the external reference signal recovers

## 5. SPECIFICATIONS

Auto Setting	
IMMEDIATE	Resets the lock when the external reference signal recovers
FAST	Quickly resynchronizes when the external reference signal recovers
SLOW	Slowly resynchronizes when the external reference signal recovers
Manual Setting	
IMMEDIATE	Resets the lock when the external reference signal recovers
FAST	Quickly resynchronizes when the external reference signal recovers
SLOW	Slowly resynchronizes when the external reference signal recovers
Genlock Reset	Resynchronizes immediately.

### 5.1.8 Analog Video Sync Signal Output

Signal Formats	Each of the 6 outputs can be set separately. NTSC BB, NTSC BB+REF, NTSC BB+ID, NTSC BB+REF+ID, NTSC BB+SETUP, NTSC BB+S+REF, NTSC BB+S+ID, NTSC BB+S+R+ID, PAL BB, PAL BB+REF, 525/59.94I, 525/59.94P, 625/50I, 625/50P, 1125/60I, 1125/59.94I, 1125/50I, 1125/30P, 1125/29.97P, 1125/25P, 1125/24P, 1125/23.98P, 1125/24PsF, 1125/23.98PsF, 750/60P, 750/59.94P, 750/50P, 750/30P, 750/29.97P, 750/25P, 750/24P, 750/23.98P
Timing Adjustment	Can be set separately for each of the 6 outputs
Adjustment Range	
NTSC Black Burst Signal	±5 frames
PAL Black Burst Signal	±2 frames
HD Tri-Level Sync Signal	1 frame (entire frame)
Adjustment Unit	
NTSC/PAL Black Burst Signal	In units of 0.0185 μs (54 MHz clock unit)
HD Tri-Level Sync Signal	In units of 0.0135 μs (74.25/1.001 MHz clock unit or 74.25 MHz clock unit)

## 5. SPECIFICATIONS

### 5.1.9 AES/EBU Digital Audio Output

Timing Adjustment	
Adjustment Range	±1 AES/EBU frame
Adjustment Unit	512 fs (24.576 MHz)
Sampling Frequency	48 kHz sampling (syncd with the video signal)
Resolution	20 bits, 24 bits
Pre-emphasis	OFF, 50/15, CCITT (only the CS bit is switched)
Frequency	SILENCE / 400Hz / 800Hz / 1kHz
Level	-60 to 0 dBFS (1 dBFS steps)
Audio Click	OFF, 1 / 2 / 4 sec
Lip Sync	Synchronization with SDI1
Sampling Clock Accuracy	Grade 2 (±10 ppm)

\* The frequency, level, and audio click can be set for each channel.

\* Turn off all channels to output a digital audio reference signal (DARS).

### 5.1.10 AES/EBU Silence Output

Timing Adjustment	
Adjustment Range	±1 AES/EBU frame
Adjustment Unit	512 fs (24.576 MHz)
Sampling Frequency	48 kHz sampling (syncd with the video signal)
Resolution	20 bits / 24 bits
Pre-emphasis	OFF
Frequency	SILENCE
Level	MUTE
Sampling Clock Accuracy	Grade 2 (±10 ppm)

### 5.1.11 Word-Clock Output

Timing Adjustment	
Adjustment Range	±1 AES/EBU frame
Adjustment Unit	512 fs (24.576 MHz)

### 5.1.12 Lip Sync Patterns

Setting SDI1+AES/EBU and SDI2 can be set separately.

\* Not available when the check field pattern is selected.

\* Safety area markers, ID characters, and logo mark cannot be overlaid.

\* The audio click setting of embedded audio is disabled, and audio synchronized to the lip sync pattern is output.

## 5. SPECIFICATIONS

### 5.1.13 Preset Settings

Preset	Saves the panel settings (*1)
Number of Presets	10
Recall Method	Front panel
Copy Method	Copy from the LT 4610 to a USB memory device or copy from the USB memory device to the LT 4610

\*1 Logo data and device-specific information (e.g., IP address, time) cannot be saved.

### 5.1.14 Logging Feature

Saved Items	Genlock status change, power failure, and fan stop
Copy Method	Copy from the LT 4610 to a USB memory device

### 5.1.15 Internal Reference Generator

Reference Frequency	13.5 MHz
---------------------	----------

### 5.1.16 Internal Clock

Power Supply	Primary lithium battery
Battery Operation Period	Approx. 3 years (depending on the storage and operating environments)

### 5.1.17 General Specifications

Environmental Conditions	
Operating Temperature	0 to 40 °C
Operating Humidity Range	85 %RH or less (no condensation)
Optimal Temperature	10 to 35 °C
Operating Environment	Indoors
Elevation	Up to 2,000 m
Overvoltage Category	II
Pollution Degree	2
Power Requirements	
Voltage	90 to 250 VAC
Power Consumption	80 W max.
Dimensions	482 (W) × 44 (H) × 400 (D) mm (excluding protrusions)
Weight	3.6 kg (excluding SER01, SER02, SER03, and SER04) 3.8 kg (including SER01 or SER04, SER02, and SER03)
Accessories	Power cord..... 2 Cover/Inlet stopper ..... 2 CD-ROM (Logo App, instruction manual)..... 1

## 5. SPECIFICATIONS

### 5.2 LT 4611 Main Unit

#### 5.2.1 Compliant Standards

##### Analog Video Sync Signal

NTSC Black Burst Signal	SMPTE ST 170, SMPTE ST 318, SMPTE RP 154
PAL Black Burst Signal	ITU-R BT 1700, EBU N14
HD Tri-Level Sync Signal	SMPTE ST 240, SMPTE ST 274, SMPTE ST 296

#### 5.2.2 I/O Connectors

##### Genlock Input Connector

Connector	2 BNC connectors
Input Signal	Analog composite sync signal Analog component sync signal
Format	Loop-through
Input Impedance	15 k $\Omega$
Maximum Input Voltage	$\pm 5$ V (DC + peak AC)
Operating Input Level Range	$\pm 6$ dB
External Lock Range	$\pm 5$ ppm
Jitter	1 ns (when genlock is in use)

##### Analog Video Sync Signal Output Connector

Connector	3 BNC connectors, 3 outputs
Output Signal	NTSC black burst signal PAL black burst signal HD tri-level sync signal
Output Impedance	75 $\Omega$
Sync Level	
NTSC	40 $\pm$ 1 IRE
PAL	-300 $\pm$ 6 mV
HD	$\pm$ 300 $\pm$ 6 mV
Blanking	0 $\pm$ 15 mV

##### Word-Clock Output Connector

Connector	1 BNC connector
Output Frequency	48 kHz
Output Amplitude	3.5 V or more (high level not terminated with 75 $\Omega$ ) 2.4 V or more (high level terminated with 75 $\Omega$ )

## 5. SPECIFICATIONS

### 5.2.3 Control Connectors

#### Ethernet Port

Specifications

IEEE 802.3

Protocol

SNMP v2c

Command operation and trap transmission

Transmission of operation status (e.g., genlock synchronization status)

HTTP

Remote monitoring and control from a Web browser

Connector

RJ-45

Type

10BASE-T/100BASE-TX auto switching

#### USB Port

Specifications

USB 2.0

Supported Media

USB memory device

Function

Saving and recalling presets, genlock log, logo, and ID characters

Updating firmware

Retrieving MIB files

Connector

USB Type A

### 5.2.4 LCD

Number of Characters

20 characters × 2 lines

Backlight

On / Off

## 5. SPECIFICATIONS

### 5.2.5 Genlock Function

Signal Formats	NTSC BB, NTSC BB+REF, NTSC BB+ID, NTSC BB+REF+ID, PAL BB, PAL BB+REF, 525/59.94I, 525/59.94P, 625/50I, 625/50P, 1125/60I, 1125/59.94I, 1125/50I, 1125/30P, 1125/29.97P, 1125/25P, 1125/24P, 1125/23.98P, 1125/24PsF, 1125/23.98PsF, 750/60P, 750/59.94P, 750/50P, 750/30P, 750/29.97P, 750/25P, 750/24P, 750/23.98P
Timing Adjustment	
Adjustment Range	
NTSC Black Burst Signal	±5 frames
PAL Black Burst Signal	±2 frames
HD Tri-Level Sync Signal	1 frame (entire frame)
FINE	Covers 1 adjustment unit (adjustment unit: 13.5 MHz, clock width: 74.1 nsec)
Genlock Mode	
INTERNAL	Operates using the internal reference signal
EXTERNAL	Operates using an external reference signal GL FMT-AUTO / GL FMT-MANUAL / GPS(SER01) / GNSS(SER04) / 10MHz CW(SER01/SER04) / PTP(SER03)
Recovery Mode	
AUTO	Resynchronizes according to the auto setting when the external reference signal recovers
MANUAL	Retains the STAY IN SYNC state when the external reference signal recovers
Auto Setting	
IMMEDIATE	Resets the lock when the external reference signal recovers
FAST	Quickly resynchronizes when the external reference signal recovers
SLOW	Slowly resynchronizes when the external reference signal recovers
Manual Setting	
IMMEDIATE	Resets the lock when the external reference signal recovers
FAST	Quickly resynchronizes when the external reference signal recovers
SLOW	Slowly resynchronizes when the external reference signal recovers
Genlock Reset	Resynchronizes immediately.

## 5. SPECIFICATIONS

### 5.2.6 Analog Video Sync Signal Output

Signal Formats	Each of the 3 outputs can be set separately. NTSC BB, NTSC BB+REF, NTSC BB+ID, NTSC BB+REF+ID, NTSC BB+SETUP, NTSC BB+S+REF, NTSC BB+S+ID, NTSC BB+S+R+ID, PAL BB, PAL BB+REF, 525/59.94I, 525/59.94P, 625/50I, 625/50P, 1125/60I, 1125/59.94I, 1125/50I, 1125/30P, 1125/29.97P, 1125/25P, 1125/24P, 1125/23.98P, 1125/24PsF, 1125/23.98PsF, 750/60P, 750/59.94P, 750/50P, 750/30P, 750/29.97P, 750/25P, 750/24P, 750/23.98P
Timing Adjustment	Can be set separately for each of the 3 outputs
Adjustment Range	
NTSC Black Burst Signal	±5 frames
PAL Black Burst Signal	±2 frames
HD Tri-Level Sync Signal	1 frame (entire frame)
Adjustment Unit	
NTSC/PAL Black Burst Signal	In units of 0.0185 μs (54 MHz clock unit)
HD Tri-Level Sync Signal	In units of 0.0135 μs (74.25/1.001 MHz clock unit or 74.25 MHz clock unit)

### 5.2.7 Word-Clock Output

Timing Adjustment	
Adjustment Range	±1 AES/EBU frame
Adjustment Unit	512 fs (24.576 MHz)

### 5.2.8 Preset Settings

Preset	Saves the panel settings (*1)
Number of Presets	10
Recall Method	Front panel
Copy Method	Copy from the LT 4611 to a USB memory device or copy from the USB memory device to the LT 4611

\*1 Logo data and device-specific information (e.g., IP address, time) cannot be saved.

### 5.2.9 Logging Feature

Saved Items	Genlock status change, power failure, and fan stop
Copy Method	Copy from the LT 4611 to a USB memory device

### 5.2.10 Internal Reference Generator

Reference Frequency	13.5 MHz
---------------------	----------



## 5. SPECIFICATIONS

### 5.2.11 Internal Clock

Power Supply	Primary lithium battery
Battery Operation Period	Approx. 3 years (depending on the storage and operating environments)

### 5.2.12 General Specifications

#### Environmental Conditions

Operating Temperature	0 to 40 °C
Operating Humidity Range	85 %RH or less (no condensation)
Optimal Temperature	10 to 35 °C
Operating Environment	Indoors
Elevation	Up to 2,000 m
Overvoltage Category	II
Pollution Degree	2

#### Power Requirements

Voltage	90 to 250 VAC
Power Consumption	80 W max.

#### Dimensions

482 (W) × 44 (H) × 400 (D) mm (excluding protrusions)

#### Weight

3.6 kg (excluding SER01, SER02, SER03, and SER04)

3.8 kg (including SER01 or SER04, SER02, and SER03)

#### Accessories

Power cord.....	2
Cover/Inlet stopper .....	2
CD-ROM (Logo App, instruction manual).....	1

## 5. SPECIFICATIONS

### 5.3 LT 4610SER01 (GPS/TC)

#### 5.3.1 GPS Lock

Compliant Phase Control Standard	SMPTE ST 2059-1
GPS Input Connector	
Connector	1 BNC connector
Input Impedance	50 $\Omega$
Antenna, Pre-amp Power Supply	
Voltage	5 V / 3.3 V / OFF
Current	50 mA max. (built-in overcurrent protection circuit)
GPS Receiver	
Receive Frequency	1575.42 MHz (L1)
Receive Code	C/A code
Receive Sensitivity	-130 dBm or more (input level to the antenna)
Status	NO SIGNAL, TRACKING, LOCKED, STAY IN SYNC
Holdover Function	Retains the previous frequency and phase when the GPS signal is interrupted

#### 5.3.2 CW I/O

CW I/O Connector	
Connector	1 BNC connector (shared input and output)
Input Impedance	50 $\Omega$
Input Signal Level	0.5 to 2 Vp-p
Input Signal Frequency	10 MHz
Locking Frequency Range	$\pm 5$ ppm
Output Signal Level	3.3 V LVCMOS
Output Signal Frequency	10 MHz / 1 PPS
Holdover Function	Retains the previous frequency when the 10 MHz CW signal is interrupted

#### 5.3.3 LTC I/O

I/O Connectors	
Connector	D-SUB 15 pin (shared input and output)
LTC	
Number of Inputs	1
Input Impedance	600 $\Omega$ balanced
Input Signal Level	0.5 to 4 Vp-p
Number of Outputs	3
Output Impedance	600 $\Omega$ balanced
Output Signal Level	2 Vp-p $\pm 10\%$
Alarm	
Number of Outputs	2
Output Signal Level	5 V CMOS

## 5. SPECIFICATIONS

### 5.3.4 Time Code

Reference Time	Internal / GPS / LTC / VITC
Frame Rate	Synchronizes to ANALOG BLACK 1 (LTC OUT)
Dropped Frame Mode	On / Off
ATC Setting	
LTC Insertion Setting	On / Off
LTC Setting	
Output Setting	On / Off
AES/EBU Time Code Insertion Setting	On / Off
Leap Second	
Application Setting	Set the application date/time with a timer
Daylight Savings Time	
Application Setting	Set the application date/time with a timer

## 5. SPECIFICATIONS

### 5.4 LT 4610SER02 (12G-SDI)

#### 5.4.1 Compliant Standards

SDI Embedded Audio

12G, 3G, HD, HD (DL) SMPTE ST 299

SD SMPTE ST 272

SDI Payload ID SMPTE ST 352

#### 5.4.2 SDI Formats and Standards

The SDI format is the same for all four outputs.

SD Video Signal Formats and Standards

Color System	Quantization	Image	Field Frequency/Scanning	Compliant Standards
Y <sub>C</sub> R 4:2:2	10 bit	720×487	59.94/I	SMPTE ST 259
		720×576	50/I	

HD Video Signal Formats and Standards

Color System	Quantization	Image	Frame (Field) Frequency/Scanning	Compliant Standards
Y <sub>C</sub> R 4:2:2	10 bit	1280×720	60/59.94/50/30/29.97/25/24/23.98/P	SMPTE ST 292-1 SMPTE ST 296
			60/59.94/50/I	SMPTE ST 274
		1920×1080	30/29.97/25/24/23.98/P 30/29.97/25/24/23.98/PsF	SMPTE ST 292-1

## 5. SPECIFICATIONS

### 3G-A Video Signal Formats and Standards

Color System	Quantization	Image	Frame (Field) Frequency/Scanning	Compliant Standards	
Y <sub>C</sub> B <sub>C</sub> R 4:2:2	10 bit	1920×1080	60/59.94/50/P	SMPTE ST 274 SMPTE ST 425-1	
		2048×1080	60/59.94/50/48/47.95/P	SMPTE ST 425-1 SMPTE ST 2048-2	
	12 bit	1920×1080	60/59.94/50/I	SMPTE ST 274 SMPTE ST 425-1	
			30/29.97/25/24/23.98/P		
			30/29.97/25/24/23.98/PsF		
		2048×1080	30/29.97/25/24/23.98/P 30/29.97/25/24/23.98/PsF	SMPTE ST 425-1 SMPTE ST 2048-2	
Y <sub>C</sub> B <sub>C</sub> R 4:4:4	10 bit	1280×720	60/59.94/50/30/29.97/25/24/23.98/P	SMPTE ST 296 SMPTE ST 425-1	
		1920×1080	60/59.94/50/I	SMPTE ST 274 SMPTE ST 425-1	
			30/29.97/25/24/23.98/P		
			30/29.97/25/24/23.98/PsF		
		2048×1080	30/29.97/25/24/23.98/P 30/29.97/25/24/23.98/PsF	SMPTE ST 425-1 SMPTE ST 2048-2	
			12 bit	1920×1080	60/59.94/50/I
	30/29.97/25/24/23.98/P				
	2048×1080	30/29.97/25/24/23.98/P 30/29.97/25/24/23.98/PsF		SMPTE ST 425-1 SMPTE ST 2048-2	
		RGB 4:4:4		10 bit	1280×720
	1920×1080		60/59.94/50/I		SMPTE ST 274 SMPTE ST 425-1
30/29.97/25/24/23.98/P					
30/29.97/25/24/23.98/PsF					
2048×1080	30/29.97/25/24/23.98/P 30/29.97/25/24/23.98/PsF		SMPTE ST 425-1 SMPTE ST 2048-2		
	12 bit		1920×1080		60/59.94/50/I
30/29.97/25/24/23.98/P					
2048×1080			30/29.97/25/24/23.98/P 30/29.97/25/24/23.98/PsF	SMPTE ST 425-1 SMPTE ST 2048-2	

## 5. SPECIFICATIONS

### 3G-B-DL, HD (DL) Video Signal Formats and Standards

Color System	Quantization	Image	Frame (Field) Frequency/Scanning	Compliant Standards
YCbCr 4:2:2	10 bit	1920×1080	60/59.94/50/P	SMPTE ST 274 SMPTE ST 372 SMPTE ST 425-1
		2048×1080	60/59.94/50/48/47.95/P	SMPTE ST 372 SMPTE ST 425-1 SMPTE ST 2048-2
	12 bit	1920×1080	60/59.94/50/I	SMPTE ST 274
			30/29.97/25/24/23.98/P	SMPTE ST 372
			30/29.97/25/24/23.98/PsF	SMPTE ST 425-1
		2048×1080	30/29.97/25/24/23.98/P	SMPTE ST 372
	30/29.97/25/24/23.98/PsF		SMPTE ST 425-1 SMPTE ST 2048-2	
	YCbCr 4:4:4	10 bit	1920×1080	60/59.94/50/I
30/29.97/25/24/23.98/P				SMPTE ST 372
30/29.97/25/24/23.98/PsF				SMPTE ST 425-1
2048×1080			30/29.97/25/24/23.98/P	SMPTE ST 372
			30/29.97/25/24/23.98/PsF	SMPTE ST 425-1 SMPTE ST 2048-2
12 bit		1920×1080	60/59.94/50/I	SMPTE ST 274
			30/29.97/25/24/23.98/P	SMPTE ST 372
			30/29.97/25/24/23.98/PsF	SMPTE ST 425-1
		2048×1080	30/29.97/25/24/23.98/P	SMPTE ST 372
			30/29.97/25/24/23.98/PsF	SMPTE ST 425-1 SMPTE ST 2048-2
RGB 4:4:4	10 bit	1920×1080	60/59.94/50/I	SMPTE ST 274
			30/29.97/25/24/23.98/P	SMPTE ST 372
			30/29.97/25/24/23.98/PsF	SMPTE ST 425-1
		2048×1080	30/29.97/25/24/23.98/P	SMPTE ST 372
			30/29.97/25/24/23.98/PsF	SMPTE ST 425-1 SMPTE ST 2048-2
	12 bit	1920×1080	60/59.94/50/I	SMPTE ST 274
			30/29.97/25/24/23.98/P	SMPTE ST 372
			30/29.97/25/24/23.98/PsF	SMPTE ST 425-1
		2048×1080	30/29.97/25/24/23.98/P	SMPTE ST 372
			30/29.97/25/24/23.98/PsF	SMPTE ST 425-1 SMPTE ST 2048-2

\* For 3G-B-DL, SDI1 settings apply to SDI1 and SDI2, and SDI3 settings apply to SDI3 and SDI4.

### 3G-B-DS Video Signal Formats and Standards

Color System	Quantization	Image	Frame (Field) Frequency/Scanning	Compliant Standards
YCbCr 4:2:2	10 bit	1920×1080	60/59.94/50/I	SMPTE ST 274
			30/29.97/25/24/23.98/P	SMPTE ST 425-1
			30/29.97/25/24/23.98/PsF	
	1280×720	60/59.94/50/30/29.97/P	SMPTE ST 296 SMPTE ST 425-1	

\* Only SDI1 and SDI3 are supported.

## 5. SPECIFICATIONS

### 3G(DL)-2K Video Signal Formats and Standards

Color System	Quantization	Image	Frame (Field) Frequency/Scanning	Compliant Standards
YCbCr 4:2:2	12 bit	1920×1080	60/59.94/50/P	SMPTE ST 274 SMPTE ST 425-3
		2048×1080	60/59.94/50/48/47.95/P	SMPTE ST 2048-2 SMPTE ST 425-3
YCbCr 4:4:4	10 bit	1920×1080	60/59.94/50/P	SMPTE ST 274 SMPTE ST 425-3
		2048×1080	60/59.94/50/48/47.95/P	SMPTE ST 2048-2 SMPTE ST 425-3
	12 bit	1920×1080	60/59.94/50/P	SMPTE ST 274 SMPTE ST 425-3
		2048×1080	60/59.94/50/48/47.95/P	SMPTE ST 2048-2 SMPTE ST 425-3
RGB 4:4:4	10 bit	1920×1080	60/59.94/50/P	SMPTE ST 274 SMPTE ST 425-3
		2048×1080	60/59.94/50/48/47.95/P	SMPTE ST 2048-2 SMPTE ST 425-3
	12 bit	1920×1080	60/59.94/50/P	SMPTE ST 274 SMPTE ST 425-3
		2048×1080	60/59.94/50/48/47.95/P	SMPTE ST 2048-2 SMPTE ST 425-3

### 3G(DL)-4K Video Signal Formats and Standards

Division Transmission System	Color System	Quantization	Image	Frame Frequency/Scanning	Compliant Standards
Square	YCbCr 4:2:2	10 bit	3840×2160	30/29.97/25/24/23.98/P	SMPTE ST 425-3 SMPTE ST 2036-1
			4096×2160	30/29.97/25/24/23.98/P	SMPTE ST 425-3 SMPTE ST 2048-1
2 sample interleave	YCbCr 4:2:2	10 bit	3840×2160	30/29.97/25/24/23.98/P	SMPTE ST 425-3 SMPTE ST 2036-1
			4096×2160	30/29.97/25/24/23.98/P	SMPTE ST 425-3 SMPTE ST 2048-1

### HD (QL) Video Signal Formats and Standards

Division Transmission System	Color System	Quantization	Image	Frame Frequency/Scanning	Compliant Standards
Square	YCbCr 4:2:2	10 bit	3840×2160	30/29.97/25/24/23.98/P	-
				30/29.97/25/24/23.98/PsF	-
			4096×2160	30/29.97/25/24/23.98/P	-
				30/29.97/25/24/23.98/PsF	-

## 5. SPECIFICATIONS

### 3G (QL) Video Signal Formats and Standards

Division Transmission System	Color System	Quantization	Image	Frame Frequency/Scanning	Compliant Standards	
Square	YCbCr 4:2:2	10 bit	3840×2160	60/59.94/50/P	SMPTE ST 425-5 SMPTE ST 2036-1	
			4096×2160	60/59.94/50/48/47.95/P	SMPTE ST 425-5 SMPTE ST 2048-1	
		12 bit	3840×2160	30/29.97/25/24/23.98/P	SMPTE ST 425-5 SMPTE ST 2036-1	
			4096×2160	30/29.97/25/24/23.98/P	SMPTE ST 425-5 SMPTE ST 2048-1	
	YCbCr 4:4:4	10 bit	3840×2160	30/29.97/25/24/23.98/P	SMPTE ST 425-5 SMPTE ST 2036-1	
			4096×2160	30/29.97/25/24/23.98/P	SMPTE ST 425-5 SMPTE ST 2048-1	
		12 bit	3840×2160	30/29.97/25/24/23.98/P	SMPTE ST 425-5 SMPTE ST 2036-1	
			4096×2160	30/29.97/25/24/23.98/P	SMPTE ST 425-5 SMPTE ST 2048-1	
	RGB 4:4:4	10 bit	3840×2160	30/29.97/25/24/23.98/P	SMPTE ST 425-5 SMPTE ST 2036-1	
			4096×2160	30/29.97/25/24/23.98/P	SMPTE ST 425-5 SMPTE ST 2048-1	
		12 bit	3840×2160	30/29.97/25/24/23.98/P	SMPTE ST 425-5 SMPTE ST 2036-1	
			4096×2160	30/29.97/25/24/23.98/P	SMPTE ST 425-5 SMPTE ST 2048-1	
	2 sample interleave	YCbCr 4:2:2	10 bit	3840×2160	60/59.94/50/P	SMPTE ST 425-5 SMPTE ST 2036-1
				4096×2160	60/59.94/50/48/47.95/P	SMPTE ST 425-5 SMPTE ST 2048-1
			12 bit	3840×2160	30/29.97/25/24/23.98/P	SMPTE ST 425-5 SMPTE ST 2036-1
				4096×2160	30/29.97/25/24/23.98/P	SMPTE ST 425-5 SMPTE ST 2048-1
YCbCr 4:4:4		10 bit	3840×2160	30/29.97/25/24/23.98/P	SMPTE ST 425-5 SMPTE ST 2036-1	
			4096×2160	30/29.97/25/24/23.98/P	SMPTE ST 425-5 SMPTE ST 2048-1	
		12 bit	3840×2160	30/29.97/25/24/23.98/P	SMPTE ST 425-5 SMPTE ST 2036-1	
			4096×2160	30/29.97/25/24/23.98/P	SMPTE ST 425-5 SMPTE ST 2048-1	
RGB 4:4:4		10 bit	3840×2160	30/29.97/25/24/23.98/P	SMPTE ST 425-5 SMPTE ST 2036-1	
			4096×2160	30/29.97/25/24/23.98/P	SMPTE ST 425-5 SMPTE ST 2048-1	
		12 bit	3840×2160	30/29.97/25/24/23.98/P	SMPTE ST 425-5 SMPTE ST 2036-1	
			4096×2160	30/29.97/25/24/23.98/P	SMPTE ST 425-5 SMPTE ST 2048-1	



## 5. SPECIFICATIONS

### 12G Video Signal Formats and Standards

Division Transmission System	Color System	Quantization	Image	Frame Frequency/Scanning	Compliant Standards
2 sample interleave	Y <sub>C</sub> B <sub>C</sub> R 4:2:2	10 bit	3840×2160	60/59.94/50/P	SMPTE ST 2082-10 SMPTE ST 2036-1
			4096×2160	60/59.94/50/48/47.95/P	SMPTE ST 2082-10 SMPTE ST 2036-1
		12 bit	3840×2160	30/29.97/25/24/23.98/P	SMPTE ST 2082-10 SMPTE ST 2036-1
			4096×2160	30/29.97/25/24/23.98/P	SMPTE ST 2082-10 SMPTE ST 2036-1
	Y <sub>C</sub> B <sub>C</sub> R 4:4:4	10 bit	3840×2160	30/29.97/25/24/23.98/P	SMPTE ST 2082-10 SMPTE ST 2036-1
			4096×2160	30/29.97/25/24/23.98/P	SMPTE ST 2082-10 SMPTE ST 2036-1
		12 bit	3840×2160	30/29.97/25/24/23.98/P	SMPTE ST 2082-10 SMPTE ST 2036-1
			4096×2160	30/29.97/25/24/23.98/P	SMPTE ST 2082-10 SMPTE ST 2036-1
	RGB 4:4:4	10 bit	3840×2160	30/29.97/25/24/23.98/P	SMPTE ST 2082-10 SMPTE ST 2036-1
			4096×2160	30/29.97/25/24/23.98/P	SMPTE ST 2082-10 SMPTE ST 2036-1
		12 bit	3840×2160	30/29.97/25/24/23.98/P	SMPTE ST 2082-10 SMPTE ST 2036-1
			4096×2160	30/29.97/25/24/23.98/P	SMPTE ST 2082-10 SMPTE ST 2036-1

## 5. SPECIFICATIONS

### 5.4.3 SDI Output Connector

Connector	4 BNC connectors
12G, 3G-A, HD, SD	4 outputs
3G-B, HD (DL)	2 outputs
Output Impedance	75 $\Omega$
Output Amplitude	800 mVp-p $\pm$ 10%
Output Return Loss	
5 MHz to 1.485 GHz	15 dB or more
1.485 to 2.97 GHz	10 dB or more
2.97 to 6 GHz	7 dB or more
6 to 12 GHz	4 dB or more
Rise and Fall Times	
12G	$\leq$ 45 ps (20 to 80%)
3G	$\leq$ 135 ps (20 to 80%)
HD, HD (DL)	$\leq$ 270 ps (20 to 80%)
SD	0.4 ns to 1.5 ns (20 to 80%)
DC Offset	0 $\pm$ 0.5 V

### 5.4.4 SDI Pattern Generation

The SDI pattern generation settings can be set separately for each output. But the fixed pattern and user pattern cannot be generated simultaneously.

#### SDI Signal

##### Bit Rate

12G	11.880 Gbps, 11.880/1.001 Gbps
3G	2.970 Gbps, 2.970/1.001 Gbps
HD, HD (DL)	1.485Gbps, 1.485/1.001Gbps
SD	270Mbps

#### Timing Adjustment

##### Adjustment Range

Entire frame

##### Adjustment Unit

V

Lines

H

Clocks (148.5 MHz, 148.5/1.001 MHz, 74.25 MHz, 74.25/1.001 MHz, 27 MHz)

## 5. SPECIFICATIONS

### Test Patterns

12G, 3G, HD

100% color bar, 75% color bar,  
multiformat color bar (ARIB STD-B28, pattern 2  
area can be set to 100% white, 75% white, or +I),  
ARIB STD-B66-2 color bar (3G(QL) 2 sample  
interleave, and 12G 422 (YCbCr) 10bit only),  
check field (3G, HD),  
flat field white 100%, black 0%, red 100%, green  
100%, blue 100%

SD

525/59.94I

100% color bar, 75% color bar,  
SMPTE color bar, check field,  
flat field white 100%, black 0%, red 100%, green  
100%, blue 100%

625/50I

100% color bar, EBU color bar,  
BBC color bar, check field,  
flat field white 100%, black 0%, red 100%, green  
100%, blue 100%

Automatic Switching

Automatically switches between selectable color bar  
patterns

Switch Time

1 to 255 sec

- \* The selectable patterns depend on the SDI format.
- \* In ARIB STD-B66-2 color bar display, the color system is 422(YCbCr) 10 bit.

## 5. SPECIFICATIONS

User Pattern Display	Select one from INT-1 to 8.
Storage Memory	SD, HD (2K), 4K, up to 25 patterns each
Display Memory (INT_1 to 8)	Transfer the SD, HD (2K), 4K (2SI), 4K (SQD) pattern data (up to 8 patterns each) from the storage memory to the display memory
File Format	24-bit full color bitmap format (.bmp) TIFF format (.tif), IMG format (.img)
Archiver Pattern	IMG format (.img)
UHDColorBar	ARIB STD-B66 UHDTV MULTIFORMAT COLOR BAR (3G(QL) 2 sample interleave, and 12G 422 (YCbCr) 10bit only)
HLGCB	ARIB STD-B72 Colour Bar Test Pattern for HLG HDR-TV System Recommendation ITU-R BT.2111 HLG (3G(QL) and 12G 422 (YCbCr) 10bit only)
SLog3_LiveHDR_narrow_V11	S-Log3(Live HDR) Ver1.11 narrow range scale (HD and 3G(QL) 2 sample interleave, and 12G 422 (YCbCr) 10bit only)

- \* After turning on the power, transfer the data from the storage memory to the display memory. It takes about 5 minutes to transfer the data of a 4K user pattern. If the power is cut off after a memory transfer, the data in the display memory will be cleared. The data in the storage memory will be retained even when the power is turned off, so after turning on the power, perform a memory transfer operation again. You can also set the power on load function that automatically transfers data after the power is turned on.
- \* If the power is cut off while data is being accessed, the data may become corrupted. Do not turn off the power while data is being accessed.
- \* In the user pattern display, the color system is 422(YCbCr) 10 bit.

### Component On/Off

Function	Each of the Y/G, Cb/B, and Cr/R components can be turned on and off independently.
----------	--

- \* Not available when the check field pattern is selected.

### Safety Area Markers

12G, 3G, HD	Action safe area (90%) Title safe area (80%) 4:3 aspect ratio (can be turned on and off separately)
SD	Action safe area (90%) Title safe area (80%) (can be turned on and off separately)

- \* Not available when the check field pattern or user pattern is selected.

## 5. SPECIFICATIONS

### Moving Box

Box Color	Select from white, yellow, cyan, green, blue, red, magenta, black
Speed Setting V/H	LOW / MIDDLE / HIGH
Size Setting V/H	SIZE 1 to 5

\* Not available when the check field pattern is selected.

### Pattern Scrolling

Direction	Eight directions (up, down, left, right, and their combinations)
-----------	--

### Speed Range and Unit

Interlace	In unit of fields
V	0 to 256 lines, in 1 line steps
H	0 to 256 dots, in 2 dot steps
Progressive	In unit of frames
V	0 to 256 lines, in 1 line steps
H	0 to 256 dots, in 2 dot steps

\* Not available when the check field pattern is selected.

### ID Characters

Number of Characters	Up to 20 characters
Size [Dots]	32×32 / 64×64 / 128×128 / 256×256
Intensity	100%, 75% (black only for the background color)
Display Position	Anywhere on the display
Display Position Adjustment Resolution	
V	1 line
H	1 dot
Blinking Display (*1)	ON / OFF
ON TIME	1 to 9 sec, in 1 sec step
OFF TIME	1 to 9 sec, in 1 sec step
Blinking Display (*1)	OFF, 1 to 9 sec
Scrolling (*1)	
Function	Scroll including the ID character background
Direction	Two directions (left and right)
Speed Range and Unit	
Interlace	In unit of fields
H	0 to 256 dots, in 2 dot steps
Progressive	In unit of frames
H	0 to 256 dots, in 2 dot steps

\* Not available when the check field pattern is selected.

\*1 The blinking display and scrolling can be used simultaneously.

## 5. SPECIFICATIONS

### Logo Mark

Logo Mark Data	4-level monochrome data from level 0 to 3
Maximum Size	320 (dots) × 240 (lines) (QVGA size)
Number of Logo Marks That Can Be Saved in the LT 4610	Up to 4
Display Position	Anywhere on the display
Display Position Adjustment Resolution	
V	1 line
H	1 dot
Display Level	Any level from 0 to 3
File Format	
Before Conversion	24-bit full color bitmap format (.bmp)
After Conversion	Original format (.lg)
Conversion Color Matrix	$Y = (0.212 \times R) + (0.701 \times G) + (0.087 \times B)$ Converts 256-level monochrome data (Y) to 4 levels (levels 0 to 3) using specified thresholds
Conversion Method	Using the logo application
Logo Mark Data Transfer	Save the data to a USB memory device and transfer to the LT 4610.

\* Not available when the check field pattern is selected.

### Image Overlay

Display Precedence	ID characters > safety area markers > logo mark > test pattern (The display order cannot be changed.)
Simultaneous Display	ID characters, logo mark, safety area markers, and test pattern can be displayed simultaneously.

### Embedded Audio

Embedded Channels	Can be turned on and off at the group level
3G-A, HD, SD	16 channels (4 channels × 4 groups)
3G-B	32 channels (stream 1, stream 2, 4 channels each × 4 groups)
Sampling Frequency	48 kHz sampling (syncd with the video signal)
Resolution	20 bits, 24 bits
Pre-emphasis	OFF, 50/15, CCITT (only the CS bit is switched)
Frequency	SILENCE / 400Hz / 800Hz / 1kHz
Level	-60 to 0 dBFS (1 dBFS steps)
Audio Click	OFF, 1 / 2 / 4 sec

\* Audio (including packets) cannot be embedded when the check field pattern is selected.

\* The frequency, level, and audio click can be set for each channel.

\* The following limitations apply for SD (525/59.94I).

- For 16 channel output, the resolution is set to 20 bits.
- Up to three groups (12 channels) can be output at 24-bit resolution.

## 5. SPECIFICATIONS

### 5.4.5 Lip Sync Patterns

Setting SDI1, SDI2, SDI3, and SDI4 can be set separately.

- \* Not available when the check field pattern is selected.
- \* The audio click setting of embedded audio is disabled, and audio synchronized to the lip sync pattern is output.

### 5.4.6 User Payload ID

Setting ON / OFF

- \* You can edit the user payload ID only in a web browser.

## 5. SPECIFICATIONS

### 5.5 LT 4610SER03 (PTP)

#### 5.5.1 Compliant Standards

Internet Protocol Version	IPv4
PTP Standard	IEEE 1588-2008
Supported Profile	SMPTE ST 2059 / AES67 / General

#### 5.5.2 RJ-45 Port

Number of Ports	1
Port Type	RJ-45
Compliant Standards	IEEE 802.3
Type	10Base-T / 100Base-TX / 1000Base-T

#### 5.5.3 SFP / SFP+ Port

Number of Ports	1
Port Type	SFP cage
Compliant Standards	MSA
Supported Modules and Types	
SFP transceiver RJ-45	1000BASE-T
SFP+ optical transceiver	10GBASE-SR and 10GBASE-SW

\* The SFP/SFP+ module is optional.

#### 5.5.4 Master Function

Number of Controllable Master Devices	2
Communication Mode	Multicast / Unicast / MIXED SMPTE / MIXED SMPTE without negotiation
Domain Number	0 to 127 (SMPTE ST 2059) 0 to 255 (AES67 / General)
Announce Message Rate	0.125s 8Hz / 0.25s 4Hz / 0.5s 2Hz / 1s 1Hz / 2s 0.5Hz / 4s 0.25Hz / 8s 0.125Hz / 16s 0.0625Hz
Sync Message Rate	0.0078s 128Hz / 0.015s 64Hz / 0.0312s 32Hz / 0.625s 16Hz / 0.125s 8Hz / 0.25s 4Hz / 0.5s 2Hz / 1s 1Hz / 2s 0.5Hz 4s 0.25Hz / 8s 0.125Hz / 16s 0.0625Hz

\* The message rate setting range varies depending on the profile.

Priority 1	0 to 255
Priority 2	0 to 255
Number of Connectable Slaves	1000

\* When the sync message rate is 8Hz in theoretical value.



## 5. SPECIFICATIONS

### 5.5.5 Slave Function

Communication Mode	Multicast / Unicast / MIXED SMPTE / MIXED SMPTE without negotiation
Domain Number	0 to 127 (SMPTE ST 2059) 0 to 255 (AES67 / General)
Delay Message Rate	0.0078s 128Hz / 0.015s 64Hz / 0.0312s 32Hz / 0.0625s 16Hz / 0.125s 8Hz / 0.25s 4Hz / 0.5s 2Hz / 1s 1Hz / 2s 0.5Hz / 4s 0.25Hz / 8s 0.125Hz / 16s 0.0625Hz
Announce Timeout Count	2 to 10

## 5. SPECIFICATIONS

### 5.6 LT 4610SER04 (GPS/BDS)

#### 5.6.1 GNSS Lock

Compliant Phase Control Standard	SMPTE ST 2059-1
GNSS Input Connector	
Connector	1 BNC connector
Input Impedance	50 $\Omega$
Antenna, Pre-amp Power Supply	
Voltage	5 V / 3.3 V / OFF
Current	50 mA max. (built-in overcurrent protection circuit)
GNSS Receiver	
Receive Frequency	
GPS	1575.42MHz (L1)
BDS	1561.098MHz (B1)
Receive Sensitivity	GPS : -130dBm or more (input level to the antenna) BDS : -120dBm or more (input level to the antenna)
Status	NO SIGNAL, TRACKING, LOCKED, STAY IN SYNC
Holdover Function	Retains the previous frequency and phase when the GPS signal or GPS signal is interrupted

#### 5.6.2 CW I/O

CW I/O Connector	
Connector	1 BNC connector (shared input and output)
Input Impedance	50 $\Omega$
Input Signal Level	0.5 to 2 Vp-p
Input Signal Frequency	10 MHz
Locking Frequency Range	$\pm 5$ ppm
Output Signal Level	3.3 V LVCMOS
Output Signal Frequency	10 MHz / 1 PPS
Holdover Function	Retains the previous frequency when the 10 MHz CW signal is interrupted

#### 5.6.3 LTC I/O

I/O Connectors	
Connector	D-SUB 15 pin (shared input and output)
LTC	
Number of Inputs	1
Input Impedance	600 $\Omega$ balanced
Input Signal Level	0.5 to 4 Vp-p
Number of Outputs	3
Output Impedance	600 $\Omega$ balanced
Output Signal Level	2 Vp-p $\pm 10\%$
Alarm	
Number of Outputs	2
Output Signal Level	5 V CMOS

## 5. SPECIFICATIONS

### 5.6.4 Time Code

Reference Time	Internal / GNSS
Frame Rate	Synchronizes to ANALOG BLACK 1 (LTC OUT)
Dropped Frame Mode	On / Off
ATC Setting	
LTC Insertion Setting	On / Off
LTC Setting	
Output Setting	On / Off
AES/EBU Time Code Insertion Setting	On / Off
Leap Second	
Application Setting	Set the application date/time with a timer
Daylight Savings Time	
Application Setting	Set the application date/time with a timer

## 5. SPECIFICATIONS

### 5.7 LT 4611SER21 (SYNC 3 OUT ADD)

Software option for the LT 4611 only. It is a standard feature on the LT 4610.

#### 5.7.1 Compliant Standards

Analog Video Sync Signal	
NTSC Black Burst Signal	SMPTE ST 170, SMPTE ST 318, SMPTE RP 154
PAL Black Burst Signal	ITU-R BT 1700, EBU N14
HD Tri-Level Sync Signal	SMPTE ST 240, SMPTE ST 274, SMPTE ST 296

#### 5.7.2 Output Connectors

##### Analog Video Sync Signal Output Connector

Connector	3 BNC connectors, 3 outputs
Output Signal	NTSC black burst signal, PAL black burst signal, HD tri-level sync signal
Output Impedance	75 $\Omega$
Sync Level	
NTSC	40 $\pm$ 1 IRE
PAL	-300 $\pm$ 6mV
HD	$\pm$ 300 $\pm$ 6mV
Blanking	0 $\pm$ 15mV

#### 5.7.3 Analog Video Sync Signal Output

Signal Formats	Each of the 3 outputs can be set separately. NTSC BB, NTSC BB+REF, NTSC BB+ID, NTSC BB+REF+ID, NTSC BB+SETUP, NTSC BB+S+REF, NTSC BB+S+ID, NTSC BB+S+R+ID, PAL BB, PAL BB+REF, 525/59.94I, 525/59.94P, 625/50I, 625/50P, 1125/60I, 1125/59.94I, 1125/50I, 1125/30P, 1125/29.97P, 1125/25P, 1125/24P, 1125/23.98P, 1125/24PsF, 1125/23.98PsF, 750/60P, 750/59.94P, 750/50P, 750/30P, 750/29.97P, 750/25P, 750/24P, 750/23.98P
Timing Adjustment	Can be set separately for each of the 3 outputs
Adjustment Range	
NTSC Black Burst Signal	$\pm$ 5 frames
PAL Black Burst Signal	$\pm$ 2 frames
HD Tri-Level Sync Signal	1 frame (entire frame)
Adjustment Unit	
NTSC/PAL Black Burst Signal	In units of 0.0185 $\mu$ s (54 MHz clock unit)
HD Tri-Level Sync Signal	In units of 0.0135 $\mu$ s (74.25/1.001 MHz clock unit or 74.25 MHz clock unit)

## 5. SPECIFICATIONS

### 5.8 LT 4611SER22 (SDI OUTPUT)

Software option for the LT 4611 only. It is a standard feature on the LT 4610.

#### 5.8.1 Compliant Standards

SDI Embedded Audio

3G, HD, HD (DL)

SMPTE ST 299

SD

SMPTE ST 272

SDI Payload ID

SMPTE ST 352

#### 5.8.2 SDI Formats and Standards

HD, SD Video Signal Formats and Standards

Color System	Quantization	Image	Frame (Field) Frequency/Scanning	Compliant Standards
YCbCr 4:2:2	10 bit	1280×720	60/59.94/50/30/29.97/25/24/23.98/P	SMPTE ST 292 SMPTE ST 296
		1920×1080	60/59.94/50/I	SMPTE ST 292
			30/29.97/25/24/23.98/P	SMPTE ST 274
			24/23.98/PsF	SMPTE ST 292 SMPTE RP 211
		720×487	59.94/I	SMPTE ST 259
		720×576	50/I	SMPTE ST 125

HD (DL) Video Signal Formats and Standards

Color System	Quantization	Image	Frame (Field) Frequency/Scanning	Compliant Standards
YCbCr 4:2:2	10 bit	1920×1080	60/59.94/50/P	SMPTE ST 274 SMPTE ST 372
	12 bit	1920×1080	60/59.94/50/I	
			30/29.97/25/24/23.98/P	
			30/29.97/25/24/23.98/PsF	
YCbCr 4:4:4	10 bit	1920×1080	60/59.94/50/I	
	12 bit		30/29.97/25/24/23.98/P	
			30/29.97/25/24/23.98/PsF	
RGB 4:4:4	10 bit	1920×1080	60/59.94/50/I	
	12 bit		30/29.97/25/24/23.98/P	
			30/29.97/25/24/23.98/PsF	

## 5. SPECIFICATIONS

### 3G-A Video Signal Formats and Standards

Color System	Quantization	Image	Frame (Field) Frequency/Scanning	Compliant Standards
Y <sub>C<sub>B</sub>C<sub>R</sub></sub> 4:2:2	10 bit	1920×1080	60/59.94/50/P	SMPTE ST 274 SMPTE ST 425
	12 bit	1920×1080	60/59.94/50/I	
			30/29.97/25/24/23.98/P	
			30/29.97/25/24/23.98/PsF	
Y <sub>C<sub>B</sub>C<sub>R</sub></sub> 4:4:4	10 bit	1280×720	60/59.94/50/30/29.97/25/24/23.98/P	SMPTE ST 296 SMPTE ST 425
		1920×1080	60/59.94/50/I	SMPTE ST 274 SMPTE ST 425
			30/29.97/25/24/23.98/P	
	30/29.97/25/24/23.98/PsF			
	12 bit	1920×1080	60/59.94/50/I	SMPTE ST 274 SMPTE ST 425
			30/29.97/25/24/23.98/P	
30/29.97/25/24/23.98/P				
RGB 4:4:4	10 bit	1280×720	60/59.94/50/30/29.97/25/24/23.98/P	SMPTE ST 296 SMPTE ST 425
		1920×1080	60/59.94/50/I	SMPTE ST 274 SMPTE ST 425
			30/29.97/25/24/23.98/P	
	30/29.97/25/24/23.98/PsF			
	12 bit	1920×1080	60/59.94/50/I	SMPTE ST 274 SMPTE ST 425
			30/29.97/25/24/23.98/P	
30/29.97/25/24/23.98/P				

### 3G-B Video Signal Formats and Standards

Color System	Quantization	Image	Frame (Field) Frequency/Scanning	Compliant Standards
Y <sub>C<sub>B</sub>C<sub>R</sub></sub> 4:2:2	10 bit	1920×1080	60/59.94/50/P	SMPTE ST 274 SMPTE ST 372 SMPTE ST 425
	12 bit	1920×1080	60/59.94/50/I	
			30/29.97/25/24/23.98/P	
			30/29.97/25/24/23.98/PsF	
Y <sub>C<sub>B</sub>C<sub>R</sub></sub> 4:4:4	10 bit	1920×1080	60/59.94/50/I	SMPTE ST 274 SMPTE ST 372 SMPTE ST 425
			30/29.97/25/24/23.98/P	
			30/29.97/25/24/23.98/PsF	
	12 bit	1920×1080	60/59.94/50/I	
			30/29.97/25/24/23.98/P	
RGB 4:4:4	10 bit	1920×1080	60/59.94/50/I	SMPTE ST 274 SMPTE ST 372 SMPTE ST 425
			30/29.97/25/24/23.98/P	
			30/29.97/25/24/23.98/PsF	
	12 bit	1920×1080	60/59.94/50/I	
			30/29.97/25/24/23.98/P	

## 5. SPECIFICATIONS

### 5.8.3 Output Connectors

#### SDI Output Connector

Connector	2 BNC connectors
3G-A, HD, SD	2 outputs
3G-B, HD (DL)	1 outputs
Output Impedance	75Ω
Output Amplitude	800mVp-p±10%
Output Return Loss	
5 MHz to 1.485 GHz	15 dB or more
1.485 to 2.97 GHz	10 dB or more
Overshoot	Less than 10%
Rise and Fall Times	
3G	≤ 135 ps (20 to 80%)
HD, HD (DL)	≤ 270 ps (20 to 80%)
SD	0.4 ns to 1.5 ns (20 to 80%)
DC Offset	0±0.5V

### 5.8.4 SDI Video Output

#### SDI Signal

Bit Rate	
3G	2.970Gbps, 2.970/1.001Gbps
HD, HD (DL)	1.485Gbps, 1.485/1.001Gbps
SD	270Mbps

#### Timing Adjustment

Adjustment Range	Entire frame
Adjustment Unit	
V	Lines
H	Clocks (148.5 MHz, 148.5/1.001 MHz, 74.25 MHz, 74.25/1.001 MHz, 27 MHz)

#### Test Patterns

3G, HD	100% color bar, 75% color bar, multiformat color bar (ARIB STD-B28, pattern 2 area can be set to 100% white, 75% white, or +I), check field, flat field white 100%, black 0%, red 100%, green 100%, blue 100%
SD	
525/59.94I	100% color bar, 75% color bar, SMPTE color bar, check field, flat field white 100%, black 0%, red 100%, green 100%, blue 100%
625/50I	100% color bar, EBU color bar, BBC color bar, check field, flat field white 100%, black 0%, red 100%, green 100%, blue 100%

## 5. SPECIFICATIONS

Automatic Switching	Automatically switches between selectable color bar patterns
Switch Time	1 to 255 sec
Pattern Scrolling	
Direction	Eight directions (up, down, left, right, and their combinations)
Speed Range and Unit	
Interlace	In unit of fields
V	0 to 256 lines, in 1 line steps
H	0 to 256 dots, in 2 dot steps
Progressive	In unit of frames
V	0 to 256 lines, in 1 line steps
H	0 to 256 dots, in 2 dot steps

\* Not available when the check field pattern is selected.

### Safety Area Markers

3G, HD	Action safe area (90%) Title safe area (80%) 4:3 aspect ratio (can be turned on and off separately)
SD	Action safe area (90%) Title safe area (80%) (can be turned on and off separately)

\* Not available when the check field pattern is selected.

### ID Characters

Number of Characters	Up to 20 characters
Size [Dots]	32×32 / 64×64 / 128×128 / 256×256
Intensity	100%, 75% (black only for the background color)
Display Position	Anywhere on the display
Display Position Adjustment Resolution	
V	1 line
H	1 dot
Blinking Display (*1)	ON / OFF
ON TIME	1 to 9 sec, in 1 sec step
OFF TIME	1 to 9 sec, in 1 sec step
Scrolling (*1)	
Function	Scroll including the ID character background
Direction	Two directions (left and right)
Speed Range and Unit	
Interlace	In unit of fields
V	0 to 256 dots, in 2 dot steps
Progressive	In unit of frames
H	0 to 256 dots, in 2 dot steps

\* Not available when the check field pattern is selected.

\*1 The blinking display and scrolling can be used simultaneously.



## 5. SPECIFICATIONS

### Logo Mark

Logo Mark Data	4-level monochrome data from level 0 to 3
Maximum Size	320 (dots) × 240 (lines) (QVGA size)
Number of Logo Marks That Can Be Saved in the LT 4611	Up to 4
Display Position	Anywhere on the display
Display Position Adjustment Resolution	
V	1 line
H	1 dot
Display Level	Any level from 0 to 3
File Format	
Before Conversion	24-bit full color bitmap format (.bmp)
After Conversion	Original format (.lg)
Conversion Color Matrix	$Y = (0.212 \times R) + (0.701 \times G) + (0.087 \times B)$ Converts 256-level monochrome data (Y) to 4 levels (levels 0 to 3) using specified thresholds
Conversion Method	Using the logo application
Logo Mark Data Transfer	Save the data to a USB memory device and transfer to the LT 4611.

\* Not available when the check field pattern is selected.

### Component On/Off

Function	Each of the Y/G, Cb/B, and Cr/R components can be turned on and off independently.
----------	--

\* Not available when the check field pattern is selected.

### Image Overlay

Display Precedence	ID characters > logo mark > safety area markers > test pattern (The display order cannot be changed.)
Simultaneous Display	ID characters, logo mark, safety area markers, and test pattern can be displayed simultaneously.

## 5. SPECIFICATIONS

### Embedded Audio

Embedded Channels	Can be turned on and off at the group level
3G-A, HD, SD	16 channels (4 channels × 4 groups)
3G-B	32 channels (stream 1, stream 2, 4 channels each × 4 groups)
Sampling Frequency	48 kHz sampling (synced with the video signal)
Resolution	20 bits, 24 bits
Pre-emphasis	OFF, 50/15, CCITT (only the CS bit is switched)
Frequency	SILENCE / 400Hz / 800Hz / 1kHz
Level	-60 to 0 dBFS (1 dBFS steps)
Audio Click	OFF, 1 / 2 / 4 sec

- \* Audio (including packets) cannot be embedded when the check field pattern is selected.
- \* The frequency, level, and audio click can be set for each channel.
- \* The following limitations apply for SD (525/59.94I).
  - For 16 channel output, the resolution is set to 20 bits.
  - Up to three groups (12 channels) can be output at 24-bit resolution.

### 5.8.5 Lip Sync Patterns

Setting SDI1+AES/EBU and SDI2 can be set separately.

- \* Not available when the check field pattern is selected.
- \* Safety area markers, ID characters, and logo mark cannot be overlaid.
- \* The audio click setting of embedded audio is disabled, and audio synchronized to the lip sync pattern is output.

## 5. SPECIFICATIONS

### 5.9 LT 4611SER23 (AUDIO OUTPUT)

Software option for the LT 4611 only. It is a standard feature on the LT 4610.

#### 5.9.1 Compliant Standards

AES/EBU	ANSI S4.40, AES3-2009, AES11-2009, SMPTE ST 276
---------	--

#### 5.9.2 Output Connectors

##### AES/EBU Digital Audio Output Connector

Connector	1 BNC connector
Output Amplitude	1Vp-p±0.1V
Output Impedance	75 Ω unbalanced

##### AES/EBU Silence Output Connector

Connector	1 BNC connector
Output Amplitude	1Vp-p±0.1V
Output Impedance	75 Ω unbalanced

#### 5.9.3 AES/EBU Digital Audio Output

##### Timing Adjustment

Adjustment Range	±1 AES/EBU frame
Adjustment Unit	512 fs (24.576 MHz)
Sampling Frequency	48 kHz sampling (syncd with the video signal)
Resolution	20 bits, 24 bits
Pre-emphasis	OFF, 50/15, CCITT (only the CS bit is switched)
Frequency	SILENCE / 400Hz / 800Hz / 1kHz
Level	-60 to 0 dBFS (1 dBFS steps)
Audio Click	OFF, 1 / 2 / 4 sec
Lip Sync	Synchronization with SDI1
Sampling Clock Accuracy	Grade 2 (±10 ppm)

\* The frequency, level, and audio click can be set for each channel.

\* Turn off all channels to output a digital audio reference signal (DARS).

#### 5.9.4 AES/EBU Silence Output

##### Timing Adjustment

Adjustment Range	±1 AES/EBU frame
Adjustment Unit	512 fs (24.576 MHz)
Sampling Frequency	48 kHz sampling (syncd with the video signal)
Resolution	20 bits, 24 bits
Pre-emphasis	OFF
Frequency	SILENCE
Level	MUTE
Sampling Clock Accuracy	Grade 2 (±10 ppm)

## 5. SPECIFICATIONS

### 5.10 LT 4610SER24 / LT 4611SER24 (8K)

The LT 4610SER24 is a software option for the LT 4610 that adds the ability to output the 8K patterns from the 12G-SDI connectors, when the LT 4610 is equipped with the hardware option LT 4610SER02.

The LT 4611SER24 is a software option for the LT 4611 that adds the ability to output the 8K patterns from the 12G-SDI connectors, when the LT 4611 is equipped with the hardware option LT 4610SER02.

#### 5.10.1 Compliant Standard

SDI Embedded Audio	SMPTE ST 299
SDI Payload ID	SMPTE ST 352

#### 5.10.2 SDI Formats and Standards

##### 12G(QL) 8K Video Signal Formats and Standards

Division Transmission System	Color System	Quantization	Image	Frame Frequency/Scanning	Compliant Standards
2 sample interleave	YCbCr 4:2:2	10bit	7680×4320	60/59.94/50/48/47.95/P	SMPTE ST 2082-12 SMPTE ST 2036-1
		12bit	7680×4320	30/29.97/25/24/23.98/P	SMPTE ST 2082-12 SMPTE ST 2036-1
	YCbCr 4:4:4	10bit	7680×4320	30/29.97/25/24/23.98/P	SMPTE ST 2082-12 SMPTE ST 2036-1
		12bit	7680×4320	30/29.97/25/24/23.98/P	SMPTE ST 2082-12 SMPTE ST 2036-1
	RGB 4:4:4	10bit	7680×4320	30/29.97/25/24/23.98/P	SMPTE ST 2082-12 SMPTE ST 2036-1
		12bit	7680×4320	30/29.97/25/24/23.98/P	SMPTE ST 2082-12 SMPTE ST 2036-1

## 5. SPECIFICATIONS

### 5.10.3 8K SDI Pattern Generation

SDI Signal	11.880 Gbps, 11.880/1.001 Gbps
Test Patterns	100% color bar, 75% color bar, flat field white 100%, black 0%, red 100%, green 100%, blue 100%
Automatic Switching	Automatically switches between selectable color bar patterns
Switch Time	1 to 255 sec
User Pattern Display	Select one from INT-1 to 8.
Storage Memory	Up to 25 patterns
Display Memory (INT_1 to 8)	Transfer the pattern data (up to 8 patterns) from the storage memory to the display memory
File Format	24-bit full color bitmap format (.bmp) TIFF format (.tif), IMG format (.img)
Archive Pattern	IMG format (.img) UHDCoLorBar ARIB STD-B66 UHDTV MULTIFORMAT COLOR BAR (12G(QL) 422(YCbCr) 10bit only) SLog3_LiveHDR_narrow_V11 S-Log3 (Live HDR) Ver1.11 narrow range scale (12G(QL) 422(YCbCr) 10bit only)

- \* After turning on the power, transfer the data from the storage memory to the display memory. It takes about 15 minutes to transfer the data of an 8K user pattern. If the power is cut off after a memory transfer, the data in the display memory will be cleared. The data in the storage memory will be retained even when the power is turned off, so after turning on the power, perform a memory transfer operation again. You can also set the power on load function that automatically transfers data after the power is turned on.
- \* If the power is cut off while data is being accessed, the data may become corrupted. Do not turn off the power while data is being accessed.
- \* In the user pattern display, the color system is 422(YCbCr) 10 bit.
- \* When user pattern display is selected, simultaneous display other than user pattern display is not possible.

#### Component On/Off

Function	Each of the Y/G, Cb/B, and Cr/R components can be turned on and off independently.
----------	---

#### Safety Area Markers

Action safe area (90%)  
Title safe area (80%)  
4:3 aspect ratio  
(can be turned on and off separately)

#### Moving Box

Box Color	Select from white, yellow, cyan, green, blue, red, magenta, black
Speed Setting V/H	LOW / MIDDLE / HIGH
Size Setting V/H	SIZE 1 to 5

- \* Not available when the user pattern is selected.

## 5. SPECIFICATIONS

Pattern Scrolling	
Direction	Eight directions (up, down, left, right, and their combinations)
Speed Range and Unit	
Progressive	In unit of fields
V	0 to 256 lines, in 4 line steps
H	0 to 256 dots, in 8 dot steps
Embedded Audio	
Embedded Channels	Can be turned on and off at the group level 16 channels (4 channels × 4 groups)
Sampling Frequency	48 kHz sampling (synced with the video signal)
Resolution	20 bits, 24 bits
Pre-emphasis	OFF, 50/15, CCITT (only the CS bit is switched)
Frequency	SILENCE / 400Hz / 800Hz / 1kHz
Level	-60 to 0 dBFS (1 dBFS steps)
Audio Click	OFF, 1 / 2 / 4 sec

\* The frequency, level, and audio click can be set for each channel.

### 5.10.4 Lip Sync Patterns

Setting	Set by SDI1
---------	-------------

### 5.10.5 User Payload ID

Setting	ON / OFF
---------	----------

\* You can edit the user payload ID only in a web browser.

## 5.11 Items Sold Separately

SFP transceiver RJ-45	
LC2141 SFP RJ-45	SFP module for 1GbE RJ-45 type
SFP+ optical transceiver	
LC2144 SFP+ MULTI-MODE	SFP+ module for 10GbE multi-mode fibers 300 m
LC2145 SFP+ SINGLE MODE	SFP+ module for 10GbE single-mode fibers 10 km

\* Modules that you purchase on the market are not supported.

## 6. PANEL DESCRIPTION

### 6.1 Front Panel

LT 4610

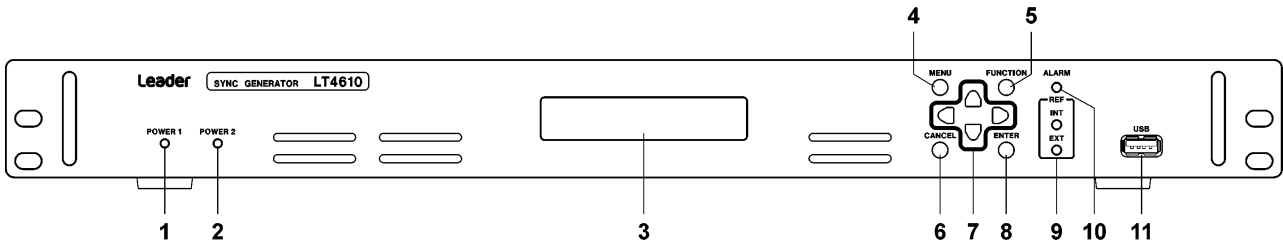

LT 4611

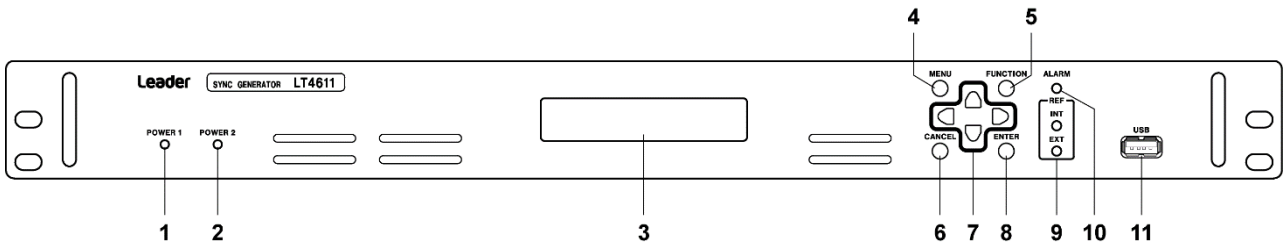

No.	Name	Description
1	POWER 1	Lights in green when the power to AC INPUT 1 is on. It lights in red when errors occur in AC INPUT 1 or when power to AC INPUT 2 is on and power to AC INPUT 1 is off.
2	POWER 2	Lights in green when the power to AC INPUT 2 is on. It lights in red when errors occur in AC INPUT 2 or when power to AC INPUT 1 is on and power to AC INPUT 2 is off.
3	LCD	Shows various information.
4	MENU	Switches the top menu or returns to the higher level menu.
5	FUNCTION	Clears the key lock.
6	CANCEL	Returns the setting to the its value.
7	Arrow keys	Used to move the cursor and to set values.
8	ENTER	Confirms values and enters a lower level menu.
9	REF	INT lights in green when the reference signal is internal. EXT lights or blinks in green when the reference signal is external. It blinks in red when operating in stay-in-sync mode.
10	ALARM	Blinks in red when an alarm occurs. It blinks in orange when an attention state occurs.
11	USB	USB port. Used to save and load various data.

## 6. PANEL DESCRIPTION

### 6.2 Rear Panel

LT 4610, LT 4611

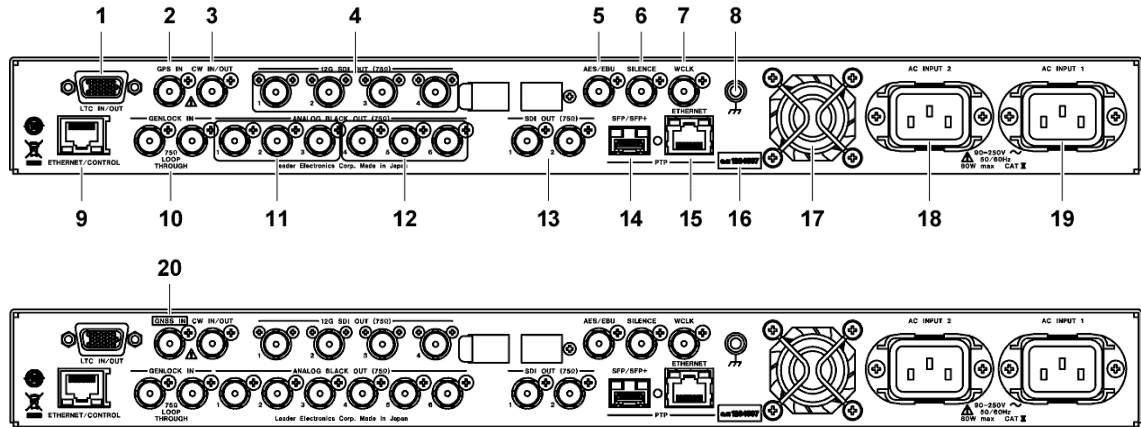

No.	Name	Description
1	LTC IN/OUT (SER01/SER04)	Time code I/O connector. It also outputs alarms.
2	GPS IN (SER01)	GPS antenna input connector.
3	CW IN/OUT (SER01/SER04)	CW I/O connector. This connector is used by switching between input and output. When set to input, it receives 10 MHz CW signals. When set to output, it outputs 10 MHz CW or 1PPS signals.
4	12G-SDI (SER02)	SDI output connectors. They output SD, HD, 3G, and 12G signals.
5	AES/EBU (SER23) (*1)	AES/EBU signal output connector.
6	SILENCE (SER23) (*1)	Muted AES/EBU signal output connector.
7	WCLK	48 kHz word-clock output connector.
8	Ground terminal	Connect to an external ground.
9	ETHERNET/CONTROL	Ethernet port. Supports SNMP and HTTP.
10	GENLOCK IN	Genlock input connectors. They are loop-through connectors. They receive HD tri-level sync or NTSC/PAL black burst signals.
11	ANALOG BLACK OUT 1 to 3	Black output connectors. They output HD tri-level sync or NTSC/PAL black burst signals.
12	ANALOG BLACK OUT 4 to 6 (SER21) (*1)	Black output connectors. They output HD tri-level sync or NTSC/PAL black burst signals.
13	SDI OUT (SER22) (*1)	SDI output connectors. Outputs SD, HD, and 3G signals.
14	SFP/SFP+ Port (SER03)	A PTP-compatible Ethernet SFP/SFP+ port. Connect an SFP or SFP+ module for use. [See also] 5.11, "Items Sold Separately"
15	RJ45 port (SER03)	A PTP-compatible Ethernet RJ45 port.
16	Serial label	The serial number is printed on this label.
17	Fan	Cooling fan for the instrument.
18	AC INPUT 2	AC inlet for the second power supply.
19	AC INPUT 1	AC inlet for the first power supply.
20	GNSS IN (SER04)	GNSS antenna input connector.

\*1 The LT 4611 can be output the signal when each of the software options is installed. It is a standard feature on the LT 4610.



## 7. BASIC OPERATION

### 7.1 Turning the Power On

- Turning the Power On

This instrument does not have a power switch. Connect the included power cords to DC INPUT 1 and DC INPUT 2 on the rear panel. Since the power supply is redundant, even if one of the power supplies fail, operation can continue with the other power supply.

POWER 1 and POWER 2 on the front panel light in green when the power is on and in red when it is not. When one of the power supplies is not on, an alarm is indicated in ALARM SYSTEM of the STATUS menu.

- Starting

When the power is turned on, this instrument starts to initialize. During initialization, you cannot use the keys.

LT 4610



LT 4611



- Startup Complete

When the following menu appears, the startup is complete.

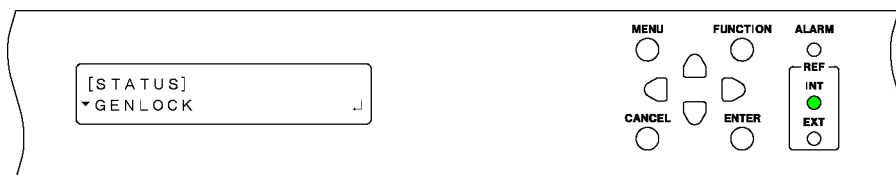

## 7. BASIC OPERATION

- Power-on Settings

The settings vary depending on the POWER ON RECALL setting on the SYSTEM menu as follows:

(Y: Settings that were used when the power was turned off previously, P: Preset settings, N: Factor default settings)

	POWER ON RECALL	
	OFF	NUMBER 0 to 9
GENLOCK menu	Y	P
LOG LIST (00 to 99)	N	N
BLACK menu (including SER21)	Y	P
SDI menu (SER22)	Y	P
ID CHARACTER (INT_1 to INT_4)	Y	Y
LOGO (INT_1 to INT_4)	Y	Y
AES/EBU menu (SER23)	Y	P
WCLK menu	Y	P
ETC menu	Y	P
GPS OPTION menu (SER01)	Y	P
CW IN/OUT	N	P
GNSS OPTION menu (SER04)	✓	P
CW IN/OUT	N	P
12G OPTION menu (SER02)	Y	P
USER PATTERN (INT1 to INT8)	Y (*1)	Y (*1)
ID CHARACTER (INT_1 to INT_4)	Y	Y
LOGO (INT_1 to INT_4)	Y	Y
PTP OPTION menu (SER03)	Y	P
SYSTEM menu	Y	Y

\*1 SER02 user pattern specifies whether power on load will be performed when the user pattern is transferred from the storage memory to the display memory. If power on load is not specified, a fixed pattern (100% color bar) is output.

## 7.2 Attaching the Cover Inlet Stopper

A cover/inlet stopper is included with the LT 4610. Use this device to prevent the power cord from being pulled free of the AC inlet. To attach the cover/inlet stopper, follow the procedure below.

- Installation

1. Cover the power cord with the cover/inlet stopper.

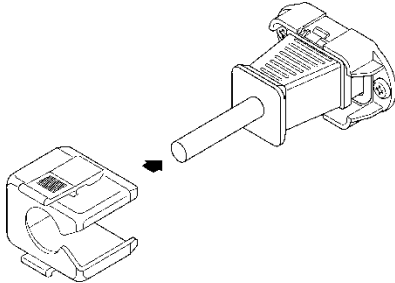

2. Push the cover/inlet stopper, until you hear a click, to attach it to the AC inlet.

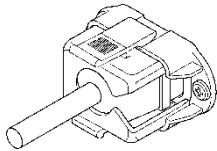

3. Check that the cover/inlet stopper is securely attached to the AC inlet.

- Removing the Cover/Inlet Stopper

1. Release the lock by using two fingers to press the cover/inlet stopper levers.

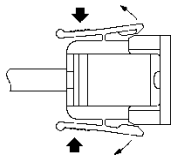

2. Pull the cover/inlet stopper away from the AC inlet.

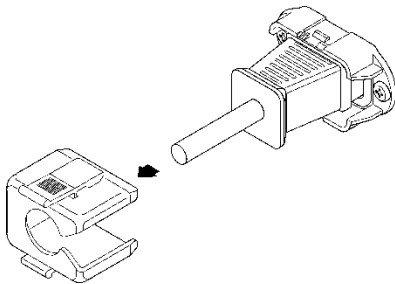

### 7.3 Alarm Indications

If an alarm occurs, the ALARM indicator on the front panel blinks in red.

If an attention state occurs, the ALARM indicator on the front panel blinks in orange.

(If an alarm and attention state occur simultaneously, the alarm takes precedence, and the indicator blinks in red.)

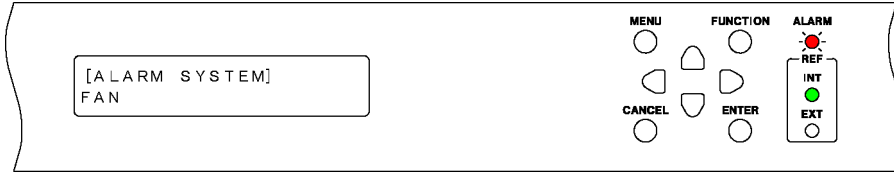

You can check the alarm details with ALARM SYSTEM or ALARM SIGNAL(SER01/SER04) on the STATUS menu. See 8.3, "Alarm Display."



You can check the attention details with ATTENTION GPS (\*1) SAT(SER01/SER04) or ATTENTION(SER01/SER04) on the STATUS menu. See 8.4, "Attention Display (SER01/SER04)."



\*1 When SER04 is installed, the satellite selected in the GENLOCK menu is displayed.

### 7.4 Connecting a USB Memory Device

To write and read various types of data, you can use a USB memory device.

You can connect and disconnect a USB memory device with the power turned on.

When you connect a USB memory device, the following message appears.

Do not turn the power off or remove the USB memory device while it is being accessed.



When you remove the USB memory device, the following message appears.



## 7.5 Installing the SFP / SFP+ Transceiver Module (SER03)

If the SER03 is installed, the rear panel has an SFP/SFP+ Port. Install SFP or SFP+ modules sold separately.

You can connect and disconnect an SFP/SFP+ transceiver module with the power turned on. To install it, follow the procedure below.

- Installation

1. Pay attention to the orientation of the SFP/SFP+ module, and insert the module into SFP/SFP+ Port.
2. Push it in until a click is heard.

SFP module

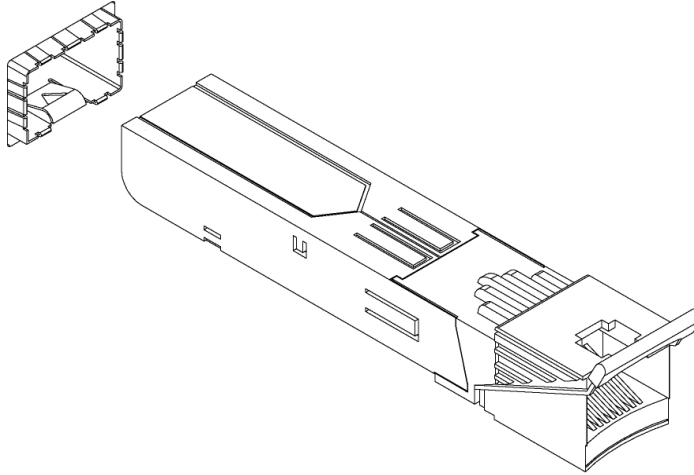

SFP+ module

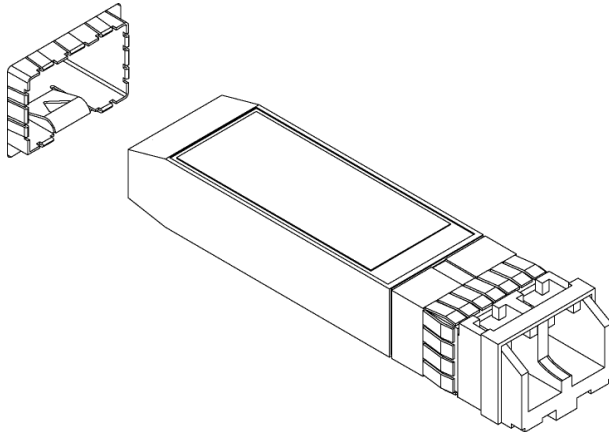

- Uninstallation

Pinch the SFP/SFP+ transceiver module with your fingers, and pull it out. Do not pull the cable.

## 7.6 Signal I/O

## 7.6.1 Analog Video Sync Signal Output

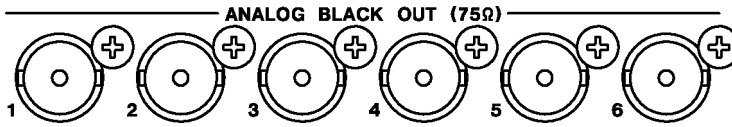

- LT 4610

Six analog video sync signals synchronized to the reference signal are output from the ANALOG BLACK OUT 1 to 6 connectors on the rear panel.

You can set the output signals on the BLACK menu.

[See also] 11, "BLACK Menu"

- LT 4611

Three analog video sync signals synchronized to the reference signal are output from the ANALOG BLACK OUT 1 to 3 connectors on the rear panel. If the SER21 is installed, three analog video sync signals synchronized to the reference signal are also output from the ANALOG BLACK OUT 4 to 6 connectors.

You can set the output signals on the BLACK menu.

[See also] 11, "BLACK Menu"

## 7.6.2 SDI Signal Output

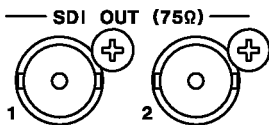

- LT 4610

Two SDI signals synchronized to the reference signal are output from the SDI OUT connectors on the rear panel.

You can set the output signals on the SDI menu.

[See also] 12, "SDI Menu"

- LT 4611

If the SER22 is installed, two SDI signals synchronized to the reference signal are output from the SDI OUT connectors on the rear panel.

You can set the output signals on the SDI menu.

[See also] 12, "SDI Menu"

## 7.6.3 AES/EBU Signal Output

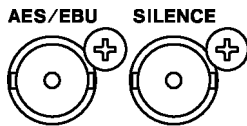

- LT 4610

An AES/EBU signal synchronized to the reference signal is output from the AES/EBU connector on the rear panel. In addition, a muted AES/EBU signal is output from the SILENCE connector.

You can set the output signals on the AES/EBU menu.

[See also] 13, "AES/EBU Menu"

- LT 4611

If the SER23 is installed, an AES/EBU signal synchronized to the reference signal is output from the AES/EBU connector on the rear panel. In addition, a muted AES/EBU signal is output from the SILENCE connector.

You can set the output signals on the AES/EBU menu.

[See also] 13, "AES/EBU Menu"

## 7.6.4 Word-Clock Signal Output

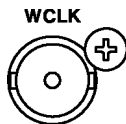

A word-clock signal synchronized to the reference signal is output from the WCLK connector on the rear panel.

You can set the output signals on the WCLK menu.

[See also] 14, "WCLK MENU"

## 7. BASIC OPERATION

### 7.6.5 Genlock Signal Input

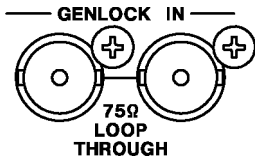

The GENLOCK IN connector on the rear panel receives HD tri-level sync or NTSC/PAL black burst signals as a genlock reference signal.

You can set the genlock on the GENLOCK menu.

In addition, it is possible to retrieve VITC from the genlock signal.

[See also] 10, "GENLOCK MENU"

Apply the genlock signal using one of the following methods.

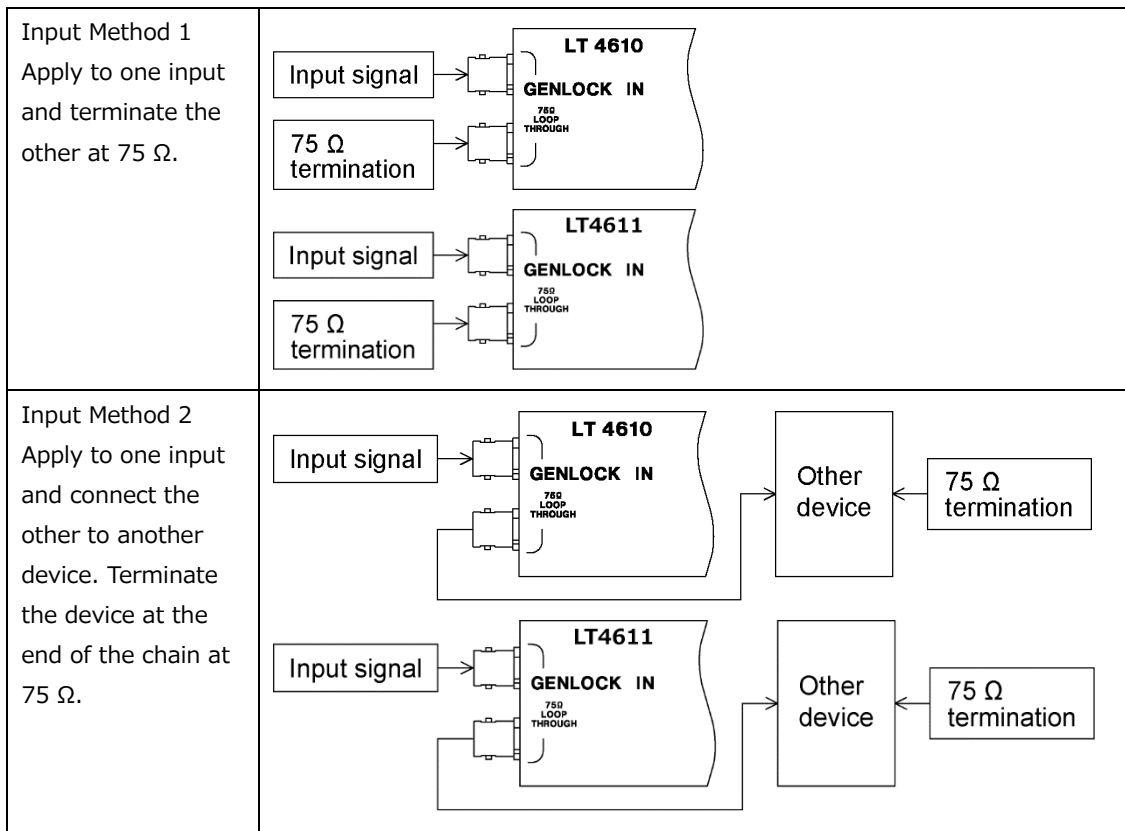

### 7.6.6 GPS Signal Input (SER01)



The GPS IN connector on the rear panel receives GPS antenna signals as a genlock reference signal.

You can set the genlock on the GENLOCK menu.

In addition, it is possible to insert time codes acquired from the GPS signal into black, SDI, or AES/EBU signals and output the time codes from the LTC IN/OUT connector on the rear panel.

[See also] 10, "GENLOCK MENU"



## 7. BASIC OPERATION

### 7.6.7 GNSS Signal Input (SER04)



The GNSS IN connector on the rear panel receives GNSS antenna signals as a genlock reference signal.

You can set the genlock on the GENLOCK menu.

In addition, it is possible to insert time codes acquired from the GNSS signal into black, SDI, or AES/EBU signals and output the time codes from the LTC IN/OUT connector on the rear panel.

[See also] 10, "GENLOCK MENU"

### 7.6.8 CW Signal I/O (SER01/SER04)

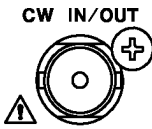

CW IN/OUT on the rear panel is used by switching between input and output according to 16.1.7, "Selecting Input or Output."

When set to input, the connector receives 10 MHz CW signals as a genlock reference signal.

You can set the genlock on the GENLOCK menu.

[See also] 10, "GENLOCK MENU"

When set to output, the connector outputs 10 MHz CW or 1PPS signals.

[See also] 16.1.8, "Selecting the Output Frequency"

### 7.6.9 LTC Signal I/O (SER01/SER04)

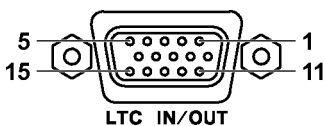

Pin No.	Pin Name	I/O
1	LTC0+	I
2	LTC1+	O
3	LTC2+	O
4	LTC3+	O
5	GND	-

Pin No.	Pin Name	I/O
6	GND	-
7	LTC0-	I
8	LTC1-	O
9	LTC2-	O
10	LTC3-	O

Pin No.	Pin Name	I/O
11	SHIELD GND	-
12	ALARM1	O
13	ALARM2	O
14	OPEN	-
15	SHIELD GND	-

The LTC IN/OUT connector on the rear panel sends and receives time codes and outputs alarms. On the LT 4610, input time codes are called LTC0 and output time codes LTC1 to LTC3.

## 7. BASIC OPERATION

- Time Code I/O

It is possible to insert time codes received through LTC0 into black, SDI, or AES/EBU signals and output the time codes from the LTC1 to LTC3 connectors on the rear panel. The time code input to LTC0 must be synchronized with the clock selected in the genlock mode on the LT 4610.

The LTC1 to LTC3 connectors output time codes synchronized to analog black signal 1. For the time code, you can select internal time, time codes retrieved from the GPS signal (SER01) or GPS/BDS signal (SER04), time codes received through LTC0, or VITC retrieved from the genlock signal.

[See also] 16, "GPS OPTION MENU (SER01)" or 17, "GNSS OPTION MENU (SER04)"

- Alarm output

If any of the alarms that are enabled according to 21.9.2, "Turing Alarm Output On and Off" occur, a 5 V CMOS signal is output from ALARM1 or ALARM2. (The polarity can be inverted.)

Alarm	Alarm condition
POWER1	When power to AC INPUT 2 is on but power to AC INPUT 1 is off.
POWER2	When power to AC INPUT 1 is on but power to AC INPUT 2 is off.
FAN	When a fan error occurs
GENLOCK NO SIGNAL	When the genlock status becomes NO SIGNAL
GENLOCK ST IN SYNC	When the genlock status becomes STAY IN SYNC
GPS ANNTENA	When ANTENNA POWER is set to 3.3V or 5V and a short circuit occurs (*3)
GPS PLL	When the genlock mode is set to GPS and the internal PLL is unlocked (*3)
GPS SIGNAL	When the LT 4610 is configured to use GPS signals>(*1) but GPS signals are not being received (*3)
CW SIGNAL	When the genlock mode is set to 10MHzCW and CW signals are not being received.
LTC0 SIGNAL	When TIMECODE SOURCE is set to LTC0 but LTC signals are not being received
VITC SIGNAL	When TIMECODE SOURCE is set to VITC but VITC signals are not being received
PTP1 PORT STATUS	When not locked in PTP master settings. (*2)
PTP2 PORT STATUS	When not locked in PTP master settings. (*2)
PTP1 LOCK	When not locked to the master PTP in PTP slave settings. (*2)
PTP2 LOCK	When not locked to the master PTP in PTP slave settings. (*2)
ATTENTION	When a GPS or time code attention occurs

\*1 This signifies the setting in which any of the following is set to GPS.

- GENLOCK MODE on the GENLOCK menu
- DATE&TIME SOURCE on the SYSTEM menu
- TIMECODE SOURCE on the SYSTEM menu

\*2 When the SER03 is installed.

\*3 When SER04 is installed, GPS is GNSS.

7.6.10 12G-SDI Signal Output (SER02)

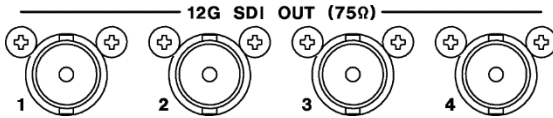

Four SDI signals are output from the rear panel.

This option supports 12G-SDI, 3G-SDI (level A and level B), HD-SDI (including dual link), and SD-SDI.

You can set the output signals on the 12G OPTION menu.

[See also] 17, "12G OPTION Menu (SER02)"

7.6.11 PTP port (SER03)

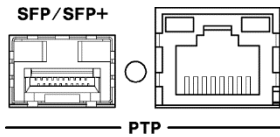

This port supports PTP (IEEE 1588).

It provides an RJ-45 port and SFP/SFP+ port. The SFP/SFP+ port is used by connecting a separately sold LC2141 SFP RJ-45, LC2144 SFP+ MULTI-MODE, or LC2145 SFP+ SINGLE MODE.

You can set PTP settings on the PTP OPTION menu.

[See also] 20, "PTP OPTION MENU (SER03)"

## 7.7 Menu Operations

There are 13 main types (including options) of menus. The menu switches in order each time you press the MENU key and in reverse order each time you press the  key. (When the menu level is zero)

No.	Menu	Description	Reference
1	STATUS menu [STATUS] ▼ GENLOCK	Displays the LT 4610 status.	Chapter 8
2	INFO menu [INFO] ▼ GENLOCK	Displays the settings entered in the LT 4610.	Chapter 9
3	GENLOCK menu 0. GENLOCK ▼ MODE	Set the genlock.	Chapter 10
4	BLACK menu 0. BLACK ▼ BLK 1	Set the black signal.	Chapter 11
5	SDI menu 0. SDI ▼ SDI 1	Set the SDI signal.	Chapter 12
6	AES/EBU menu 0. AES/EBU ▼ AES/EBU	Set the AES/EBU signal.	Chapter 13
7	WCLK menu 0. WCLK TIMING	Set the word-clock signal.	Chapter 14
8	ETC menu 0. ETC LIPSYNC	Set the lip sync function.	Chapter 15
9	GPS OPTION menu 0. GPS OPTION ▼ LTC	Set the GPS signal.	Chapter 16
10	GNSS OPTION menu 0. GNSS OPTION ▼ LTC	Set the GNSS signal.	Chapter 17
11	PTP OPTION menu 0. PTP OPTION ▼ PTP 1	Configure the PTP settings.	Chapter 19
12	12G OPTION menu 0. 12G OPTION ▼ SDI 1	Set the 12G-SDI signal.	Chapter 18
13	SYSTEM menu 0. SYSTEM ▼ LCD BACKLIGHT	Configure the LT 4610 settings.	Chapter 21

## 7. BASIC OPERATION

- Menu Levels

With some exceptions, the setting menus show a number in the upper left of the screen. This number indicates the menu level. The larger the number, the deeper the level. To enter a lower level menu, press ENTER. To return to a higher level menu, press MENU or CANCEL. Pressing MENU once causes the menu to return to a higher level. In contrast, pressing CANCEL once causes the top menu item in the same level to be selected, and pressing it again causes the menu to return to a higher level.

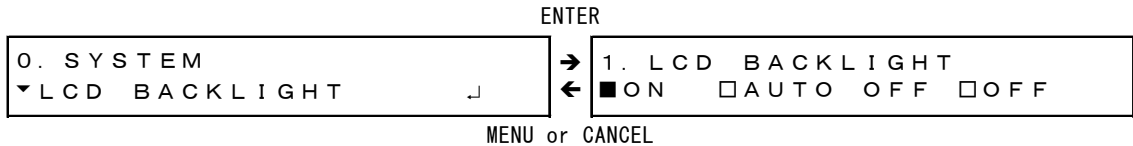

- Specifying Values

To specify values, use the ◀ and ▶ keys to move the cursor and the ▲ and ▼ keys to change the value. Hold down a key to change the value quickly.

Value modifications are applied immediately, but the value is not confirmed until you press the ENTER key.



- Selecting Items

To select an item, use the ◀ and ▶ keys. An asterisk is attached to the currently selected value.

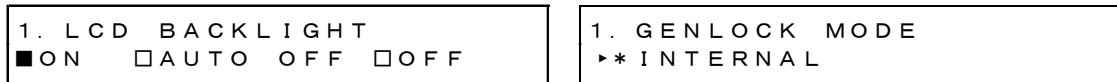

If a cursor (\*) is displayed, use the ◀ and ▶ keys to move the cursor, the ▲ key to select on, and the ▼ key to select off.



To select a setting from multiple menus, use the ▲ and ▼ keys to select the menu, and then the ◀ and ▶ keys to select the item.

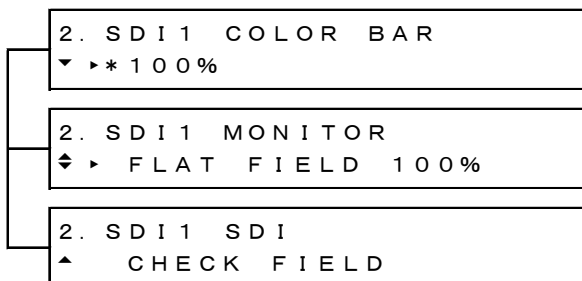

- Confirming and Canceling Settings

On a setting menu, press ENTER to confirm the setting.

Pressing MENU cancels the setting and returns to the higher level menu.

Pressing CANCEL returns the setting to its original value.

### 7.8 Genlock Operation

Genlock refers to the act of establishing synchronization using an external reference signal. Here, the procedure is explained separately for seven different modes.

Genlock mode	Reference signal	Description
Internal mode	Internal	The internal reference signal is used. The factory default setting is this mode.
Auto format mode	External (HD tri-level sync signal or NTSC/PAL black burst signal)	An external reference signal received through GENLOCK IN on the rear panel is used. The LT 4610 automatically selects the reference signal format.
Manual format mode	External (HD tri-level sync signal or NTSC/PAL black burst signal)	An external reference signal received through GENLOCK IN on the rear panel is used. Set the reference signal format manually.
GPS mode (SER01)	External (GPS signal)	A GPS reference signal received through GPS IN on the rear panel is used.
GNSS mode (SER04)	External (GNSS signal)	A GPS reference signal received through GNSS IN on the rear panel is used.
CW mode (SER01/SER04)	External (10 MHz CW signal)	An external reference signal received through CW IN/OUT on the rear panel is used.
PTP mode (SER03)	External (PTP signal)	An external reference signal received through PTP on the rear panel is used.

#### 7.8.1 Internal Mode

1. On the GENLOCK menu, set GENLOCK MODE to INTERNAL.

[See also] 10.1, "Selecting the Genlock Mode"



Under GENLOCK on the STATUS menu, INTERNAL appears, and INT on the front panel lights in green. In this state, you can begin using the instrument.

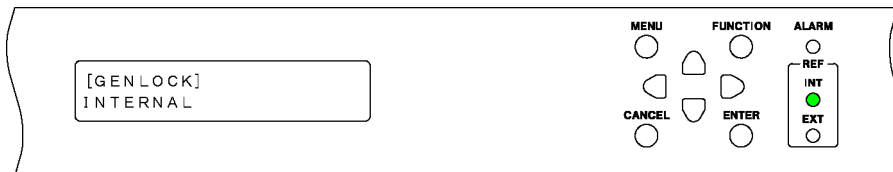

## 7. BASIC OPERATION

### 7.8.2 Auto Format Mode

1. On the GENLOCK menu, set GENLOCK MODE to GL FMT-AUTO.

[See also] 10.1, "Selecting the Genlock Mode"

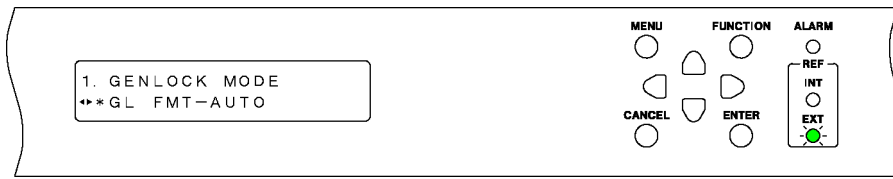

2. Apply a reference signal to GENLOCK IN on the rear panel.

Apply an HD tri-level sync or NTSC/PAL black burst signal.

[See also] 7.6.5, "Genlock Signal Input"

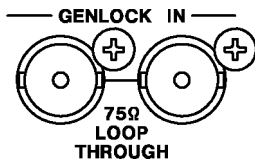

When you apply the reference signal, TRACKING appears under GENLOCK on the STATUS menu, and EXT on the front panel blinks slowly in green. This indicates that the reference signal is being drawn in.



When the LT4610 locks onto the signal, LOCKED appears under GENLOCK on the STATUS menu, and EXT on the front panel lights in green. In this state, you can begin using the instrument.



## 7. BASIC OPERATION

If an error occurs in the reference signal, the frequency that was in use immediately before the error occurred is maintained (stay-in-sync function).

Under GENLOCK on the STATUS menu, STAY IN SYNC appears, and EXT on the front panel blinks in red.

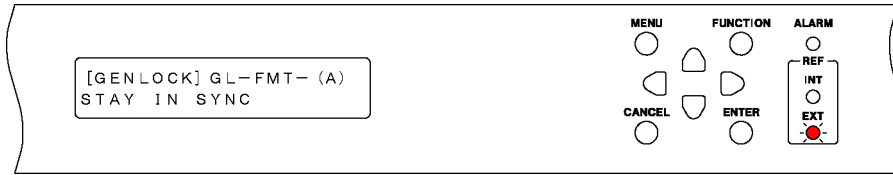

The operation that takes place when the reference signal recovers varies depending on the RECOVERY MODE setting on the GENLOCK menu.

If RECOVERY MODE is set to AUTO, the LT 4610 automatically locks when the reference signal recovers.

If RECOVERY MODE is set to MANUAL, the LT 4610 does not lock automatically even when the reference signal recovers. In this situation, you can lock onto the signal by setting GENLOCK RESET on the GENLOCK menu to OK. While relocking, all output signals are output.

[See also] 10.5, "Setting the Recovery Operation"





7.8.3 Manual Format Mode

1. On the GENLOCK menu, set GENLOCK MODE to GL FMT-MANUAL.

[See also] 10.1, "Selecting the Genlock Mode"

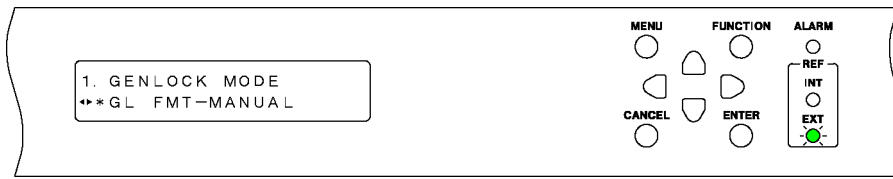

2. Set FORMAT on the GENLOCK menu.

Select the format of the reference signal that will be applied to GENLOCK IN on the rear panel.

[See also] 10.3, "Selecting the Genlock Format"

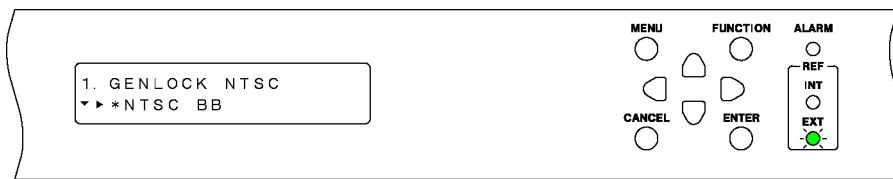

3. Apply a reference signal to GENLOCK IN on the rear panel.

Apply an HD tri-level sync or NTSC/PAL black burst signal.

[See also] 7.6.5, "Genlock Signal Input"

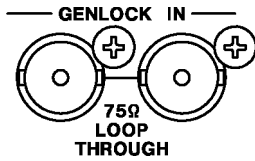

When you apply the reference signal, TRACKING appears under GENLOCK on the STATUS menu, and EXT on the front panel blinks slowly in green. The procedure from this point is the same as in 7.8.2, "Auto Format Mode."

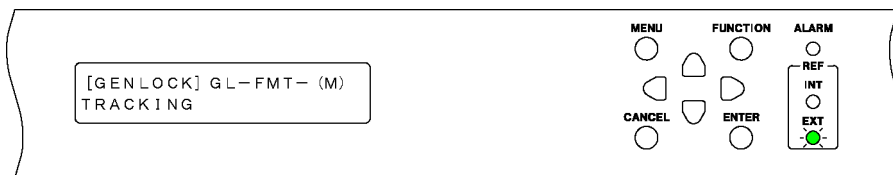

7.8.4 GPS Mode (SER01)

1. On the GENLOCK menu, set GENLOCK MODE to GPS.

If a GPS alarm, PLL alarm, GPS attention, or leap second attention state occurs, the ALARM indicator on the front panel blinks in red.

[See also] 10.1, "Selecting the Genlock Mode"

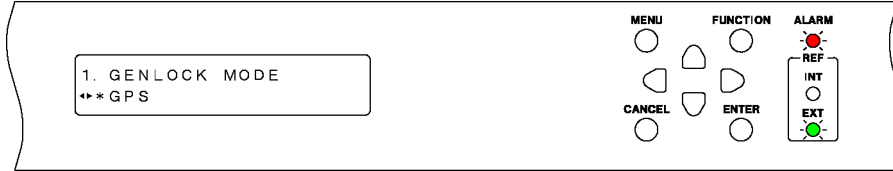

2. Apply a GPS antenna signal to GPS IN on the rear panel.

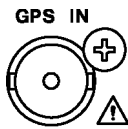

When you apply the GPS antenna signal, the GPS alarm and attention disappear, and under GENLOCK on the STATUS menu, an asterisk appears next to GPS.

ALARM indicator on the front panel keeps blinking in red or orange until the PLL alarm and leap second attention disappear. (It may take up to 12 minutes for the leap second attention to disappear after applying the GPS signal.)



When the PLL alarm and leap second attention disappear, TRACKING appears under GENLOCK on the STATUS menu, and EXT on the front panel blinks slowly in green. The procedure from this point is the same as in 7.8.2, "Auto Format Mode."



7.8.5 GNSS Mode (SER04)

1. On the GENLOCK menu, set GENLOCK MODE to GNSS.

If a GNSS alarm, PLL alarm, GNSS attention, or leap second attention state occurs, the ALARM indicator on the front panel blinks in red.

[See also] 10.1, "Selecting the Genlock Mode"

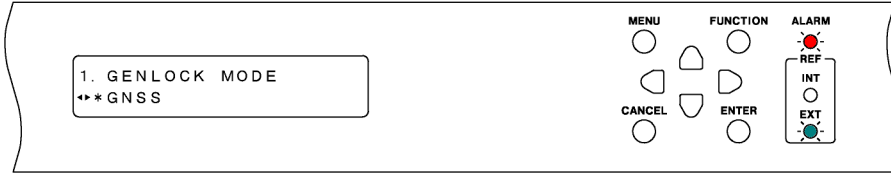

2. Apply a GNSS antenna signal to GNSS IN on the rear panel.



When you apply the GNSS antenna signal, the GNSS alarm and attention disappear, and under GENLOCK on the STATUS menu, an asterisk appears next to the satellite selected by SATELLITE.

[See also] 10.2, "Selecting the Satellite (SER04)"

ALARM indicator on the front panel keeps blinking in red or orange until the PLL alarm and leap second attention disappear. (It may take up to 12 minutes for the leap second attention to disappear after applying the GPS signal.)



When the PLL alarm and leap second attention disappear, TRACKING appears under GENLOCK on the STATUS menu, and EXT on the front panel blinks slowly in green. The procedure from this point is the same as in 7.8.2, "Auto Format Mode."



7.8.6 CW Mode (SER01/SER04)

1. On the GENLOCK menu, set GENLOCK MODE to 10MHzCW.

A 10MHzCW alarm occurs, and the ALARM indicator on the front panel blinks in red.

[See also] 10.1, "Selecting the Genlock Mode"

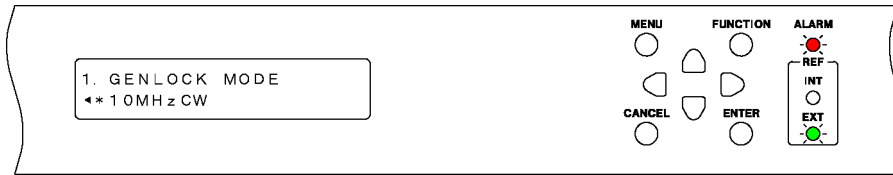

2. Set CW IN/OUT on the GPS OPTION menu (SER01) or GNSS OPTION menu (SER04) to INPUT.

[See also] 16.1.7, "Selecting Input or Output"

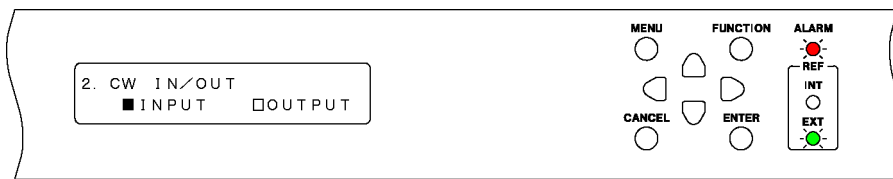

3. Apply a 10MHz CW signal to CW IN/OUT on the rear panel.

To avoid damaging the instrument, do not apply a 10 MHz CW signal when OUTPUT is selected in step 2.

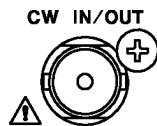

When you apply the 10 MHz CW signal, TRACKING appears under GENLOCK on the STATUS menu, and EXT on the front panel blinks slowly in green. The procedure from this point is the same as in 7.8.2, "Auto Format Mode."



## 7. BASIC OPERATION

### 7.8.7 PTP Mode (SER03)

1. On the GENLOCK menu, set GENLOCK MODE to PTP.

The ALARM indicator on the front panel blinks in red.

[See also] 10.1, "Selecting the Genlock Mode"

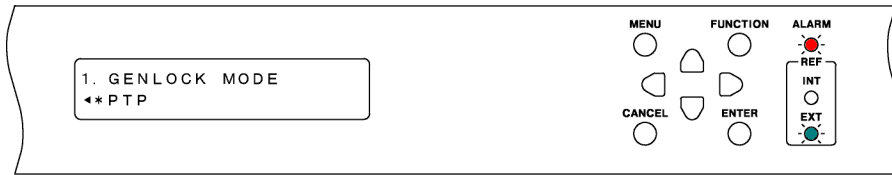

2. Attach an SFP or SFP+ transceiver to the PTP RJ45 port or the SFP/SFP+ port on the rear panel, and receive PTP packets.

When PTP packets are received, frequency adjustment is performed followed by phase adjustment. During this period, the ALARM indicator on the front panel blinks in red.



3. After the phase adjustment, time information is received. During this period, the ALARM indicator on the front panel blinks in orange.



4. When time information is successfully received, TRACKING appears under GENLOCK on the STATUS menu, and EXT on the front panel blinks slowly in green. The procedure from this point is the same as in 7.8.2, "Auto Format Mode."



## 8. STATUS MENU

The STATUS menu shows the LT 4610 status. This menu is only for viewing; you cannot change the settings.

To display the STATUS menu, press MENU several times until the following menu appears.



On the STATUS menu, you can use the ▲ and ▼ keys to switch the menu even when you are in a lower level menu.

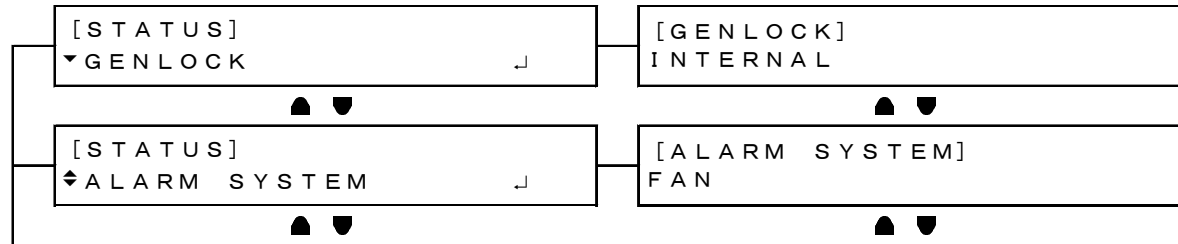

## 8. STATUS MENU

### 8.1 Genlock Status Display

The GENLOCK item displays the genlock status.

This section will explain the display details in conjunction with the front panel REF display.

Genlock mode	Menu example	Reference display	Description	
INTERNAL	[GENLOCK] INTERNAL	REF INT ● EXT ○	[INT] Lit in green	
GL FMT-AUTO GL FMT-MANUAL GPS (SER01) GNSS (SER04) 10MHzCW (SER01/SER04)	[GENLOCK] GL-FMT- (A) NO SIGNAL	REF INT ○ EXT ●	[EXT] Blinking green (fast)	When the input signal cannot be detected
	[GENLOCK] GL-FMT- (A) TRACKING	REF INT ○ EXT ●	[EXT] Blinking green (slow)	Tracking
	[GENLOCK] GL-FMT- (A) LOCKED	REF INT ○ EXT ●	[EXT] Lit in green	Locked
	[GENLOCK] GL-FMT- (A) STAY IN SYNC	REF INT ○ EXT ●	[EXT] Blinking red	When the reference signal cannot be detected correctly (Stay-in-sync)
PTP (SER03)	[GENLOCK] PTP NO SIGNAL	REF INT ○ EXT ●	[EXT] Blinking green (fast)	When there is no input signal
	[GENLOCK] PTP TRACKING	REF INT ○ EXT ●	[EXT] Blinking green (slow)	Tracking
	[GENLOCK] PTP LOCKED	REF INT ○ EXT ●	[EXT] Lit in green	Locked
	[GENLOCK] PTP STAY IN SYNC	REF INT ○ EXT ●	[EXT] Blinking red	When an error occurs in the reference signal (Stay-in-sync)

## 8. STATUS MENU

When the genlock mode is set to GPS, an asterisk is displayed when a GPS signal is received. This is synchronized to the GPS alarm. When the asterisk is hidden, the GPS alarm is indicated, and vice versa.

[See also] 8.3, "Alarm Display"

When the genlock mode is set to GNSS, an asterisk is displayed when a GNSS signal is received. This is synchronized to the GNSS alarm. When the asterisk is hidden, the GNSS alarm is indicated, and vice versa.

[See also] 8.3, "Alarm Display"

```
[ G E N L O C K ] G P S *  
L O C K E D
```

### 8.2 Genlock Format Display

The GENLOCK FORMAT item displays the genlock format when the genlock mode is not INTERNAL.

When the genlock mode is set to GL FMT-AUTO or GL FMT-MANUAL, the format of the signal received through GENLOCK IN on the rear panel is displayed.

In either mode, if the signal is being tracked or the input signal cannot be recognized, "UNKNOWN" is displayed.

When the genlock mode is set to GPS(SER01), GNSS(SER04) or 10MHzCW(SER01/SER04), the format of Black 1 selected in 11.1, "Selecting the Black Format," is displayed.

```
[ G E N L O C K   F O R M A T ]  
N T S C   B B
```



### 8.3 Alarm Display

There are two types of alarm displays: one dealing with the LT 4610 and the other dealing with the signal. If an alarm occurs, the ALARM indicator on the front panel blinks in red. However, if a PWR1 or PWR2 alarm occurs, the ALARM indicator does not turn on. Instead POWER 1 or POWER 2 lights in red.

- Alarm display related to the LT 4610

ALARM SYSTEM shows alarms related to the LT 4610.

[ A L A R M   S Y S T E M ] F A N
--------------------------------------

The following table lists the alarms related to the LT 4610.

Alarm	Display condition	Corrective action
FAN	When a fan error occurs	Contact your nearest LEADER agent.
PWR1	When power to AC INPUT 2 is on but power to AC INPUT 1 is off.	If this alarm appears even when power to AC INPUT 1 is turned on, contact your nearest LEADER agent.
PWR2	When power to AC INPUT 1 is on but power to AC INPUT 2 is off.	If this alarm appears even when power to AC INPUT 2 is turned on, contact your nearest LEADER agent.
ANT.	When ANTENNA POWER on the SYSTEM menu is set to 3.3V or 5V and a short circuit occurs (SER01/SER04)	Check the GPS (SER01) or GNSS (SER04) antenna.

- Alarm display related to signals (SER01/SER03/SER04)

ALARM SIGNAL shows alarms related to signals.

[ A L A R M   S I G N A L ] G P S
--------------------------------------

## 8. STATUS MENU

The following table lists the alarms related to signals.

Alarm	Display condition	Corrective action
PLL	When the genlock mode is set to GPS or GNSS and the internal PLL is unlocked	Contact your nearest LEADER agent.
GPS	When the LT 4610 is configured to use GPS signals,(*1, *2) but GPS signals are not being received	Check that GPS signals are being applied to GPS IN / GNSS IN on the rear panel.
BDS	When the LT 4610 is configured to use GNSS signals,( *2) but BDS signals are not being received	Check that BDS signals are being applied to GNSS IN on the rear panel.
10MHzCW	When the genlock mode is set to 10MHzCW and CW signals are not being received.	Check that 10 MHz CW signals are being applied to CW IN/OUT on the rear panel.
LTC0	When TIMECODE SOURCE on the SYSTEM menu is set to LTC0 but LTC signals are not being received	Check that LTC signals are being applied to LTC IN/OUT on the rear panel.
VITC	When TIMECODE SOURCE on the SYSTEM menu is set to VITC but VITC signals are not being received	Check that VITC signals are being applied to GENLOCK IN on the rear panel.
PTP STRTING UP (SER03)	When the genlock mode is set to PTP or TIMESOURCE is set to PTP, about 5 minutes after startup is the preparation period for stable operation.	It disappears automatically when the preparation period ends. The preparation period is about 5 minutes.
PTPx Restart (SER03)	When the genlock source is switched or the preset is recalled, the PTP function restarts and "PTPx Restart" is displayed.	It disappears automatically when the restart is completed.
PTPx PLL measuring (SER03)	When PTP is adjusting the frequency and phase with the time source.	When the adjustment is completed, it disappears automatically.
ADJUST FREQ (SER03)	When the genlock mode is PTP and the frequency is adjusting to the received PTP packet.	If it continues to be displayed, check the settings for each message interval with the PTP master.
ADJUST PHASE (SER03)	When the genlock mode is PTP and the phase is adjusting to the received PTP packet.	If it continues to be displayed, check the settings for each message interval with the PTP master.
PTP SLV UNLOCK (SER03)	When the genlock mode is set to GL FMT-AUTO or GL FMT-MANUAL and TIMECODE SOURCE is set to PTP, and the PTP master is not recognized or is being adjusted.	It disappears automatically when the adjustment is completed. If the display does not disappear, check the connection with the PTP master and the PTP settings.
PTP ClockClass (SER03)	When the genlock mode is set to GL FMT-AUTO or GL FMT-MANUAL and TIMECODE SOURCE is set to PTP, and the PTP master is Self-propelled.	It disappears automatically when the self-propelled state of the PTP master is released.

## 8. STATUS MENU

- \*1 This signifies the setting in which any of the following is set to GPS.
  - GENLOCK MODE on the GENLOCK menu
  - DATE&TIME SOURCE on the SYSTEM menu
  - TIMECODE SOURCE on the SYSTEM menu
- \*2 This signifies the setting in which any of the following is set to GNSS.
  - GENLOCK MODE on the GENLOCK menu
  - DATE&TIME SOURCE on the SYSTEM menu
  - TIMECODE SOURCE on the SYSTEM menu

## 8.4 Attention Display (SER01/SER04)

There are two types of attention displays: one dealing with the GPS and the other dealing with the time code. If an attention state occurs, the ALARM indicator on the front panel blinks in orange.

- Attention display related to GPS

The ATTENTION GPS (\*1) SAT menu appears when the LT 4610 is configured to use GPS (\*2), or GNSS (\*3) signals, and the number of used satellites is 2 or less or if the maximum CN value is 15 dB or less.

```
[ATTENTION GPS SAT]
SAT-NUM 2, CN 15 dB
```

- Attention display related to time codes

The ATTENTION item displays attention states related to time codes.

```
[ATTENTION]
LEAP-SECOND
```

The following table lists the attention states related to time codes.

Attention	Display condition
LEAP-SECOND	When the LT 4610 is configured to use GPS/BDS signals, (*2)(*3) but leap second information cannot be received (It may take up to 12 minutes for the leap second information to be received after applying the GPS/BDS signal.)
CLOCK	While settings are being changed when TIMECODE SOURCE is set to INTERNAL and DATE&TIME SOURCE is set to GPS/GNSS (It will take some time for the LT 4610 to be able to use the time codes retrieved from the GPS/BDS signal after the settings have been changed.)

\*1 When SER04 is installed, the satellite selected in the GENLOCK menu is displayed.

\*2 This signifies the setting in which any of the following is set to GPS.

- GENLOCK MODE on the GENLOCK menu
- DATE&TIME SOURCE on the SYSTEM menu
- TIMECODE SOURCE on the SYSTEM menu

\*3 This signifies the setting in which any of the following is set to GNSS.

- GENLOCK MODE on the GENLOCK menu
- DATE&TIME SOURCE on the SYSTEM menu
- TIMECODE SOURCE on the SYSTEM menu

## 8.5 Satellite Count Display (SER01/SER04)

The SATELLITE NUMBER item displays the number of GPS or GNSS satellites.

The numerator indicates the number of satellites in the line of view, and the denominator the number of satellite that the LT 4610 can use.

```
[SATELLITE NUMBER]
8 / 11
```

## 8. STATUS MENU

### 8.6 CN Display (SER01/SER04)

The GPS (\*1) CN item displays the CN of the GPS or BDS signal.

Of the satellites that the LT 4610 can use, MIN shows the minimum CN value and MAX the maximum value.

\*1 When SER04 is installed, the satellite selected in the GENLOCK menu is displayed.

```
[GPS CN]
MIN: 15 MAX: 35 [dB]
```

### 8.7 PTP Attention Display (SER03)

When PTP1 or PTP2 is set to MASTER, the attentions states are displayed. If a PTP attention state occurs, the ALARM indicator on the front panel blinks in orange.

Display example	ALARM LED display	Description
<pre>[ATTENTION PTPx] PTP PLL ADJUST</pre>	Blinking orange	PLL adjustment in progress
<pre>[ATTENTION PTPx] TIME SETTING</pre>	Blinking orange	Time setting in progress

\* PTPx in the display examples is either PTP1 or PTP2.

### 8.8 PTP MASTER ID Display (SER03)

When the GENLOCK mode is PTP, the PTP master ID is displayed when locked to PTP master.

```
[PTP MASTER ID]
XXXXXXXXXXXXXXXXXXXX
```

### 8.9 PTP PHASE Display (SER03)

When the GENLOCK mode is PTP, the time difference from the PTP master is displayed when locked to PTP master.

```
[PTP PHASE]
-15.278ns
```

### 8.10 UTC Display (SER01/SER04)

The UTC TIME item displays the Coordinated Universal Time retrieved from the GPS/BDS signal.

```
[UTC TIME]
2018/04/01 12:34:56
```

## 8. STATUS MENU

### 8.11 Local Time Display (SER01/SER04)

The LOCAL TIME item displays the time code selected in 21.7.1, "Selecting the Time Code."

```
[LOCAL TIME]
2018/04/01 12:34:56
```

### 8.12 Internal Clock Display

The INTERNAL CLOCK item displays the internal clock selected in 21.6.1, "Selecting the Date and Time."

```
[INTERNAL CLOCK]
2018/04/01 12:34:56
```

## 9. INFO MENU

The INFO item displays the settings entered in the LT 4610. This menu is only for viewing; you cannot change the settings.

To display the INFO menu, press MENU several times until the following menu appears.

```
[ I N F O ]
▼ G E N L O C K      ⌋
```

On the INFO menu, you can use the ▲ and ▼ keys to switch after you enter a lower level menu.

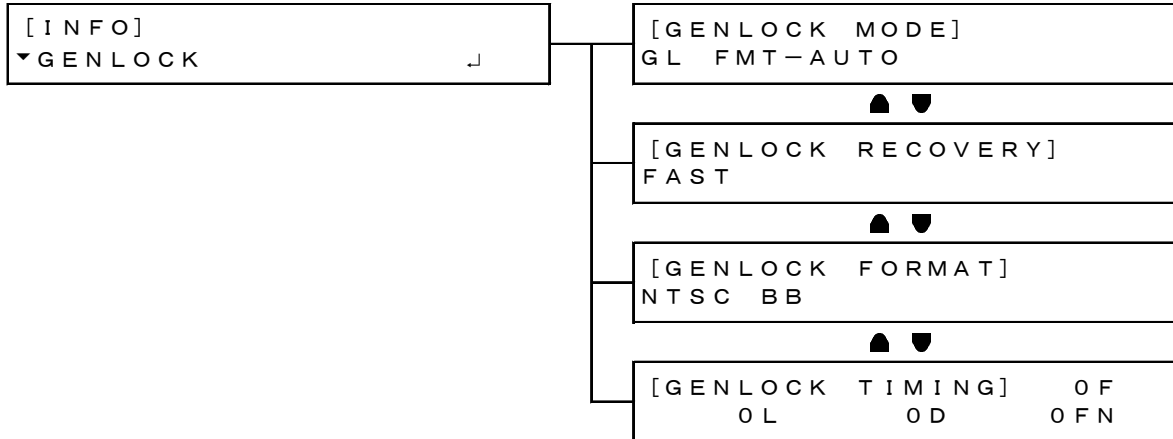

## 9.1 Genlock Setting Display

The GENLOCK item displays the items set on the GENLOCK menu.

```
[ I N F O ]
▼ G E N L O C K      ↵
```

- GENLOCK MODE

The genlock mode selected in 10.1, "Selecting the Genlock Mode," is displayed.

```
[ G E N L O C K   M O D E ]
I N T E R N A L
```

- GENLOCK RECOVERY

When the genlock mode is not set to INTERNAL, the recovery mode selected in 10.5.2, "Selecting the Auto Setting," is displayed.

```
[ G E N L O C K   R E C O V E R Y ]
F A S T
```

- GENLOCK FORMAT

When the genlock mode is set to GL FMT-AUTO or GL FMT-MANUAL, the genlock format of the signal input to GENLOCK IN is displayed. When the signal format cannot be detected, UNKNOWN is displayed.

When the genlock mode is set to GPS (SER01), GNSS (SER04), or PTP (SER03), the format of the signal output to ANALOG BLACK OUT 1 is displayed.

```
[ G E N L O C K   F O R M A T ]
N T S C   B B
```

- GENLOCK TIMING

When the genlock mode is set to GL FMT-AUTO, GL FMT-MANUAL, GPS(SER01), GNSS(SER04), or PTP(SER03), the timing selected in 11.2, "Adjusting the Timing," is displayed.

```
[ G E N L O C K   T I M I N G ]      O F
      O L           O D           O F N
```



## 9.2 Black Setting Display

The BLACK item displays the items set on the BLACK menu.

```
[ I N F O ]
◆ B L A C K      ↵
```

- BLK1 FORMAT

The Black 1 format selected in 11.1, "Selecting the Black Format," is displayed.

The same holds true for BLK2 FORMAT to BLK6 FORMAT.

For the LT 4611, BLK4 FORMAT to BLK6 FORMAT is displayed when SER21 is installed.

```
[ B L K 1   F O R M A T ]
N T S C   B B
```

- BLK1 TIMING

The Black 1 timing selected in 11.2, "Adjusting the Timing," is displayed.

The same holds true for BLK2 TIMING to BLK6 TIMING.

For the LT 4611, BLK4 TIMING to BLK6 TIMING is displayed when SER21 is installed.

```
[ B L K 1   T I M I N G ]
O F           O L           O D
```

### 9.3 SDI Setting Display

The SDI item displays the items set on the SDI menu.  
For the LT 4611, it is displayed when SER22 is installed.

```
[ I N F O ]
↳ S D I      ↵
```

- SDI1 FORMAT

The SDI1 format selected in 12.1, "Setting the SDI Format," is displayed.  
The same hold true for SDI2 FORMAT.

```
[ S D I 1  F O R M A T ]
1 0 8 0 : H D      / 5 9 . 9 4 I
```

- SDI1 TIMING

The SDI1 timing selected in 11.2, "Adjusting the Timing," is displayed.  
The same hold true for SDI2 TIMING.

```
[ S D I 1  T I M I N G ]
           0 L           0 D
```

### 9.4 GPS Setting Display (SER01)

The GPS item displays the voltage supplied to the GPS antenna selected in 21.8.2, "Setting the Power Supply."

```
[ I N F O ]      [ G P S  A N T E N N A ]
↳ G P S          O F F
      ↵
```

### 9.5 GNSS Setting Display (SER04)

The GNSS item displays the voltage supplied to the GNSS antenna selected in 21.8.2, "Setting the Power Supply."

```
[ I N F O ]      [ G N S S  A N T E N N A ]
↳ G N S S        O F F
      ↵
```

## 9.6 12G Setting Display (SER02)

The 12G item displays the items set on the 12G OPTION menu.

```
[ I N F O ]
^ 1 2 G      ↵
```

- 12G 1 FORMAT

The SDI1 format is displayed.

The same applies to 12G 2 FORMAT, 12G 3 FORMAT, and 12G 4 FORMAT.

```
[ 1 2 G 1 F O R M A T ]
2 1 6 0 1 2 G / 5 9 . 9 4 P
```

- 12G 1 TIMING

The SDI1 timing is displayed.

The same applies to 12G 2 TIMING, 12G 3 TIMING, and 12G 4 TIMING.

```
[ 1 2 G 1 T I M I N G ]
           O L           O D
```

## 10. GENLOCK MENU

The GENLOCK item displays settings related to genlock operation.

To display the GENLOCK menu, press MENU several times until the following menu appears.



### 10.1 Selecting the Genlock Mode

To select the genlock mode, follow the procedure below.



#### Procedure

GENLOCK → MODE

#### Parameters

INTERNAL: The internal reference signal is used.

GL FMT-AUTO: An external reference signal received through GENLOCK IN on the rear panel is used. The LT 4610 automatically selects the format.

GL FMT-MANUAL: An external reference signal received through GENLOCK IN on the rear panel is used. The format must be set manually.

GPS: An external reference signal received through GPS IN on the rear panel is used. You can select this option when SER01 is installed.

GNSS: An external reference signal received through GNSS IN on the rear panel is used. You can select this option when SER04 is installed.

10MHzCW: An external reference signal received through CW IN/OUT on the rear panel is used. You can select this option when SER01, or SER04 is installed.

PTP: PTP1 is set to PTP slave. You can select this option when SER03 is installed.

### 10.2 Selecting the Satellite (SER04)

To select the satellite, follow the procedure below. This menu is displayed when SER04 is installed.



#### Procedure

GENLOCK → SATELLITE

#### Parameters

GPS: Select GPS.

BDS: Select BDS.

### 10.3 Selecting the Genlock Format

When the genlock mode is set to GL FMT-MANUAL, to select the genlock format, follow the procedure below. To select items use the ▲, ▼, ◀, and ▶ keys.

The genlock formats are expressed in terms of the total number of lines, not the number of effective lines.

1. GENLOCK NTSC ▼ ▶ * NTSC BB
----------------------------------

---

#### Procedure

GENLOCK → FORMAT

---

#### Parameters

---

NTSC: NTSC BB / NTSC BB+REF / NTSC BB+ID / NTSC BB+REF+ID

PAL: PAL BB / PAL BB+REF

COMPONENT: 525/59.94I / 525/59.94P / 625/50I / 625/50P

1125:HD: 1125/60I / 1125/59.94I / 1125/50I / 1125/30P / 1125/29.97P /  
 1125/25P / 1125/24P / 1125/23.98P / 1125/24PsF / 1125/23.98PsF

750:HD: 750/60P / 750/59.94P / 750/50P / 750/30P / 750/29.97P / 750/25P /  
 750/24P / 750/23.98P

---

\* REF represents the field reference pulse, and ID represents the field ID.

## 10.4 Adjusting the Timing

Under GENLOCK→TIMING, you can collectively adjust the timing of the output signals (ANALOG BLACK, SDI, AES/EBU, SILENCE, WCLK) relative to the reference signal. (You can also adjust them individually.)

This menu appears when the genlock mode is set to GL FMT-AUTO, GL FMT-MANUAL, GPS(SER01), GNSS(SER04), or PTP(SER03).

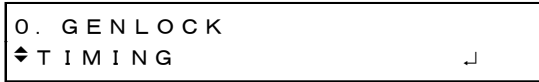

### 10.4.1 Adjusting the Timing (Frame)

To adjust the output signals relative to the reference signal at the frame level, follow the procedure below.

This menu is displayed in the following situations.

- When the genlock mode is set to GL FMT-AUTO and the format of the signal applied to GENLOCK IN on the rear panel is NTSC or PAL
- When the genlock mode is set to GL FMT-MANUAL and the format selected in 10.3, "Selecting the Genlock Format," is NTSC or PAL
- When the genlock mode is set to GPS, GNSS or PTP and the Black 1 format selected in 11.1, "Selecting the Black Format," is NTSC or PAL



#### Procedure

GENLOCK → TIMING → FRAME

#### Parameters

NTSC: -5 to 0 to +5

PAL: -2 to 0 to +2

### 10.4.2 Adjusting the Timing (Line)

To adjust the output signals relative to the reference signal at the line level, follow the procedure below.

The variable range varies depending on the format.



#### Procedure

GENLOCK → TIMING → VERTICAL

#### Parameters

-1125 to 0 to +1125

## 10.4.3 Adjusting the Timing (Dot)

To adjust the output signals relative to the reference signal at the dot level, follow the procedure below. To the right of DOT, the value obtained by converting dots into time is displayed.

The variable range varies depending on the format.

2. GENLOCK TIMING H
<u>0</u> DOT      0. 0000 $\mu$ s

Procedure

---

GENLOCK → TIMING → HORIZONTAL

---

Parameters

---

-432 to 0 to +432

---

## 10.4.4 Finely Adjusting the Timing

To finely adjust the output signals relative to the reference signal, follow the procedure below.

One step is approximately 0.5 ns and covers one dot period.

2. GENLOCK TIMING FN
FINE : <u>0</u>

Procedure

---

GENLOCK → TIMING → FINE

---

Parameters

---

-100 to 0 to +100

---

## 10.5 Setting the Recovery Operation

Under GENLOCK→RECOVERY, you can set the recovery operation that takes place when the reference signal is lost during genlock operation.

This menu appears when the genlock mode is not set to INTERNAL.



### 10.5.1 Selecting the Recovery Mode

To select the relock operation to perform when the reference signal recovers after it is lost during genlock operation, follow the procedure below.



#### Procedure

GENLOCK → RECOVERY → MODE

#### Parameters

**AUTO:** The LT 4610 quickly relocks onto the reference signal.  
**MANUAL:** Stay-in-sync operation is held.

### 10.5.2 Selecting the Auto Setting

To select the relock operation to perform when the recovery mode is set to AUTO, follow the procedure below.

When the genlock mode is GPS (SER01) or GNSS (SER04), you cannot select IMMEDIATE.



#### Procedure

GENLOCK → RECOVERY → AUTO SETTING

#### Parameters

**IMMEDIATE:** The LT 4610 immediately relocks onto the reference signal.  
**FAST:** The LT 4610 quickly relocks onto the reference signal.  
**SLOW:** The LT 4610 slowly relocks onto the reference signal.



## 10.5.3 Selecting the Manual Setting

To select the relock operation to perform when the recovery mode is set to MANUAL, follow the procedure below.

```

2. M A N U A L   S E T T I N G
▶ * I M M E D I A T E

```

---

 Procedure

GENLOCK → RECOVERY → MANUAL SETTING

---

## Parameters

IMMEDIATE: The LT 4610 immediately relocks onto the reference signal.

FAST: The LT 4610 quickly relocks onto the reference signal.

SLOW: The LT 4610 slowly relocks onto the reference signal.

---

## 10.5.4 Setting the Relock

To manually relock when the reference signal recovers after it is lost during genlock operation, select OK by following the procedure below. This setting is used when RECOVERY MODE is set to MANUAL.

```

2. G E N L O C K   R E S E T
   □ O K           ■ C A N C E L

```

---

 Procedure

GENLOCK → RECOVERY → GENLOCK RESET

---

## 10.6 Setting the Genlock Log

Under GENLOCK→LOG, you can set the genlock log.

The genlock log automatically records the changes in the genlock state in chronological order.

```
0. GENLOCK
^ LOG
```

### 10.6.1 Viewing the Log

To view the genlock log, follow the procedure below.

Press ▲ to view newer log entries, ▼ to view older log entries, and ENTER to view the details of log entries.

You can view up to 100 entries from 00 to 99. Subsequent entries that occur overwrite the oldest entries.

The date and time will be those selected in 21.6.1, "Selecting the Date and Time."

The genlock log is not cleared when the settings are initialized but is cleared when the power is turned off.

```
2. LOG LIST
00' 18/04/01 12:34:56
18/04/01 12:34:56
00:MODE [INTERNAL]
```

Procedure

---

GENLOCK → LOG → LIST

---

10.6.2 Adding DETAIL and ALARM

To turn on and off DETAIL and ALARM additions to the genlock log separately, follow the procedure below. By default, both DETAIL and ALARM are turned on.

When DETAIL is turned on, FORMAT NOT DETECT is valid, when the genlock format is analog video sync signal (NTSC BB, PAL BB, Tri-Level SYNC), such as the interruption of the analog video sync signal are detected.

When ALARM is turned on, FAN, POWER1 and POWER2 are valid, and power failure and fan stop are detected.

When the DETAIL and ALARM settings are changed, the genlock log disappears.

Move the cursor (\*) with the ◀ ▶ keys to select the item, and use the ▲ ▼ keys to switch it on and off.

2. SELECT LOG * ■ DETAIL      ■ ALARM	(DETAIL: ON, ALARM: ON)
--	-------------------------

2. SELECT LOG * □ DETAIL      □ ALARM	(DETAIL: OFF, ALARM: OFF)
--	---------------------------

2. SELECT LOG * ■ DETAIL      □ ALARM	(DETAIL: ON, ALARM: OFF)
--	--------------------------

2. SELECT LOG * □ DETAIL      ■ ALARM	(DETAIL: OFF, ALARM: ON)
--	--------------------------

Procedure

---

GENLOCK → LOG → SELECT LOG

---

Parameters

---

ON / OFF

---

10.6.3 Copying the Log to USB

To copy the genlock log in text format from the LT 4610 to a USB memory device, follow the procedure below.

This setting appears when a USB memory device is connected.



Procedure

GENLOCK → LOG → COPY INT→USB

• USB Memory Device File Structure

The genlock log is copied to the LOG folder in the USB memory device.

The date and time of the file will be those selected in 21.6.1, "Selecting the Date and Time."

- 📁 USB memory device
  - └─ 📁 LT 4610\_USER
    - └─ 📁 LOG
      - └─ 📄 YYYYMMDDhhmmss.txt

• Example of YYYYMMDDhhmmss.txt

```
00:2016/04/07 13:33:01 MODE[INTERNAL]
01:2016/04/07 13:33:01 FORMAT[NTSC BB]
02:2016/04/07 13:33:01 EPOCH[SMPTE]
03:2016/04/07 13:33:01 LOCK(NO SIGNAL)
04:2016/04/07 13:33:02 LOCK(INTERNAL)
05:2016/04/07 13:33:23 MODE[GENLOCK-FMT-AUTO]
06:2016/04/07 13:33:23 LOCK(NO SIGNAL)
07:2016/04/07 13:33:37 LOCK(TRACKING)
08:2016/04/07 13:33:46
LOCK(EXT.)[1125/59.94I]
09:2016/04/07 13:34:13 LOCK(STAY IN SYNC)
10:2016/04/07 13:34:28 LOCK(TRACKING)
11:2016/04/07 13:34:51
LOCK(EXT.)[1125/59.94I]
```

10.6.4 Clearing the Log

To clear the genlock log, select OK by following the procedure below.



Procedure

GENLOCK → LOG → DELETE

## 11. BLACK MENU

The BLACK menu is used to specify settings related to black output.

For the LT 4611, you can select Black 4 to 6 when SER21 is installed.

To display the BLACK menu, press MENU several times until the following menu appears.

```

0. B L A C K
▼ B L K 1
  
```

On the BLACK menu, you can set Black 1 to 6 separately. The procedure below is for Black 1, but the same procedure can be applied to Black 2 to 6.

### 11.1 Selecting the Black Format

To select the black signal format, follow the procedure below. To select items use the ▲, ▼, ◀, and ▶ keys.

The black formats are expressed in terms of the total number of lines, not the number of effective lines.

```

2. B L K 1  N T S C
▼ ▶ * N T S C  B B
  
```

When the genlock mode is set to GPS(SER01), GNSS(SER04), or 10MHzCW(SER01/SER04), for Black 1 only, the following message will appear if the value is changed. If OK is selected, the LT 4610 unlocks from the signal if it is locked and switches to tracking operation.

```

C H A N G E  B L K 1  F O R M A T  ?
  ■ O K           □ C A N C E L
  
```

#### Procedure

BLACK → BLK1 → FORMAT

#### Parameters

NTSC:	NTSC BB / NTSC BB+REF / NTSC BB+ID / NTSC BB+REF+ID / NTSC BB+SETUP / NTSC BB+S+REF / NTSC BB+S+ID / NTSC BB+S+R+ID
PAL:	PAL BB / PAL BB+REF
COMPONENT:	525/59.94I / 525/59.94P / 625/50I / 625/50P
1125:HD:	1125/60I / 1125/59.94I / 1125/50I / 1125/30P / 1125/29.97P / 1125/25P / 1125/24P / 1125/23.98P / 1125/24PsF / 1125/23.98PsF
750:HD:	750/60P / 750/59.94P / 750/50P / 750/30P / 750/29.97P / 750/25P / 750/24P / 750/23.98P

\* REF and R represent the field reference pulse, ID represents the field ID, and S represents setup.

\* The default value is NTSC BB when FORMAT SETTING is NTSC and PAL BB when FORMAT SETTING is PAL.

## 11.2 Adjusting the Timing

Under BLACK→BLK1→TIMING, you can adjust the black signal relative to the reference signal.

```
1. BLACK BLK1
  ^TIMING      ↵
```

### 11.2.1 Adjusting the Timing (Frame)

When the black format is set to NTSC or PAL, to adjust the black signal relative to the reference signal at the frame level, follow the procedure below.

```
3. BLK1 TIMING F
   0 FRAME
```

Procedure

---

BLACK → BLK1 → TIMING → FRAME

---

Parameters

NTSC:            -5 to 0 to +5

PAL:             -2 to 0 to +2

---

### 11.2.2 Adjusting the Timing (Line)

To adjust the black signal relative to the reference signal at the line level, follow the procedure below.

The variable range varies depending on the format.

```
3. BLK1 TIMING V
   0 LINE
```

Procedure

---

BLACK → BLK1 → TIMING → VERTICAL

---

Parameters

-1124 to 0 to +1124

---

## 11.2.3 Adjusting the Timing (Dot)

To adjust the black signal relative to the reference signal at the dot level, follow the procedure below. To the right of DOT, the value obtained by converting dots into time is displayed.

The variable range varies depending on the format.

3. BLK1 TIMING H
<u>0</u> DOT      0. 0000 $\mu$ s

Procedure

---

BLACK → BLK1 → TIMING → HORIZONTAL

---

Parameters

---

-4124 to 0 to +4124

---

## 11.3 Turing the Time Code On and Off (SER01/SER04)

When the black format is NTSC or PAL, to turn on or off the time code insertion selected in 21.7.1, "Selecting the Time Code," follow the procedure below.

Black 2 to 6 can be turned on or off when the format is the same type as Black 1 (NTSC or PAL).

2. BLK1 VITC
<input type="checkbox"/> ON <input checked="" type="checkbox"/> OFF

Procedure

---

BLACK → BLK1 → VITC

---

Parameters

---

ON / OFF

---

## 11.4 Common Black Signal Settings

You can synchronize the Black 2 settings to the Black 1 settings by following the procedure below to select ON. If you synchronize the settings, you cannot set the format or timing of Black 2 separately.

Likewise, Black 3 to 6 settings can also be synchronized to the Black 1 settings.

2. BLK2 EQUAL TO BLK1
<input checked="" type="checkbox"/> ON <input type="checkbox"/> OFF

Procedure

---

BLACK → BLK2 → EQUAL TO BLK1

---

Parameters

---

ON / OFF

---

## 12. SDI MENU

The SDI menu is used to specify settings related to SDI output.

For the LT 4611, you can select this option when SER22 is installed.

To display the SDI menu, press MENU several times until the following menu appears.



On the SDI menu, you can set SDI1 and SDI2 separately. The procedure below is for SDI1, but the same procedure can be applied to SDI2.

Note that for 3G-B or HD(DL), SDI2 cannot be set because only one output is available.

### 12.1 Setting the SDI Format

Under SDI→SDI1→FORMAT, you can set the SDI signal format.

For the available combinations of IMAGE, STRUCTURE, and RATE, see 5.1.2, "SDI Formats and Standards."

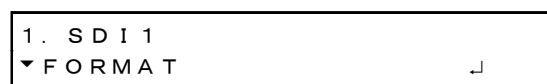

#### 12.1.1 Selecting the Image

To select the SDI signal image, follow the procedure below.

For SDI2, you cannot select 1920x1080:3G-B-DL or 1920x1080:HD-DL.

Changing this setting also changes the STRUCTURE And RATE settings.



#### Procedure

---

SDI → SDI1 → FORMAT → IMAGE

---

#### Parameters

---

720x487:SD / 720x576:SD / 1280x720:HD / 1920x1080:HD /

1280x720:3G-A / 1920x1080:3G-A / 1920x1080:3G-B-DL / 1920x1080:HD-DL

---



## 12. SDI MENU

### 12.1.2 Selecting the Color System

To select the SDI signal color system and quantization accuracy, follow the procedure below.

Changing this setting also changes the RATE settings.

```
3. SDI1 STRUCTURE
▶* 422 (YCbCr) 10-bit
```

#### Procedure

---

SDI → SDI1 → FORMAT → STRUCTURE

---

#### Parameters

---

422(YCbCr)10-bit / 422(YCbCr)12-bit / 444(YCbCr)10-bit /  
444(YCbCr)12-bit / 444(RGB)10-bit / 444(RGB)12-bit

---

### 12.1.3 Selecting the Frame Frequency

To select the SDI signal frame (field) frequency, follow the procedure below.

```
3. SDI1 RATE
▶* 59.94I
```

#### Procedure

---

SDI → SDI1 → FORMAT → RATE

---

#### Parameters

---

60I / 59.94I / 50I / 60P / 59.94P / 50P / 30P / 29.97P / 25P / 24P /  
23.98P / 30PsF / 29.97PsF / 25PsF / 24PsF / 23.98PsF

---

\* The default value is 59.94I when FORMAT SETTING is NTSC and 50I when FORMAT SETTING is PAL.

## 12.2 Adjusting the Timing

Under SDI→SDI1→TIMING, you can adjust the SDI signal relative to the reference signal.

```
1. SDI 1
  ◀ TIMING ▶
```

### 12.2.1 Selecting the Timing Reference

To select the output timing used as a reference for the SDI and black signals, follow the procedure below.

When the output signal is 3G, this menu item is not displayed. If is fixed at SERIAL.

```
3. SDI 1 0H TIMING
   ■ SERIAL □ LEGACY
```

Procedure

---

SDI → SDI1 → TIMING → 0H TIMING

---

Parameters

---

**SERIAL:** Signals are output at the timing defined in the signal standard.  
**LEGACY:** Signals are output at the same timing as LEADER's conventional signal generators.

---

### 12.2.2 Adjusting the Timing (Line)

To adjust the SDI signal relative to the reference signal at the line level, follow the procedure below.

The variable range varies depending on the format.

```
3. SDI 1 TIMING V
   0 LINE
```

Procedure

---

SDI → SDI1 → TIMING → VERTICAL

---

Parameters

---

-1124 to 0 to +1124

---

## 12.2.3 Adjusting the Timing (Dot)

To adjust the SDI signal relative to the reference signal at the dot level, follow the procedure below. To the right of DOT, the value obtained by converting dots into time is displayed.

The variable range varies depending on the format.

When IMAGE is 1920x1080 3G-B-DL and STRUCTURE is 422(YCbCr)10bit, you can set the value in 2-dot steps.

3 . S D I 1 T I M I N G H
<u>0</u> D O T           0 . 0 0 0 0 $\mu$ s

Procedure

---

SDI → SDI1 → TIMING → HORIZONTAL

---

Parameters

---

-4124 to 0 to +4124

---

## 12.3 Selecting the Pattern

To select the output pattern, follow the procedure below. To select items use the ▲, ▼, ◀, and ▶ keys.

2. SDI1 COLOR BAR ▼ ▶ * 100%
---------------------------------

## Procedure

---

SDI → SDI1 → PATTERN

---

## Parameters

---

COLOR BAR: 100% / 75% / MULTI 100% / MULTI 75% / MULTI (+I) / SMPTE / EBU / BBC

MONITOR: FLAT FIELD 100% / FLAT FIELD 0% / RED FIELD 100% / GREEN FIELD 100% / BLUE FIELD 100%

SDI: CHECK FIELD

---

The selectable patterns depend on the SDI format as shown below.

Pattern		SDI format		
		Other than those on the right	720x487:SD	720x576:SD
COLOR BAR	100%	Yes	Yes	Yes
	75%	Yes	Yes	No
	MULTI 100%	Yes	No	No
	MULTI 75%	Yes	No	No
	MULTI (+I)	Yes	No	No
	SMPTE	No	Yes	No
	EBU	No	No	Yes
	BBC	No	No	Yes
MONITOR	-	Yes	Yes	Yes
SDI	-	Yes	Yes	Yes

(Yes: Can be selected)

No: Cannot be selected)

## 12. SDI MENU

100%

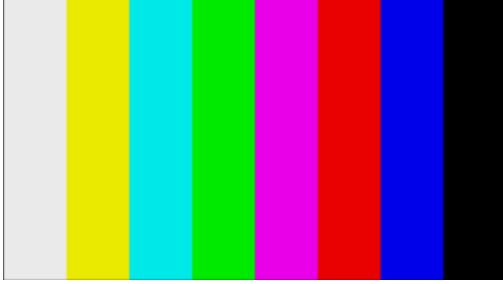

75%

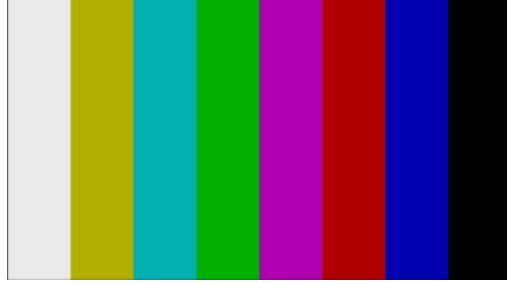

MULTI 100%



MULTI 75%



MULTI (+I)



SMPTE



EBU



BBC



## 12. SDI MENU

FLAT FIELD 100%



FLAT FIELD 0%

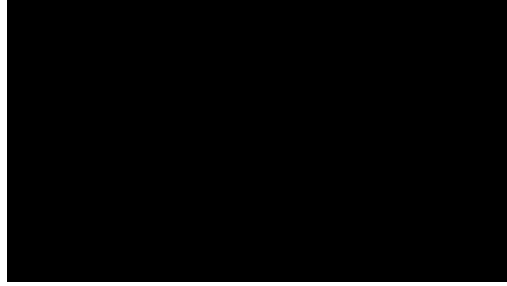

RED FIELD 100%

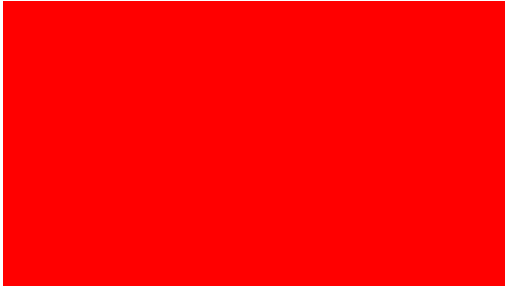

GREEN FIELD 100%

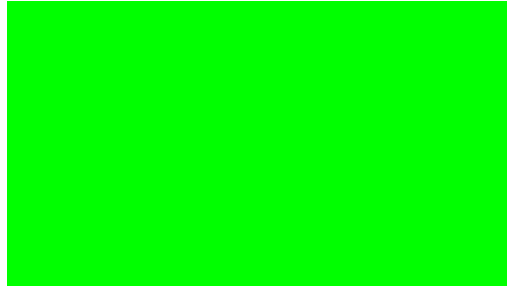

BLUE FIELD 100%

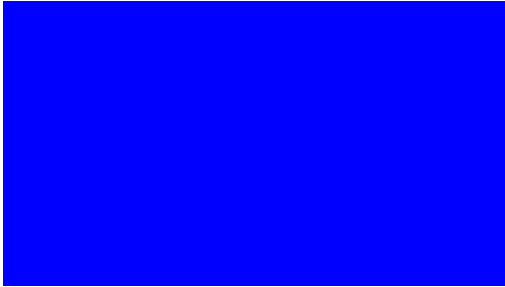

CHECK FIELD

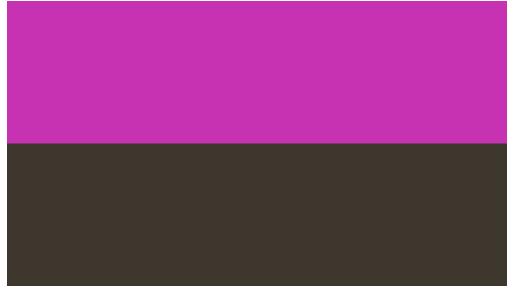

## 12.4 Turning YCbCr On and Off

To turn individual components in a YCbCr or GBR signal on and off, follow the procedure below.

This is invalid when the pattern is check field.

3. SDI 1 COMPONENT * <input type="checkbox"/> Y/G <input type="checkbox"/> Cb/B <input type="checkbox"/> Cr/R	(SDI OUTPUT option)
--	---------------------

3. SDI COMPONENT * <input type="checkbox"/> Y/G <input type="checkbox"/> Cb/B <input type="checkbox"/> Cr/R	(12G option)
--	--------------

Procedure (SDI OUTPUT option)

---

SDI → SDI1 → VIDEO → COMPONENT

---

Procedure (12G option)

---

12G OPTION → SDI 1 → VIDEO → COMPONENT

---

Parameters

---

ON / OFF

---

## 12.5 Turning Safety Area Markers On and Off

To turn on and off the 90% marker, 80% marker, and 4:3 marker separately, follow the procedure below.

If the 4:3 marker is off, the 90% marker and 80% marker are displayed at the outer frame of the picture. If it is on, the 4:3 marker is assumed to be 100%.

For SD, you cannot set the 4:3 marker. Moreover, this is invalid when the pattern is check field or when LIPSYNC is set to ON on the SDI OUTPUT option.

<pre>3 . S D I 1   S A F E T Y   A R E A  * <input type="checkbox"/> 9 0 %   <input type="checkbox"/> 8 0 %   <input type="checkbox"/> 4 : 3</pre>	(SDI OUTPUT option)
--	---------------------

<pre>3 . S D I   S A F E T Y   A R E A  * <input type="checkbox"/> 9 0 %   <input type="checkbox"/> 8 0 %   <input type="checkbox"/> 4 : 3</pre>	(12G option)
--	--------------

Procedure (SDI OUTPUT option)

---

SDI → SDI1 → VIDEO → SAFETY AREA

---

Procedure (12G option)

---

12G OPTION → SDI 1 → VIDEO → SAFETY AREA

---

Parameters

---

ON / OFF

---

90%, 80%

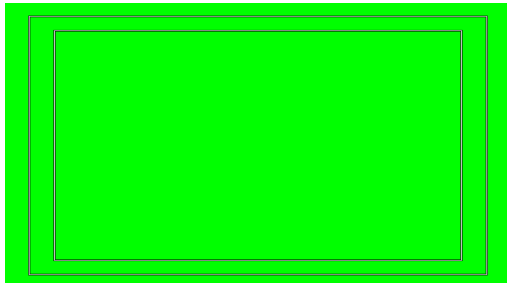

90%, 80%, 4:3

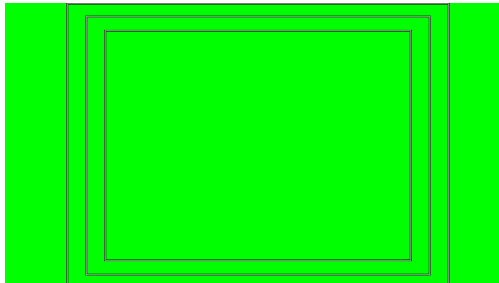



## 12.6 Configuring the Pattern Scroll Feature

With the SDI OUTPUT option, you can configure pattern scrolling under SDI→SDI1→VIDEO→SCROLL. With the 12G option, you can configure it under 12G OPTION→SDI 1→VIDEO→SCROLL.

This is invalid when the pattern is check field.

<pre>2. SDI1 VIDEO   ◆ SCROLL                ↵</pre>	(SDI OUTPUT option)
--	---------------------

<pre>2. SDI VIDEO   ◆ SCROLL                ↵</pre>	(12G option)
---	--------------

### 12.6.1 Turning Scrolling On and Off

To turn scrolling on and off, follow the procedure shown below.

<pre>4. SCROLL    □ ON      ■ OFF</pre>
---

Procedure (SDI OUTPUT option)

---

SDI → SDI1 → VIDEO → SCROLL → ON/OFF

---

Procedure (12G option)

---

12G OPTION → SDI 1 → VIDEO → SCROLL → ON/OFF

---

Parameters

---

ON / OFF

---

### 12.6.2 Setting the Vertical Scroll Speed

To select the pattern scroll speed and direction, follow the procedure below.

The unit is line/field (frame). Setting a positive value scrolls upward and a negative value downward. You can set the value in 2-dot steps for 4K and 4-dot steps for 8K.

<pre>4. SCROLL V-SPEED    0 [LINE]</pre>
--

Procedure (SDI OUTPUT option)

---

SDI → SDI1 → VIDEO → SCROLL → V-SPEED

---

Procedure (12G option)

---

12G OPTION → SDI 1 → VIDEO → SCROLL → V-SPEED

---

Parameters

---

-256 to 0 to +256

---

## 12.6.3 Setting the Horizontal Scroll Speed

To select the pattern scroll speed and direction, follow the procedure below. The unit is dot/field (frame). Setting a positive value scrolls to the right and a negative value to the left. You can set the value in 2-dot steps. You can set the value in 4-dot steps for 4K and 8-dot steps for 8K.

4. SCROLL H-SPEED <u>0</u> [DOT]
-------------------------------------

Procedure (SDI OUTPUT option)

---

SDI → SDI1 → VIDEO → SCROLL → H-SPEED

---

Procedure (12G option)

---

12G OPTION → SDI 1 → VIDEO → SCROLL → H-SPEED

---

Parameters

---

-256 to 0 to +256

---

## 12.7 Setting the Pattern Change

With the SDI OUTPUT option, you can configure pattern change under SDI→SDI1→VIDEO→PATTERN CHANGE. With the 12G option, you can configure it under 12G OPTION→SDI 1→VIDEO→PATTERN CHANGE.

This is invalid when the pattern is check field.

2. SDI1 VIDEO ◆ PATTERN CHANGE    ⌋
--

(SDI OUTPUT option)

2. SDI VIDEO ◆ PATTERN CHANGE    ⌋
---------------------------------------

(12G option)

### 12.7.1 Turning Pattern Change On and Off

To turn pattern change on and off, follow the procedure shown below.

If set to ON, the pattern is switched automatically between the available color bar patterns for the current format.

4. PATTERN CHANGE <input type="checkbox"/> ON <input checked="" type="checkbox"/> OFF
--

Procedure (SDI OUTPUT option)

---

SDI → SDI1 → VIDEO → PATTERN CHANGE → ON/OFF

---

Procedure (12G option)

---

12G OPTION → SDI 1 → VIDEO → PATTERN CHANGE → ON/OFF

---

Parameters

---

ON / OFF

---

### 12.7.2 Setting the Pattern Change Speed

To select the pattern change interval, follow the procedure below.

4. PATTERN CHG SPEED + <u>1</u> [SEC]
--

Procedure (SDI OUTPUT option)

---

SDI → SDI1 → VIDEO → PATTERN CHANGE → SPEED

---

Procedure (12G option)

---

12G OPTION → SDI 1 → VIDEO → PATTERN CHANGE → SPEED

---

Parameters

---

+1 to +255

---

## 12.8 Setting ID Characters

With the SDI OUTPUT option, you can configure the ID character under SDI→SDI1→VIDEO→ID CHARACTER. With the 12G option, you can configure it under 12G OPTION→SDI 1→VIDEO→ID CHARACTER.

A character string that you created on the LT 4610 can be displayed in a pattern. This is invalid when the pattern is check field or when LIPSYNC is set to ON on the SDI OUTPUT option.

2. SDI 1 VIDEO ◆ ID CHARACTER      ↵	(SDI OUTPUT option)
---	---------------------

2. SDI VIDEO ◆ ID CHARACTER      ↵	(12G option)
---------------------------------------	--------------

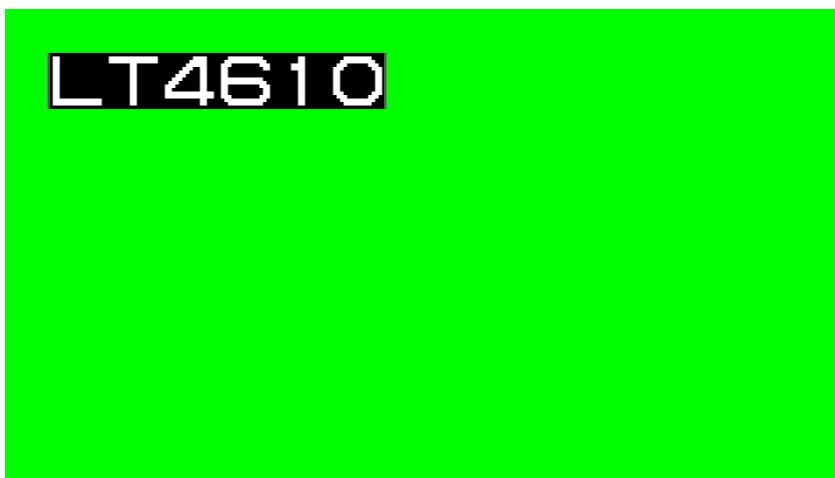

### 12.8.1 Turning ID Characters On and Off

To turn ID characters on and off, follow the procedure below.

4. ID CHARACTER <input type="checkbox"/> ON <input checked="" type="checkbox"/> OFF
--

Procedure (SDI OUTPUT option)

---

SDI → SDI1 → VIDEO → ID CHARACTER → ON/OFF

---

Procedure (12G option)

---

12G OPTION → SDI 1 → VIDEO → ID CHARACTER → ON/OFF

---

Parameters

---

ON / OFF

---

## 12.8.2 Recalling ID Characters

To recall ID characters that have been saved in the LT 4610 using the STORE menu, follow the procedure below.

```
4. I D R E C A L L
▶ L T 4 6 1 0 . i d      I N T _ 1
```

Procedure (SDI OUTPUT option)

SDI → SDI1 → VIDEO → ID CHARACTER → RECALL

Procedure (12G option)

12G OPTION → SDI 1 → VIDEO → ID CHARACTER → RECALL

Parameters

INT\_1 to INT\_4

## 12.8.3 Creating ID Characters

To create ID characters, follow the procedure below. You can enter up to 20 characters.

The ID character background is displayed in black for 20 characters worth. If you enter " ◀ " at the end of the ID character string, only the background of the entered characters will be displayed in black. (" ◀ " will not appear.)

If you enter " ◀ " in the middle of the ID character string, characters after this character will disappear, and you will not be able to edit them.

```
4. I D S E T
L T 4 6 1 0 ◀
```

Procedure (SDI OUTPUT option)

SDI → SDI1 → VIDEO → ID CHARACTER → SET

Procedure (12G option)

12G OPTION → SDI 1 → VIDEO → ID CHARACTER → SET

Parameters

▲ !"# \$%&'()\*+,-./ 0123456789:;<=>?@  
 ABCDEFGHIJKLMNOPQRSTUVWXYZ[¥]^\_→←  
 (Default value: LT4610 ◀ )

ID SET = LT4610 ◀



ID SET = LT4610



## 12.8.4 Setting the Vertical Position of ID Characters

To set the vertical position of the ID characters, follow the procedure below. You can set the value in 2-dot steps for 4K and 8K.

The value represents the coordinate at the top of the ID characters. The top of the pattern is 0.

4. ID V-POS I <u>0</u> [LINE]
----------------------------------

Procedure (SDI OUTPUT option)

---

SDI → SDI1 → VIDEO → ID CHARACTER → V-POSI

---

Procedure (12G option)

---

12G OPTION → SDI 1 → VIDEO → ID CHARACTER → V-POSI

---

Parameters

---

0 to 4319

---

## 12.8.5 Setting the Horizontal Position of ID Characters

To set the horizontal position of the ID characters, follow the procedure below. You can set the value in 4-dot steps for 4K and 8-dot steps for 8K.

The value represents the coordinate at the left end of the ID characters. The left end of the pattern is 0.

4. ID H-POS I <u>0</u> [DOT]
---------------------------------

Procedure (SDI OUTPUT option)

---

SDI → SDI1 → VIDEO → ID CHARACTER → H-POSI

---

Procedure (12G option)

---

12G OPTION → SDI 1 → VIDEO → ID CHARACTER → H-POSI

---

Parameters

---

0 to 7679

---

## 12.8.6 Selecting the Size of ID Characters

To set the size of ID characters, follow the procedure below.  
The size of x1 is 32×32 dot/character.

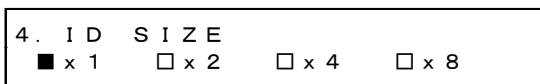

Procedure (SDI OUTPUT option)

SDI → SDI1 → VIDEO → ID CHARACTER → SIZE

Procedure (12G option)

12G OPTION → SDI 1 → VIDEO → ID CHARACTER → SIZE

Parameters

x1 / x2 / x4 / x8

## 12.8.7 Selecting the Level of ID Characters

To set the intensity level of ID characters, follow the procedure below.

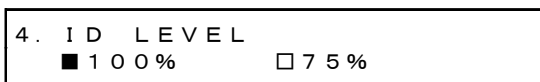

Procedure (SDI OUTPUT option)

SDI → SDI1 → VIDEO → ID CHARACTER → LEVEL

Procedure (12G option)

12G OPTION → SDI 1 → VIDEO → ID CHARACTER → LEVEL

Parameters

100% / 75%

ID LEVEL = 100%



ID LEVEL = 75%

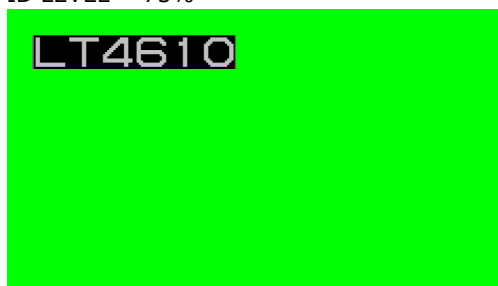

## 12.8.8 Turning ID Character Blinking On and Off

To turn ID character blinking on and off, follow the procedure below.

```
5. I D B L I N K
   □ O N           ■ O F F
```

Procedure (SDI OUTPUT option)

SDI → SDI1 → VIDEO → ID CHARACTER → BLINK → ON/OFF

Procedure (12G option)

12G OPTION → SDI 1 → VIDEO → ID CHARACTER → BLINK → ON/OFF

Parameters

ON / OFF

## 12.8.9 Setting the ID Character On-Time

To set the on-time of ID character blinking, follow the procedure below.

```
5. I D B L I N K   O N   T I M E
                   1 [ S E C ]
```

Procedure (SDI OUTPUT option)

SDI → SDI1 → VIDEO → ID CHARACTER → BLINK → ON TIME

Procedure (12G option)

12G OPTION → SDI 1 → VIDEO → ID CHARACTER → BLINK → ON TIME

Parameters

1 / 2 / 3 / 4 / 5 / 6 / 7 / 8 / 9

## 12.8.10 Setting the ID Character Off-Time

To set the off-time of ID character blinking, follow the procedure below.

```
5. I D B L I N K   O F F   T I M E
                   1 [ S E C ]
```

Procedure (SDI OUTPUT option)

SDI → SDI1 → VIDEO → ID CHARACTER → BLINK → OFF TIME

Procedure (12G option)

12G OPTION → SDI 1 → VIDEO → ID CHARACTER → BLINK → OFF TIME

Parameters

1 / 2 / 3 / 4 / 5 / 6 / 7 / 8 / 9



## 12.8.11 Turning ID Character Scrolling On and Off

To turn ID character scrolling on and off, follow the procedure below.  
If set to ON, the ID characters scroll horizontally over the pattern.



Procedure (SDI OUTPUT option)

---

SDI → SDI1 → VIDEO → ID CHARACTER → SCROLL → ON/OFF

---

Procedure (12G option)

---

12G OPTION → SDI 1 → VIDEO → ID CHARACTER → SCROLL → ON/OFF

---

Parameters

---

ON / OFF

---

## 12.8.12 Setting ID Character Scroll Speed

To set the ID character scroll speed and direction, follow the procedure below.  
The unit is dot/field (frame). Setting a positive value scrolls to the right and a negative value to the left. You can set the value in 2-dot steps. You can set the value in 4-dot steps for 4K and 8-dot steps for 8K.

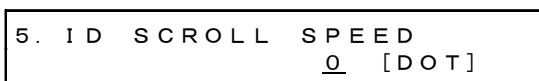

Procedure (SDI OUTPUT option)

---

SDI → SDI1 → VIDEO → ID CHARACTER → SCROLL → SPEED

---

Procedure (12G option)

---

12G OPTION → SDI 1 → VIDEO → ID CHARACTER → SCROLL → SPEED

---

Parameters

---

-256 to 0 to +256

---

## 12.8.13 Saving ID Characters

To store up to four sets of ID characters that you create on the SET menu, follow the procedure below.

Only the characters are saved. Position, size, and the like are not saved.

Procedure (SDI OUTPUT option)

---

SDI → SDI1 → VIDEO → ID CHARACTER → STORE

---

Procedure (12G option)

---

12G OPTION → SDI 1 → VIDEO → ID CHARACTER → STORE

---

To save ID characters, follow the procedure below.

1. Enter a file name.

Select STORE. The file name input menu appears. This is the name assigned to the ID characters and is also the file name when the ID characters are copied to a USB memory device.

The characters that you can use are as follows. Up to eight characters can be entered.

▲0123456789ABCDEFGHIJKLMN OPQRSTUVWXYZ\_

Enter "▲" to clear characters that follow it. "▲" is not entered in the file name.

4. I D S T O R E L T 4 6 1 0 ◀
-----------------------------------

2. Select the save destination in the LT 4610.

Select from INT\_1 to INT\_4. If there are already ID characters stored at the destination, they are overwritten.

5. I D S T O R E ▶ N O D A T A I N T _ 1
---

3. Select the OK.

6. I D S T O R E ■ O K □ C A N C E L
---

12.8.14 Copying ID Characters to the LT 4610

To copy up to four sets of ID characters from a USB memory device to the LT 4610, follow the procedure below. This feature is useful when you want to use multiple LT 4610s with the same settings. (Copy the ID characters to the USB memory device in advance by using the COPY INT→USB menu.)

This setting appears when a USB memory device is connected.

Procedure (SDI OUTPUT option)

SDI → SDI1 → VIDEO → ID CHARACTER → COPY USB→INT

Procedure (12G option)

12G OPTION → SDI 1 → VIDEO → ID CHARACTER → COPY USB→INT

To copy ID characters, follow the procedure below.

1. Select the copy destination in the LT 4610.

Select from INT\_1 to INT\_4. If there are already ID characters stored in the LT 4610, they are overwritten.



2. Select the copy source in the USB memory device.

The id file in the ID folder of the USB memory device (with the SDI OUTPUT option) or the id file in the 12G\_ID folder (with the 12G option) is displayed here.



3. Select the OK.



- USB memory configuration (SDI OUTPUT option)

ID characters are copied from the ID folder of the USB memory device.

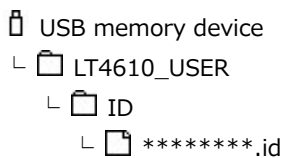

- USB memory configuration (12G option)

ID characters are copied from the 12G\_ID folder of the USB memory device.



12.8.15 Copying ID Characters to a USB Memory Device

To copy ID characters in id format (dedicated format) from the LT 4610 to a USB memory device, follow the procedure below. This feature is useful when you want to use multiple LT 4610s with the same settings. (Save the ID characters in the LT 4610 in advance by using the STORE menu.)

This setting appears when a USB memory device is connected.

Procedure (SDI OUTPUT option)

---

SDI → SDI1 → VIDEO → ID CHARACTER → COPY INT→USB

---

Procedure (12G option)

---

12G OPTION → SDI 1 → VIDEO → ID CHARACTER → COPY INT→USB

---

To copy ID characters, follow the procedure below.

1. Select the copy source in the LT 4610.

Select ALL or from INT\_1 to INT\_4.



2. Select the OK.

If there are already ID characters with the same file names stored in the USB memory device, they will be overwritten. If ALL is selected and ID characters with the same file name are saved in INT\_1 to INT\_4, only a single set with the largest number (INT\_\*) is saved.



- USB memory configuration (SDI OUTPUT option)

ID characters are copied to the ID folder of the USB memory device. (See 12.8.14, "Copying ID Characters to the LT 4610.")

The date and time of the file will be those selected in 21.6.1, "Selecting the Date and Time."

- USB memory configuration (12G option)

ID characters are copied to the 12G\_ID folder of the USB memory device. (See 12.8.14, "Copying ID Characters to the LT 4610.")

The date and time of the file will be those selected in 21.6.1, "Selecting the Date and Time."

- "\*\*\*\*\*.id" example

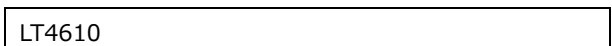

## 12.8.16 Clearing ID Characters

To clear ID characters that have been saved in the LT 4610 using the STORE menu, follow the procedure below.

Procedure (SDI OUTPUT option)

---

SDI → SDI1 → VIDEO → ID CHARACTER → DELETE

---

Procedure (12G option)

---

12G OPTION → SDI 1 → VIDEO → ID CHARACTER → DELETE

---

To clear ID characters, follow the procedure below.

1. Select the ID characters you want to clear.

Select ALL or from INT\_1 to INT\_4.



4. I D D E L E T E  
▶ A L L

2. Select the OK.



5. I D D E L E T E  
■ O K                      □ C A N C E L

## 12.9 Setting Logos

With the SDI OUTPUT option, you can set the logo under SDI→SDI1→VIDEO→LOGO. With the 12G option, you can set it under 12G OPTION→SDI 1→VIDEO→LOGO.

A 4-level monochrome image that you created on your PC can be displayed in a pattern. This is invalid when the pattern is check field or when LIPSYNC is set to ON on the SDI OUTPUT option.

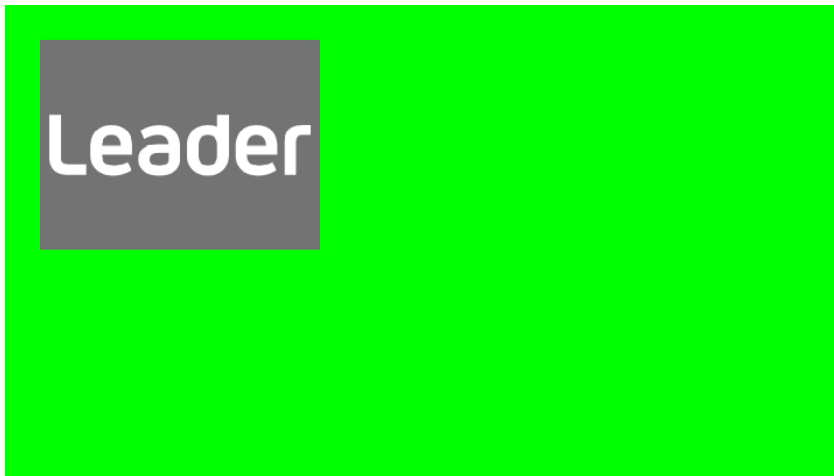
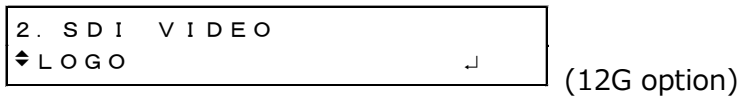

## 12.9.1 Display procedure

This describes the procedure from creating a logo to displaying it in a pattern. In this example, the logo file name is "LEADER.bmp."

1. Create a logo on your PC.

Create an image in bmp format according to the following conditions.

File name: Up to eight characters (excluding the extension) consisting of alphanumeric characters or underscore.

File format: 24 bits, 256 colors or 16 colors

File size: Up to 320 dots × 240 lines (width × height)

LEADER.bmp



2. Using the accompanying Logo App, convert it to lg format.

The image is converted into 4-level monochrome data.

[See also] 22, "LOGO APP"

LEADER.lg

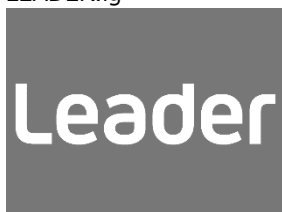

3. Place the converted logo in the USB memory device.

- SDI OUTPUT option

📁 USB memory device

└─ 📁 LT 4610\_USER

    └─ 📁 LOGO

        └─ 📁 LEADER.lg

- 12G option

📁 USB memory device

└─ 📁 LT 4610\_USER

    └─ 📁 12G\_LOGO

        └─ 📁 LEADER.lg

## 12. SDI MENU

4. On the COPY USB→INT menu, import the logo into the LT 4610.

In this example, the file is imported into INT\_1 of the LT 4610.

[See also] 12.9.8, "Copying Logos to the LT 4610"

```
4. LOGO COPY USB→INT
▶NO DATA          INT_1
```



```
5. LOGO COPY USB→INT
▶LEADER. I g      1 / 1
```

5. On the SELECT menu, select the logo.

[See also] 12.9.3, "Selecting a Logo"

```
4. LOGO SELECT
▶*LEADER. I g      INT_1
```

6. On the ON/OFF menu, select ON.

[See also] 12.9.2, "Turning the Logo On and Off"

```
4. LOGO
   ■ ON      □ OFF
```

### 12.9.2 Turning the Logo On and Off

To turn the logo on and off, follow the procedure below.

```
4. LOGO
   □ ON      ■ OFF
```

Procedure (SDI OUTPUT option)

---

SDI → SDI1 → VIDEO → LOGO → ON/OFF

---

Procedure (12G option)

---

12G OPTION → SDI 1 → VIDEO → LOGO → ON/OFF

---

Parameters

---

ON / OFF

---



## 12.9.3 Selecting a Logo

To select the logo to be displayed, follow the procedure below.

A logo must be copied to INT\_1 to INT\_4 in advance using the COPY USB→INT menu.

```
4. LOGO SELECT
▶ * LEADER. I g      INT__1
```

Procedure (SDI OUTPUT option)

SDI → SDI1 → VIDEO → LOGO → SELECT

Procedure (12G option)

12G OPTION → SDI 1 → VIDEO → LOGO → SELECT

Parameters

INT\_1 to INT\_4

## 12.9.4 Setting the Vertical Logo Position

To set the vertical logo position, follow the procedure below.

The value represents the coordinate at the top of the logo. The top of the pattern is 0. You can set the value in 2-dot steps for 4K and 8K.

```
4. LOGO V-POS I
      0 [LINE]
```

Procedure (SDI OUTPUT option)

SDI → SDI1 → VIDEO → LOGO → V-POS I

Procedure (12G option)

12G OPTION → SDI 1 → VIDEO → LOGO → V-POS I

Parameters

0 to 4319

## 12.9.5 Setting the Horizontal Logo Position

To set the horizontal logo position, follow the procedure below.

The value represents the coordinate at the left end of the logo. The left end of the pattern is 0. You can set the value in 4-dot steps for 4K and 8-dot steps for 8K.

```
4. LOGO H-POS I
      0 [DOT]
```

Procedure (SDI OUTPUT option)

SDI → SDI1 → VIDEO → LOGO → H-POS I

Procedure (12G option)

12G OPTION → SDI 1 → VIDEO → LOGO → H-POS I

Parameters

0 to 7679

## 12.9.6 Setting the Logo Level

To set the logo intensity level, follow the procedure below.

Logos are made of 4-level monochrome data (LEVEL0, LEVEL1, LEVEL2, LEVEL3). You can set the display intensity level for each level.

When LOGO BACKGND is set to ON, LEVEL0 is invalid.

```
5. LOGO LEVEL 0
      100h ( 0%)
```

```
5. LOGO LEVEL 1
      590h ( 33%)
```

```
5. LOGO LEVEL 2
      A20h ( 66%)
```

```
5. LOGO LEVEL 3
      EB0h (100%)
```

Procedure (SDI OUTPUT option)

SDI → SDI1 → VIDEO → LOGO → LEVEL → LEVEL0 / LEVEL1 / LEVEL2 / LEVEL3

Procedure (12G option)

12G OPTION → SDI 1 → VIDEO → LOGO → LEVEL → LEVEL0 / LEVEL1 / LEVEL2 / LEVEL3

Parameters

100h(0%) to EB0h(100%)

(LEVEL0 default value: 100h(0%), LEVEL1 default value: 590h(33%),

LEVEL2 default value: A20h(66%), LEVEL3 default value: EB0h(100%))

## 12.9.7 Setting the Logo Transparency

To select whether to make the area set to LEVEL0 transparent, follow the procedure below.



Procedure (SDI OUTPUT option)

---

SDI → SDI1 → VIDEO → LOGO → BACKGND

---

Procedure (12G option)

---

12G OPTION → SDI 1 → VIDEO → LOGO → BACKGND

---

Parameters

---

ON:                The area is made transparent.

OFF:                The area is not made transparent.

---

LOGO BACKGND = ON

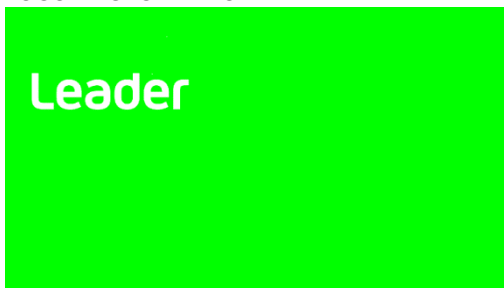

LOGO BACKGND = OFF

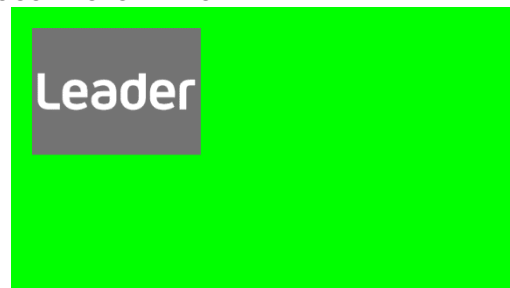

## 12.9.8 Copying Logos to the LT 4610

To copy up to four logos from a USB memory device to the LT 4610, follow the procedure below. (Copy the logos to the USB memory device or place the logos created on your PC in advance by using the COPY INT→USB menu.)

This setting appears when a USB memory device is connected.

Procedure (SDI OUTPUT option)

---

SDI → SDI1 → VIDEO → LOGO → COPY USB→INT

---

Procedure (12G option)

---

12G OPTION → SDI 1 → VIDEO → LOGO → COPY USB→INT

---

To copy logos, follow the procedure below.

1. Select the copy destination in the LT 4610.

Select from INT\_1 to INT\_4. If there are already logos stored at the destination, they are overwritten.

```
4. LOGO COPY USB→INT
▶NO DATA          INT_1
```

2. Select the copy source in the USB memory device.

The lg file in the LOGO folder of the USB memory device (with the SDI OUTPUT option) or the id file in the 12G\_LOGO folder (with the 12G option) is displayed here.

```
5. LOGO COPY USB→INT
▶LEADER. lg       1 / 1
```

3. Select the OK.

```
6. LOGO COPY USB→INT
  ■OK          □CANCEL
```

- USB memory configuration (SDI OUTPUT option)

Logos are copied from the LOGO folder of the USB memory device.

```
📁 USB memory device
├── 📁 LT4610_USER
│   └── 📁 LOGO
│       └── 📄 *****.lg
```

- USB memory configuration (12G option)

Logos are copied from the 12G\_LOGO folder of the USB memory device.

```
📁 USB memory device
├── 📁 LT4610_USER
│   └── 📁 12G_LOGO
│       └── 📄 *****.lg
```

## 12.9.9 Copying Logos to a USB Memory Device

To copy logos in lg format (dedicated format) from the LT 4610 to a USB memory device, follow the procedure below. Copy a logo to the LT 4610 in advance using the COPY USB→INT menu.

This setting appears when a USB memory device is connected.

Procedure (SDI OUTPUT option)

---

SDI → SDI1 → VIDEO → LOGO → COPY INT→USB

---

Procedure (12G option)

---

12G OPTION → SDI 1 → VIDEO → LOGO → COPY INT→USB

---

To copy logos, follow the procedure below.

1. Select the copy source in the LT 4610.

Select ALL or from INT\_1 to INT\_4.

4. LOGO COPY INT→USB  
▶ ALL

2. Select the OK.

If there are already logos with the same file names stored in the USB memory device, they will be overwritten. If ALL is selected and logos with the same file name are saved in INT\_1 to INT\_4, only a single set with the largest number (INT\_\*) is saved.

5. LOGO COPY INT→USB  
■ OK                    □ CANCEL

- USB memory configuration (SDI OUTPUT option)

Logos are copied to the LOGO folder of the USB memory device. (See 12.9.8, "Copying Logos to the LT 4610.")

The date and time of the file will be those selected in 21.6.1, "Selecting the Date and Time."

- USB memory configuration (12G option)

Logos are copied to the 12G\_LOGO folder of the USB memory device. (See 12.9.8, "Copying Logos to the LT 4610.")

The date and time of the file will be those selected in 21.6.1, "Selecting the Date and Time."

## 12.9.10 Clearing a Logo

To clear the logos that you copied to the LT 4610 using the COPY USB→INT menu, follow the procedure below.

Procedure (SDI OUTPUT option)

---

SDI → SDI1 → VIDEO → LOGO → DELETE

---

Procedure (12G option)

---

12G OPTION → SDI 1 → VIDEO → LOGO → DELETE

---

To clear logos, follow the procedure below.

1. Select the logos you want to clear.

Select ALL or from INT\_1 to INT\_4.



4. LOGO DELETE  
▶ ALL

2. Select the OK.



5. LOGO DELETE  
■ OK                    □ CANCEL

### 12.10 Configuring Embedded Audio

16 (HD(DL)) audio channels (32 channels for 3G-B) can be embedded in an SDI signal. (Embedding is not possible when the pattern is a check field.)

Channels 1 to 4, 5 to 8, 9 to 12, and 13 to 16 are called group 1, 2, 3, and 4, respectively. The frequency, level, and the like can be set for each channel separately.

In addition, if you link the group 2 settings to the group 1 settings, you only need to set group 1, and the group 2 settings will automatically be set to the same values as group 1.

SDI Signal	Link A (HD(DL), 3G-B only)	Group 1	1ch
			Ch2 (Ch1 also possible)
			Ch3 (Ch1 also possible)
			Ch4 (Ch1 also possible)
		Group 2 (can also be set equal to group 1)	5ch
			Ch6 (Ch5 also possible)
			Ch7 (Ch5 also possible)
			Ch8 (Ch5 also possible)
		Group 3 (can also be set equal to group 1)	9ch
			Ch10 (Ch9 also possible)
			Ch11 (Ch9 also possible)
			Ch12 (Ch9 also possible)
	Group 4 (can also be set equal to group 3)	13ch	
		Ch14 (Ch13 also possible)	
		Ch15 (Ch13 also possible)	
		Ch16 (Ch13 also possible)	
Link B (HD(DL), 3G-B only) (can also be set to link A)	Same as link A		

## 12. SDI MENU

### 12.10.1 Turning the Audio On and Off

To turn the audio on or off at the group level, follow the procedure below.

3. SDI 1 AUDIO ON/OFF
* <input checked="" type="checkbox"/> G 1 <input checked="" type="checkbox"/> G 2 <input checked="" type="checkbox"/> G 3 <input checked="" type="checkbox"/> G 4

 (SDI OUTPUT option)

3. SDI AUDIO ON/OFF
* <input checked="" type="checkbox"/> G 1 <input checked="" type="checkbox"/> G 2 <input checked="" type="checkbox"/> G 3 <input checked="" type="checkbox"/> G 4

 (12G option)

Procedure (SDI OUTPUT option)

---

SDI → SDI1 → AUDIO (→ LINK-A / LINK-B) → ON/OFF

---

Procedure (12G option)

---

12G OPTION → SDI 1 → AUDIO (→ LINK-A / LINK-B) → ON/OFF

---

Parameters

---

ON / OFF

---

### 12.10.2 Selecting the Resolution

To select the resolution for the selected group, follow the procedure below.

If the output signal is 525/59.94I, not all groups can be set to 24BIT. Up to three groups can be set to 24BIT.

4. G 1 RESOLUTION
<input checked="" type="checkbox"/> 20BIT <input type="checkbox"/> 24BIT

Procedure (SDI OUTPUT option)

---

SDI → SDI1 → AUDIO (→ LINK-A / LINK-B) → G1 / G2 / G3 / G4 → RESOLUTION

---

Procedure (12G option)

---

12G OPTION → SDI 1 → AUDIO (→ LINK-A / LINK-B) → G1 / G2 / G3 / G4 → RESOLUTION

---

Parameters

---

20BIT / 24BIT

---



## 12.10.3 Selecting the Pre-emphasis Mode

To select the pre-emphasis mode for the selected group, follow the procedure below.

```
4. G 1  E M P H A S I S
    5 0 / 1 5   C C I T T   O F F
```

Procedure (SDI OUTPUT option)

SDI → SDI1 → AUDIO (→ LINK-A / LINK-B) → G1 / G2 / G3 / G4 → EMPHASIS

Procedure (12G option)

12G OPTION → SDI 1 → AUDIO (→ LINK-A / LINK-B) → G1 / G2 / G3 / G4 → EMPHASIS

Parameters

50/15 / CCITT / OFF

## 12.10.4 Selecting the Frequency

To select the frequency of the selected channel, follow the procedure below.

```
5. G 1 / C H 1  F R E Q
   ◀ * 1 k H z
```

Procedure (SDI OUTPUT option)

SDI → SDI1 → AUDIO (→ LINK-A / LINK-B)  
 → G1 → CH1 / CH2 / CH3 / CH4 → FREQ  
 → G2 → CH5 / CH6 / CH7 / CH8 → FREQ  
 → G3 → CH9 / CH10 / CH11 / CH12 → FREQ  
 → G4 → CH13 / CH14 / CH15 / CH16 → FREQ

Procedure (12G option)

12G OPTION → SDI 1 → AUDIO (→ LINK-A / LINK-B)  
 → G1 → CH1 / CH2 / CH3 / CH4 → FREQ  
 → G2 → CH5 / CH6 / CH7 / CH8 → FREQ  
 → G3 → CH9 / CH10 / CH11 / CH12 → FREQ  
 → G4 → CH13 / CH14 / CH15 / CH16 → FREQ

Parameters

SILENCE / 400Hz / 800Hz / 1kHz

## 12.10.5 Setting the Level

To set the level of the selected channel, follow the procedure below.

```
5. G 1 / CH 1  L E V E L
      - 2 0  [ d B F S ]
```

---

 Procedure (SDI OUTPUT option)

SDI → SDI1 → AUDIO (→ LINK-A / LINK-B)  
 → G1 → CH1 / CH2 / CH3 / CH4 → LEVEL  
 → G2 → CH5 / CH6 / CH7 / CH8 → LEVEL  
 → G3 → CH9 / CH10 / CH11 / CH12 → LEVEL  
 → G4 → CH13 / CH14 / CH15 / CH16 → LEVEL

---

## Procedure (12G option)

12G OPTION → SDI 1 → AUDIO (→ LINK-A / LINK-B)  
 → G1 → CH1 / CH2 / CH3 / CH4 → LEVEL  
 → G2 → CH5 / CH6 / CH7 / CH8 → LEVEL  
 → G3 → CH9 / CH10 / CH11 / CH12 → LEVEL  
 → G4 → CH13 / CH14 / CH15 / CH16 → LEVEL

---

## Parameters

-60 to -20 to 0

---

## 12.10.6 Setting Clicks

You can insert click sounds into the selected channel. Follow the procedure below to set the insertion interval to a value other than OFF.

This is invalid when LIPSYNC is set to ON.

```
5. G 1 / CH 1  C L I C K
  ▶ * O F F
```

---

 Procedure (SDI OUTPUT option)

SDI → SDI1 → AUDIO (→ LINK-A / LINK-B)  
 → G1 → CH1 / CH2 / CH3 / CH4 → CLICK  
 → G2 → CH5 / CH6 / CH7 / CH8 → CLICK  
 → G3 → CH9 / CH10 / CH11 / CH12 → CLICK  
 → G4 → CH13 / CH14 / CH15 / CH16 → CLICK

---

## Procedure (12G option)

12G OPTION → SDI 1 → AUDIO (→ LINK-A / LINK-B)  
 → G1 → CH1 / CH2 / CH3 / CH4 → CLICK  
 → G2 → CH5 / CH6 / CH7 / CH8 → CLICK  
 → G3 → CH9 / CH10 / CH11 / CH12 → CLICK  
 → G4 → CH13 / CH14 / CH15 / CH16 → CLICK

---

## Parameters

OFF / 1sec / 2sec / 4sec

---

## 12.10.7 Settings Shared by Links

If the output signal is HD(DL) or 3G-B, the link B settings can be linked to link A settings by following the procedure below to select ON. In this situation, link B cannot be set.

4. SDI 1 L-B EQUAL L-A
<input checked="" type="checkbox"/> ON <input type="checkbox"/> OFF

Procedure (SDI OUTPUT option)

---

SDI → SDI1 → AUDIO → LINK-B → EQUAL TO LINK-A

---

Procedure (12G option)

---

12G OPTION → SDI 1 → AUDIO → LINK-B → EQUAL TO LINK-A

---

Parameters

---

ON / OFF

---

## 12.10.8 Settings Shared by Groups

You can link the group 2 settings to the group 1 settings by following the procedure below to set G2 EQUAL TO G1 to ON. In this situation, group 2 cannot be set.

The same holds true for G3 EQUAL TO G1 and G4 EQUAL TO G3.

4. G 2 EQUAL TO G 1
<input checked="" type="checkbox"/> ON <input type="checkbox"/> OFF

4. G 3 EQUAL TO G 1
<input checked="" type="checkbox"/> ON <input type="checkbox"/> OFF

4. G 4 EQUAL TO G 3
<input checked="" type="checkbox"/> ON <input type="checkbox"/> OFF

Procedure (SDI OUTPUT option)

---

SDI → SDI1 → AUDIO (→ LINK-A / LINK-B)

→ G2 → EQUAL TO G1

→ G3 → EQUAL TO G1

→ G4 → EQUAL TO G3

---

Procedure (12G option)

---

12G OPTION → SDI 1 → AUDIO (→ LINK-A / LINK-B)

→ G2 → EQUAL TO G1

→ G3 → EQUAL TO G1

→ G4 → EQUAL TO G3

---

Parameters

---

ON / OFF

---

## 12. SDI MENU

### 12.10.9 Settings Shared by Channels

You can link the channel 2 setting to the channel 1 setting by following the procedure below to set G1/CH2 EQUAL CH1 to ON. In this situation, channel 2 cannot be set. The same holds true for the other similar settings.

5. G 1 / CH 2    E Q U A L    C H 1 <input checked="" type="checkbox"/> O N <input type="checkbox"/> O F F
---

5. G 2 / CH 6    E Q U A L    C H 5 <input checked="" type="checkbox"/> O N <input type="checkbox"/> O F F
---

5. G 3 / CH 1 0    E Q U A L    C H 9 <input checked="" type="checkbox"/> O N <input type="checkbox"/> O F F
---

5. G 4 / CH 1 4    E Q U A L    C H 1 3 <input checked="" type="checkbox"/> O N <input type="checkbox"/> O F F
---

#### Procedure (SDI OUTPUT option)

---

SDI → SDI1 → AUDIO (→ LINK-A / LINK-B)  
→ G1 → CH2 / CH3 / CH4 → EQUAL TO CH1  
→ G2 → CH6 / CH7 / CH8 → EQUAL TO CH5  
→ G3 → CH10 / CH11 / CH12 → EQUAL TO CH9  
→ G4 → CH14 / CH15 / CH16 → EQUAL TO CH13

---

#### Procedure (12G option)

---

12G OPTION → SDI 1 → AUDIO (→ LINK-A / LINK-B)  
→ G1 → CH2 / CH3 / CH4 → EQUAL TO CH1  
→ G2 → CH6 / CH7 / CH8 → EQUAL TO CH5  
→ G3 → CH10 / CH11 / CH12 → EQUAL TO CH9  
→ G4 → CH14 / CH15 / CH16 → EQUAL TO CH13

---

#### Parameters

---

ON / OFF

---

## 12.11 Turing the Time Code On and Off (SER01/SER04)

To turn on or off the time code insertion selected in 21.7.1, "Selecting the Time Code," follow the procedure below.

3. ANC ATC-LTC
<input type="checkbox"/> ON <input checked="" type="checkbox"/> OFF

Procedure

---

SDI → SDI1 → ANC → ATC-LTC ON/OFF

---

Parameters

---

ON / OFF

---

## 12.12 Common SDI Signal Settings

You can link the SDI2 setting to the SDI1 setting by following the procedure below to select ON.

In this situation, SDI2 cannot be set.

2. SDI2 EQUAL TO SDI1
<input checked="" type="checkbox"/> ON <input type="checkbox"/> OFF

Procedure

---

SDI → SDI2 → EQUAL TO SDI1

---

Parameters

---

ON / OFF

---

## 13. AES/EBU MENU

The AES/EBU menu is used to specify settings related to AES/EBU output and silence output. For the LT 4611, you can select this option when SER23 is installed.

To display the AES/EBU menu, press MENU several times until the following menu appears.

```

0. AES/EBU
▼ AES/EBU
  
```

### 13.1 Setting the AES/EBU Output

Under AES/EBU→AES/EBU, you can set the AES/EBU output.

```

0. AES/EBU
▼ AES/EBU
  
```

#### 13.1.1 Turning the Audio Output On and Off

To turn the audio output on or off, follow the procedure below.

```

2. AES/EBU
   ■ ON      □ OFF
  
```

Procedure

AES/EBU → AES/EBU → ON/OFF

Parameters

ON / OFF

#### 13.1.2 Selecting the Frequency

To select the frequency of the selected channel, follow the procedure below.

```

4. AES/EBU CH1 FREQ
   ◀ * 1 k H z
  
```

Procedure

AES/EBU → AES/EBU → SETTING → CH1 / CH2 → FREQ

Parameters

SILENCE / 400Hz / 800Hz / 1kHz

## 13.1.3 Setting the Level

To set the level of the selected channel, follow the procedure below.

```
4. AES/EBU CH1 LEVEL
   -20 [dBFS]
```

Procedure

AES/EBU → AES/EBU → SETTING → CH1 / CH2 → LEVEL

Parameters

-60 to -20 to 0

## 13.1.4 Setting Clicks

You can insert click sounds into the selected channel. Follow the procedure below to set the insertion interval to a value other than OFF.

This is invalid when LIPSYNC SDI1+AES on the ETC menu is set to ON.

```
4. AES/EBU CH1 CLICK
   ▶ * OFF
```

Procedure

AES/EBU → AES/EBU → SETTING → CH1 / CH2 → CLICK

Parameters

OFF / 1sec / 2sec / 4sec

## 13.1.5 Settings Shared by Channels

You can link the channel 2 setting to the channel 1 setting by following the procedure below to select ON. In this situation, channel 2 cannot be set.

```
4. CH2 EQUAL TO CH1
   ■ ON      □ OFF
```

Procedure

AES/EBU → AES/EBU → SETTING → CH2 → EQUAL TO CH1

Parameters

ON / OFF

## 13.1.6 Selecting the Resolution

To select the resolution, follow the procedure below.

3. AES/EBU RESOLUTION <input checked="" type="checkbox"/> 20BIT <input type="checkbox"/> 24BIT
---

Procedure

AES/EBU → AES/EBU → SETTING → RESOLUTION

Parameters

20BIT / 24BIT

## 13.1.7 Selecting the Pre-emphasis Mode

To select the pre-emphasis mode, follow the procedure below.

3. AES/EBU EMPHASIS <input type="checkbox"/> 50/15 <input type="checkbox"/> CCITT <input checked="" type="checkbox"/> OFF
--

Procedure

AES/EBU → AES/EBU → SETTING → EMPHASIS

Parameters

50/15 / CCITT / OFF

## 13.1.8 Turing the Time Code On and Off

To turn on or off the time code insertion selected in 21.7.1, "Selecting the Time Code," follow the procedure below.

3. AES/EBU TIMECODE <input type="checkbox"/> ON <input checked="" type="checkbox"/> OFF
--

Procedure

AES/EBU → AES/EBU → SETTING → TIMECODE

Parameters

ON / OFF



## 13.1.9 Adjusting the Timing

To adjust the AES/EBU signal timing relative to the reference signal in the range of  $\pm 1$ AES/EBU frame, follow the procedure below.

```
2. AES / EBU TIMING
      0 [FS]
```

Procedure

AES/EBU → AES/EBU → TIMING

Parameters

-511 to 0 to +511

## 13.2 Setting the Silence Output

Under AES/EBU→SILENCE, you can set the silence output.

```
0. AES / EBU
  ^ SILENCE          ⌋
```

## 13.2.1 Selecting the Resolution

To select the resolution, follow the procedure below.

```
3. SILENCE RESOLUTION
   ■ 20BIT   □ 24BIT
```

Procedure

AES/EBU → SILENCE → SETTING → RESOLUTION

Parameters

20BIT / 24BIT

## 13.2.2 Adjusting the Timing

To adjust the silence signal timing relative to the reference signal in the range of  $\pm 1$ AES/EBU frame, follow the procedure below.

```
2. SILENCE TIMING
      0 [FS]
```

Procedure

AES/EBU → SILENCE → TIMING

Parameters

-511 to 0 to +511

## 14. WCLK MENU

The WCLK menu is used to specify settings related to WCLK output.

To display the WCLK menu, press MENU several times until the following menu appears.

0. WCLK TIMING	↵
-------------------	---

### 14.1 Adjusting the Timing

To adjust the word-clock signal relative to the reference signal in the range of  $\pm 1\text{AES/EBU}$  frame, follow the procedure below.

1. WCLK TIMING	<u>0</u> [FS]
----------------	---------------

Procedure

---

WCLK → TIMING

---

Parameters

---

-511 to 0 to +511

---

## 15. ETC MENU

The ETC menu is used to specify settings related to lip sync.

To display the ETC menu, press MENU several times until the following menu appears. For the LT 4611, you can select this option when SER22 is installed.



### 15.1 Turning Lip Sync On and Off

To turn lip sync pattern on and off, follow the procedure below. It can be turned on and off separately for SDI1+AES/EBU signals and SDI2 signals.

When turned on, the LT 4610 outputs lip sync patterns. Combining this with our lip-sync-compatible waveform monitor makes it possible to measure the offset between the video signal and the audio signal that occurs in the transfer route for each channel. For details, see the instruction manual of the waveform monitor.

This is invalid when the SDI signal pattern is check field.



#### Procedure

ETC → LIP SYNC → SDI1+AES / SDI2

#### Parameters

ON / OFF

If set to ON, set all audio channels as follows on the SDI menu (SER22) and the AES/EBU menu (SER23) for AES/EBU signals.

These settings are factory default settings.

	Item	Setting
SDI menu	AUDIO ON/OFF	ON
	FREQ	1kHz
	LEVEL	-20
	RESOLUTION	20BIT
	EMPHASIS	OFF
AES/EBU menu	AES/EBU ON/OFF	ON
	FREQ	1kHz
	LEVEL	-20
	RESOLUTION	20BIT
	EMPHASIS	OFF

## 15.2 Description of Lip Sync Patterns

A lip sync pattern is divided into three areas. From the top, they are the pattern, raster, and scale areas. Audio is turned on or muted in sync with the image signal.

- Pattern

The pattern specified by PATTERN on the SDI menu is displayed.

Safety area markers, ID characters, and logo are not displayed even if they are set to ON.

- Raster

If the scale slide bar is between 0 and +15 [frames], a white raster is displayed. If not, a black raster is displayed.

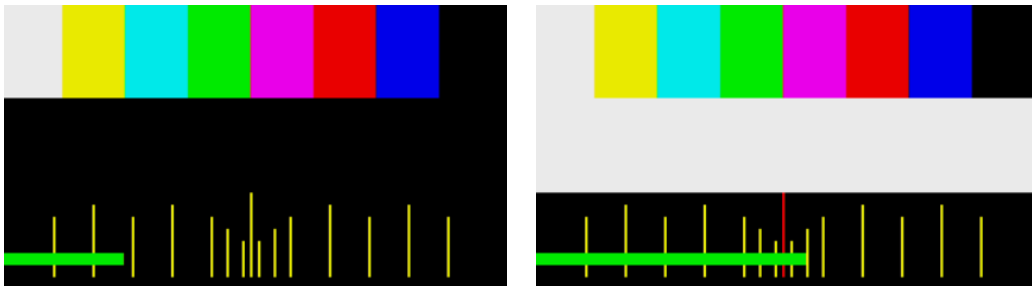

- Scale

A green slide bar scrolls from left to right (approximately 6 seconds for 1080/59.94I).

The center scale turns red when the slide bar is between 0 and +15 [frames].

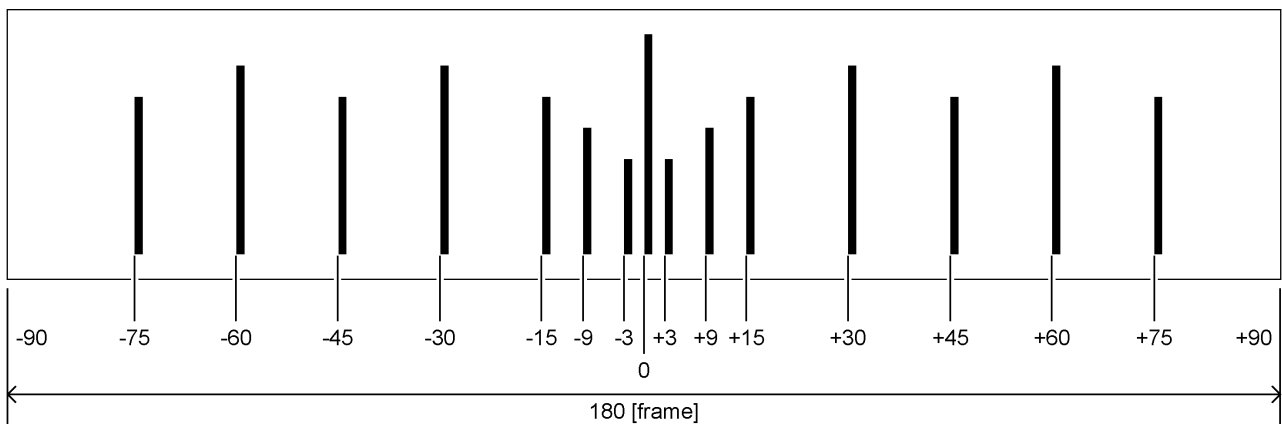

- Audio

If the scale slide bar is between 0 and +15 [frames], audio turns on. If not, audio is muted. The click setting is invalid.

## 16. GPS OPTION MENU (SER01)

The GPS OPTION menu is used to specify settings related to LTC output and CW I/O. You can select this option when SER01 is installed.

To display the GPS OPTION menu, press MENU several times until the following menu appears.

```

0. GPS OPTION
▼ LTC
    
```

### 16.1 Setting the LTC Output

Under GPS OPTION→LTC, you can set the LTC output.

```

0. GPS OPTION
▼ LTC
    
```

#### 16.1.1 Turing the Time Code Output On and Off

To turn the time code outputs (LTC1 to LTC3) on and off, follow the procedure below.

The time code selected in 21.7.1, "Selecting the Time Code," is output from LTC IN/OUT on the rear panel.

```

2. LTC
   □ ON      ■ OFF
    
```

Procedure

GPS OPTION → LTC → ON/OFF

Parameters

ON / OFF

#### 16.1.2 Adjusting the Time Code Output Timing (Frame)

To adjust the time code outputs (LTC1 to LTC3) at the frame level, follow the procedure below.

The adjustable range depends on the BLK1 format.

```

3. LTC TIMING FRAME
   0 FRAME
    
```

Procedure

GPS OPTION → LTC → TIMING → FRAME

Parameters

-29 to 0 to 29

16.1.3 Adjusting the Time Code Output Timing (Bit)

To adjust the time code outputs (LTC1 to LTC3) at the bit level, follow the procedure below. To the right of BIT, the value obtained by converting bits into time is displayed.

```
3. L T C   T I M I N G   B I T
   0 B I T       0. 0 0 0 m s
```

Procedure

GPS OPTION → LTC → TIMING → BIT

Parameters

-39 to 0 to 39

16.1.4 Adjusting the LTC2 Offset

To adjust the LTC2 offset relative to LTC1, follow the procedure below.

```
2. L T C 2   O F F S E T
+ 0 0 : 0 0 : 0 0 [ H H : M M : S S ]
```

Procedure

GPS OPTION → LTC → LTC2 OFFSET

Parameters

-23:59:59 to +00:00:00 to +23:59:59

16.1.5 Adjusting the LTC3 Offset

To adjust the LTC3 offset relative to LTC1, follow the procedure below.

```
2. L T C 3   O F F S E T
+ 0 0 : 0 0 : 0 0 [ H H : M M : S S ]
```

Procedure

GPS OPTION → LTC → LTC3 OFFSET

Parameters

-23:59:59 to +00:00:00 to +23:59:59

## 16.1.6 Setting the CW I/O

Under GPS OPTION→CW SETTING, you can set the CW I/O.



## 16.1.7 Selecting Input or Output

To select whether to use CW IN/OUT on the rear panel as an input connector or output connector, follow the procedure below.

This setting is not saved in the last memory. Even if output is selected, it will be set to input the next time you start the LT 4610. (When POWER ON RECALL on the SYSTEM menu is set to OFF)

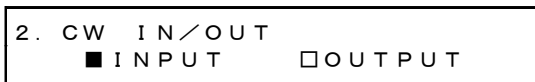

Procedure

---

GPS OPTION → CW SETTING → CW IN/OUT

---

Parameters

---

INPUT / OUTPUT

---

## 16.1.8 Selecting the Output Frequency

When CW IN/OUT is set to OUTPUT, to select the output frequency, follow the procedure below.



Procedure

---

GPS OPTION → CW SETTING → OUTPUT FREQ

---

Parameters

---

CW / 1PPS

---

## 17. GNSS OPTION MENU (SER04)

The GNSS OPTION menu is used to specify settings related to LTC output and CW I/O. You can select this option when SER04 is installed.

To display the GNSS OPTION menu, press MENU several times until the following menu appears.



### 17.1 Setting the LTC Output

Under GNSS OPTION→LTC, you can set the LTC output.



#### 17.1.1 Turing the Time Code Output On and Off

To turn the time code outputs (LTC1 to LTC3) on and off, follow the procedure below.

The time code selected in 21.7.1, "Selecting the Time Code," is output from LTC IN/OUT on the rear panel.



Procedure

---

GNSS OPTION → LTC → ON/OFF

---

Parameters

---

ON / OFF

---

#### 17.1.2 Adjusting the Time Code Output Timing (Frame)

To adjust the time code outputs (LTC1 to LTC3) at the frame level, follow the procedure below.

The adjustable range depends on the BLK1 transmission rate.



Procedure

---

GNSS OPTION → LTC → TIMING → FRAME

---

Parameters

---

-23 to 0 to 23 24Hz system, 23.98Hz system

-24 to 0 to 24 25Hz system, 50Hz system

-29 to 0 to 29 60Hz system, 59.94Hz system, 30Hz system, 29.97Hz system

---



## 17.1.3 Adjusting the Time Code Output Timing (Bit)

To adjust the time code outputs (LTC1 to LTC3) at the bit level, follow the procedure below. To the right of BIT, the value obtained by converting bits into time is displayed.

3. L T C T I M I N G B I T
<u>0</u> B I T      0. 0 0 0 m s

Procedure

---

GNSS OPTION → LTC → TIMING → BIT

---

Parameters

---

-39 to 0 to 39

---

## 17.1.4 Adjusting the LTC2 Offset

To adjust the LTC2 offset relative to LTC1, follow the procedure below.

2. L T C 2 O F F S E T
+ 0 0 : 0 0 : 0 <u>0</u> [ H H : M M : S S ]

Procedure

---

GNSS OPTION → LTC → LTC2 OFFSET

---

Parameters

---

-23:59:59 to +00:00:00 to +23:59:59

---

## 17.1.5 Adjusting the LTC3 Offset

To adjust the LTC3 offset relative to LTC1, follow the procedure below.

2. L T C 3 O F F S E T
+ 0 0 : 0 0 : 0 <u>0</u> [ H H : M M : S S ]

Procedure

---

GNSS OPTION → LTC → LTC3 OFFSET

---

Parameters

---

-23:59:59 to +00:00:00 to +23:59:59

---

## 17.1.6 Setting the CW I/O

Under GNSS OPTION→CW SETTING, you can set the CW I/O.



## 17.1.7 Selecting Input or Output

To select whether to use CW IN/OUT on the rear panel as an input connector or output connector, follow the procedure below.

This setting is not saved in the last memory. Even if output is selected, it will be set to input the next time you start the LT 4610. (When POWER ON RECALL on the SYSTEM menu is set to OFF)

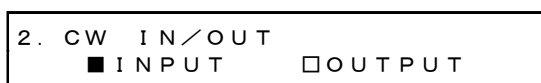

Procedure

---

GNSS OPTION → CW SETTING → CW IN/OUT

---

Parameters

---

INPUT / OUTPUT

---

## 17.1.8 Selecting the Output Frequency

When CW IN/OUT is set to OUTPUT, to select the output frequency, follow the procedure below.



Procedure

---

GNSS OPTION → CW SETTING → OUTPUT FREQ

---

Parameters

---

CW / 1PPS

---

## 18. 12G OPTION MENU (SER02)

The 12G OPTION menu is used to specify settings related to SDI output. You can select this option when SER02 is installed.

To display the 12G OPTION menu, press MENU several times until the following menu appears.

```

0. 1 2 G   O P T I O N
▼ S D I   1
  
```

On the 12G OPTION menu, you can set SDI1 to SDI4. Common settings can be specified on SDI1. On SDI2 to SDI4, different settings can be specified for groups of channels.

Note that for DUAL LINK, SDI2 and SDI4 cannot be set because only two outputs will be available. For QUAD LINK, SDI2 to SDI4 cannot be set because only one output will be available.

### 18.1 Setting the SDI Format

Under 12G OPTION→SDI 1→FORMAT, you can set the SDI signal format.

For the available combinations of SYSTEM, STRUCTURE, and RATE, see 5.4.2, "SDI Formats and Standards."

```

1. S D I   1
▼ F O R M A T
  
```

18.1.1 Selecting the System

To select the SDI signal system, follow the procedure below.

You cannot select this for SDI2 to SDI4.

Changing this setting also changes the STRUCTURE And RATE settings.



Procedure

12G OPTION → SDI 1 → FORMAT → SYSTEM

Parameters

SD	720x 487 SD / 720x 576 SD
HD	1280x 720 HD / 1920x1080 HD
HD (DL)	1920x1080 HD (DL) / 2048x1080 HD (DL)
HD(QL)	3840x2160 Square / 4096x2160 Square
3G-A	1280x 720 3G-A / 1920x1080 3G-A / 2048x1080 3G-A
3G-B-DL	1920x1080 3G-B-DL / 2048x1080 3G-B-DL
3G-B-DS Dual	1280x 720 3G-B-DS / 1920x1080 3G-B-DS
3G(DL)-A	1920x1080 3G-2K-A / 2048x1080 3G-2K-A
3G(DL)-B-DL	1920x1080 3G-2K-B / 2048x1080 3G-2K-B
3G(DL)-B-DS	3840x2160 Square / 3840x2160 2Sample / 4096x2160 Square / 4096x2160 2Sample
3G(QL)-A	3840x2160 Square / 3840x2160 2Sample / 4096x2160 Square / 4096x2160 2Sample
3G(QL)-B-DL	3840x2160 Square / 3840x2160 2Sample / 4096x2160 Square / 4096x2160 2Sample
12G	3840x2160 12G / 4096x2160 12G

## 18.1.2 Selecting the Color System

To select the SDI signal color system and quantization accuracy, follow the procedure below.

Changing this setting also changes the RATE settings.

```
3. SDI STRUCTURE
▶* 4 2 2 (YCbCr) 10-bit
```

---

 Procedure

12G OPTION → SDI 1 → FORMAT → STRUCTURE

---

## Parameters

422(YCbCr)10-bit / 422(YCbCr)12-bit / 444(YCbCr)10-bit /  
444(YCbCr)12-bit / 444(RGB)10-bit / 444(RGB)12-bit

---

## 18.1.3 Selecting the Frame Frequency

To select the SDI signal frame (field) frequency, follow the procedure below.

```
3. SDI RATE
▶* 5 9. 9 4 I
```

---

 Procedure

12G OPTION → SDI 1 → FORMAT → RATE

---

## Parameters

60P / 59.94P / 50P / 48P / 47.95P / 30P / 29.97P / 25P /  
24P / 23.98P / 30PsF / 29.97PsF / 25PsF / 24PsF / 23.98PsF / 60I / 59.94I / 50I

---

## 18.2 Adjusting the Timing

Under 12G OPTION→SDI 1→TIMING, you can adjust the SDI signal relative to the reference signal.

You can also set SDI2 to SDI4 separately.

```

1. S D I 1
  T I M I N G
  
```

### 18.2.1 Adjusting the Timing (Line)

To adjust the SDI signal relative to the reference signal at the line level, follow the procedure below.

The variable range depends on the format.

```

3. S D I 1 T I M I N G V
   0 L I N E
  
```

#### Procedure

---

12G OPTION → SDI 1 → TIMING → VERTICAL

---

#### Parameters

---

-1124 to 0 to +1124

---

### 18.2.2 Adjusting the Timing (Dot)

To adjust the SDI signal relative to the reference signal at the dot level, follow the procedure below. To the right of DOT, the value obtained by converting dots into time is displayed.

The variable range depends on the format.

```

3. S D I 1 T I M I N G H
   0 D O T      0. 0 0 0 0 μ s
  
```

#### Procedure

---

12G OPTION → SDI 1 → TIMING → HORIZONTAL

---

#### Parameters

---

-4124 to 0 to +4124

---

### 18.3 Selecting the Pattern

To select a fixed pattern or a user pattern created on a PC, follow the procedure below. To select items use the ▲, ▼, ◀, and ▶ keys.

The SDI pattern generation settings can be set separately for each output. But the fixed pattern and user pattern cannot be generated simultaneously.

#### 18.3.1 Switching between Fixed Pattern and User Pattern

To switch between fixed pattern and user pattern, follow the procedure below.



##### Procedure

---

12G OPTION → SDI 1 → PATTERN → PATTERN SELECT

---

##### Parameters

---

FIX PATTERN / USER PATTERN

---

## 18. 12G OPTION MENU (SER02)

### 18.3.2 Selecting the Fixed Pattern

To select the fixed pattern, follow the procedure below.

```
4. SDI 1 COLOR BAR
  ▾ ▶ * 1 0 0 %
```

#### Procedure

12G OPTION → SDI 1 → PATTERN → PATTERN SELECT → FIX PATTERN

#### Parameters

COLOR BAR 100% / 75% / MULTI 100% / MULTI 75% / MULTI (+I) /  
SMPTE / EBU / BBC / ARIB STD-B66-2

MONITOR FLAT FIELD 100% / FLAT FIELD 0% / RED FIELD 100% /  
GREEN FILED 100% / BLUE FIELD 100%

SDI CHECK FIELD

The selectable patterns depend on the SDI format as shown below.

Pattern		SDI format				
		Other than those on the right	720x487:SD	720x576:SD	3840x2160	4096x2160
COLOR BAR	100%	Y	Y	Y	Y	Y
	75%	Y	Y	N	Y	Y
	MULTI 100%	Y	N	N	Y	Y
	MULTI 75%	Y	N	N	Y	Y
	MULTI (+I)	Y	N	N	Y	Y
	SMPTE	N	Y	N	N	N
	EBU	N	N	Y	N	N
	BBC	N	N	Y	N	N
ARIB STD-B66-2	N	N	N	Y (*1)	L (*1, 2)	
MONITOR	-	Y	Y	Y	Y	Y
SDI	-	Y	Y	Y	N	N

(Y: Can be selected, N: Cannot be selected, L: Can be selected but a portion of the area will not display anything)

\*1 In ARIB STD-B66-2, the color system is 422(YCbCr) 10 bit.

\*2 Because ARIB STD-B66-2 is a fixed pattern that is 3840x2160 in size, 256 dots on the right side will display black if the pattern is displayed in the 4096x2160 size.



18. 12G OPTION MENU (SER02)

100%

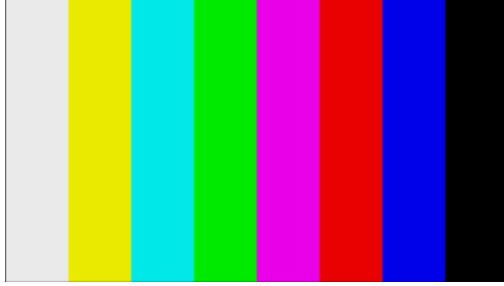

75%

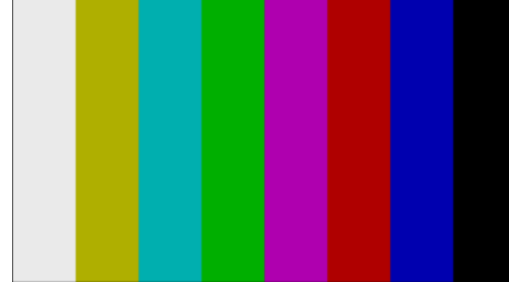

MULTI 100%



MULTI 75%



MULTI (+I)



SMPTE



EBU



BBC



18. 12G OPTION MENU (SER02)

FLAT FIELD 100%



FLAT FIELD 0%

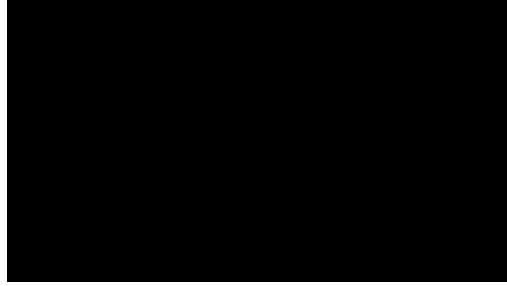

RED FIELD 100%

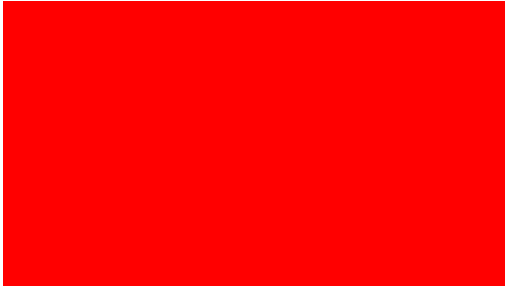

GREEN FIELD 100%

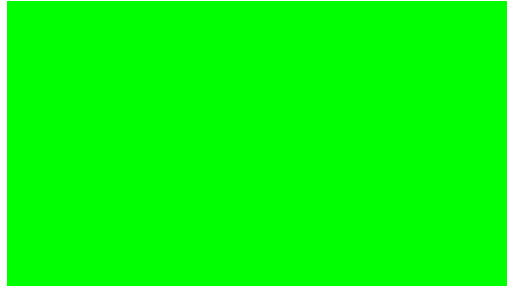

BLUE FIELD 100%

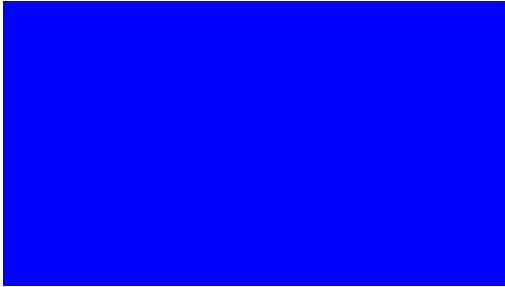

CHECK FIELD

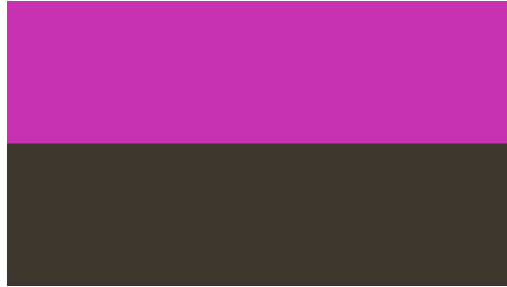

18.3.3 Operating procedure a user pattern

The following figure shows the procedure for operating a user pattern.

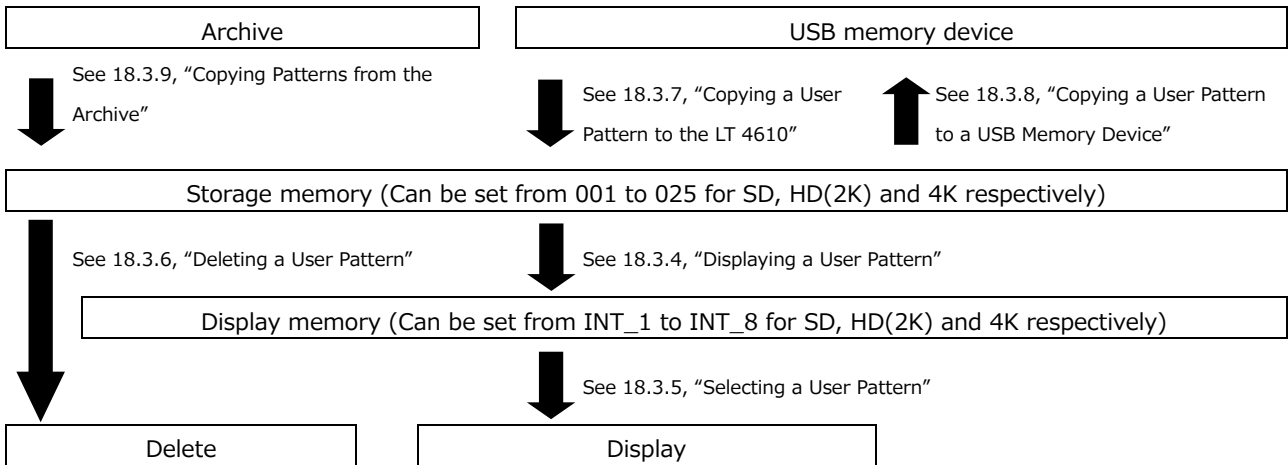

## 18.3.4 Displaying a User Pattern

This section describes the procedure for displaying a user pattern from the LT 4610 storage memory.

In this example, the user pattern file name is "LEADER.bmp," and the format is 4K.

1. Select the display memory from INT\_1 to INT\_8.

If a user pattern has already been transferred to the display memory, the selected user pattern is displayed. If no user pattern has been transferred, you need to transfer a pattern from the storage memory to the display memory.

How to save the user pattern to the storage memory, see 18.3.7, "Copying a User Pattern to the LT 4610" and 17.3.9, "Copying Patterns from the Archive."

The format is automatically set to SD, HD (2K), 4K (2SI), or 4K (SQD) according to the selected SDI format. The format is displayed as SD, 2K, 2SI, or SQD at the upper right of the USER PATTERN menu.

Therefore you need to select the SDI format before you select the user pattern.

[See also] 18.3.5, "Selecting a User Pattern", 18.3.7, "Copying a User Pattern to the LT 4610", 18.3.9, "Copying Patterns from the Archive"

```
4. USER PATTERN 1 2SI
▼ * INT 1 LEADER. bmp
```

---

#### Procedure

12G OPTION → SDI 1 → PATTERN → PATTERN SELECT → USER PATTERN

---

2. Select the storage memory from 001 to 025.

When the file in the selected display memory matches that in the storage memory, see step 3.

When the file in the selected display memory does not match that in the storage memory, see step 4.

The format is automatically set to SD, HD (2K), 4K(2SI), or 4K(SQD) according to the selected SDI format. The format is displayed as SD, 2K, 4K(2SI), or 4K(SQD) at the upper right of the USER PATTERN menu.

```
5. USER PATTERN 1 2SI
▼ 001 LEADER. bmp
```

## 18. 12G OPTION MENU (SER02)

### 3. When the file in the selected display memory matches that in the storage memory

- Select whether to display it as it is.

If you select CANCEL, you will return to selecting the storage memory.

```
SELECT FILE IS SAME.  
  ■ YES          □ CANCEL
```

- Set whether to automatically transfer the selected user pattern on the next startup.

An asterisk appears in front of the file name for the user pattern with power on load set to on.

```
6. POWER ON LOAD  
  □ YES          ■ NO
```

Example

```
4. USER PATTERN 1 2 S I  
▼ * INT 1      * LEADER. bmp
```

(When power on load is set to on)

### 4. When the file in the selected display memory does not match that in the storage memory

- Set whether to automatically transfer the selected user pattern on the next startup.

An asterisk appears in front of the file name for the user pattern with power on load set to on.

```
6. POWER ON LOAD  
  □ YES          ■ NO
```

Example

```
4. USER PATTERN 1 2 S I  
▼ * INT 1      * LEADER. bmp
```

(When power on load is set to on)

- File transfer begins. Do not turn off the power while the transfer is in progress.

In the case of a 4K user pattern, it takes about 5 minutes.

```
COPY USER PATTERN  
  ■■□□□□□□□□ 25%
```

- When the transfer is complete, the user pattern is displayed.

## 18.3.5 Selecting a User Pattern

To select a user pattern stored in the LT 4610's internal display memory, follow the procedure below. User patterns are stored in separate folders (SD, HD(2K), 4K(2SI) and 4K(SQD)) according to the SDI format.

The data in the folder corresponding to the selected SDI format is automatically displayed.

To display a user pattern, the pattern must first be transferred from the storage memory to the display memory.

```
4. USER PATTERN 1 2 S I
▼ * I N T 1      L E A D E R. b m p
```

## Procedure

---

12G OPTION → SDI 1 → PATTERN → PATTERN SELECT → USER PATTERN

---

The power on load function is available for automatically transferring a user pattern of your choice at startup. You can set this function in the procedure for transferring user patterns to memory. An asterisk appears in front of the file name for the user pattern to be transferred using power on load.

## Example

```
4. USER PATTERN 1 2 S I
▼ * I N T 1      * L E A D E R. b m p
```

(When power on load is set to on)

## 18.3.6 Deleting a User Pattern

To delete user pattern data from the LT 4610's storage memory, follow the procedure below. You can select any of the folders, regardless of the current SDI format.

In this example, the user pattern file name is "LEADER.bmp," and the format is 4K.

Procedure

---

12G OPTION → SDI 1 → PATTERN → DELETE

---

To clear a user pattern, follow the procedure below.

1. Select the format.

Select SD, HD (2K), or 4K.

```

3. DELETE PATTERN
^ 4 K                               ↵
  
```

2. Select the user patterns you want to delete from 001 to 025.

```

4. DELETE PATTERN
v 001 LEADER. bmp
  
```

3. Select the OK.

```

5. DELETE PATTERN
  ■ OK                               □ CANCEL
  
```

18.3.7 Copying a User Pattern to the LT 4610

To copy up to 25 user patterns each for SD, HD(2K), and 4K from a USB memory device to the LT 4610's storage memory, follow the procedure below. (Copy the user pattern data that you created on a PC to the USB memory device in advance.)

In this example, the user pattern file name is "LEADER.bmp," and the format is 4K.

The following menu appears when a USB memory device with the following folder structure is connected.

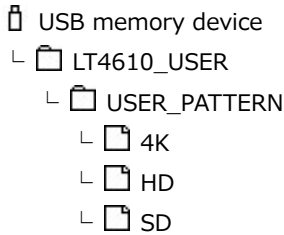

Procedure

12G OPTION → SDI 1 → PATTERN → COPY USB→INT

To copy a user pattern, follow the procedure below.

1. Select the format.

Select SD, HD(2K), or 4K.

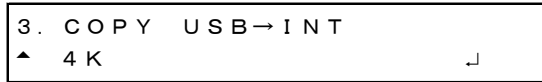

2. Select the copy source in the USB memory device.

Here, BMP, TIFF, and IMG files in the folder corresponding to the selected format in the USB memory device are displayed.

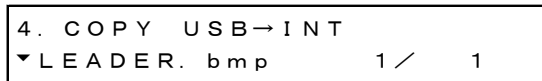

3. Select the copy destination in the LT 4610's storage memory from 001 to 025.

If there is already a user pattern stored there, it will be overwritten.

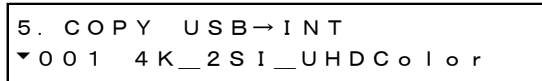

4. If a user pattern is in IMG format, copying begins.

In the case of a 4K user pattern, copying takes about 7 minutes. Do not turn the power off or remove the USB memory device while copying.





## 18. 12G OPTION MENU (SER02)

5. If the user pattern is BMP or TIFF format, set the COLORIMETRY and RANGE. Select any values of your choice.

6. COLORIMETRY
<input type="checkbox"/> 601 <input checked="" type="checkbox"/> 709 <input type="checkbox"/> 2020

7. RANGE
<input checked="" type="checkbox"/> NARROW <input type="checkbox"/> FULL

6. If the user pattern is 4K, select the division.

8. DIVISION
<input type="checkbox"/> 2SI <input checked="" type="checkbox"/> SQD

7. Copying begins.

In the case of a 4K user pattern, copying takes about 7 minutes. Do not turn the power off or remove the USB memory device while copying.

COPY USER PATTERN
<input checked="" type="checkbox"/> <input checked="" type="checkbox"/> <input type="checkbox"/> <input type="checkbox"/> <input type="checkbox"/> <input type="checkbox"/> <input type="checkbox"/> <input type="checkbox"/> <input type="checkbox"/> <input type="checkbox"/> 25%

### • USB Memory Device File Structure

User patterns are copied from the USER\_PATTERN folder of the USB memory device.

```
└─ USB memory device
  └─ LT4610_USER
    └─ USER_PATTERN
      └─ 4K
          └─ *****.bmp
      └─ HD
          └─ *****.bmp
      └─ SD
          └─ *****.bmp
```

- 4K folder:        Save image files that are 3840×2160 or 4096×2160.  
HD folder:        Save image files that are 1280×720, 1920×1080, or 2048×1080.  
SD folder:        Save image files that are 720×487 or 720×576.

18.3.8 Copying a User Pattern to a USB Memory Device

To copy user pattern data from the LT 4610's storage memory to a USB memory device, follow the procedure below.

In this example, the user pattern file name is "LEADER.bmp," and the format is 4K.

The following menu appears when a USB memory device with the following folder structure is connected.

- 📁 USB memory device
  - └─ 📁 LT4610\_USER
    - └─ 📁 USER\_PATTERN
      - └─ 📁 4K
      - └─ 📁 HD
      - └─ 📁 SD

Procedure

12G OPTION → SDI 1 → PATTERN → COPY INT→USB

To copy a user pattern, follow the procedure below.

1. Select the format.

Select SD, HD (2K), or 4K.

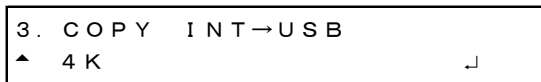

2. Select the copy source in the LT 4610's storage memory from 001 to 025.

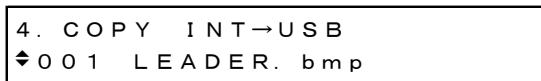

3. Select the OK.

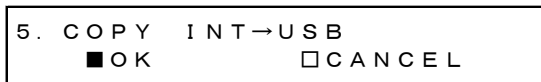

4. Copying begins.

In the case of a 4K user pattern, copying takes about 7 minutes. Do not turn the power off or remove the USB memory device while copying.



• USB Memory Device File Structure

User patterns are stored in the USER\_PATTERN folder of the USB memory device.

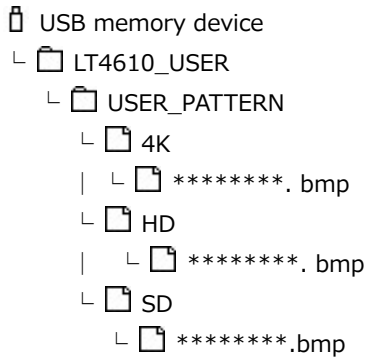

- 4K folder: Image files that are 3840×2160 or 4096×2160 are stored.
- HD folder: Image files that are 1280×720, 1920×1080, or 2048×1080 are stored.
- SD folder: Image files that are 720×487 or 720×576 are stored.

18.3.9 Copying Patterns from the Archive

To copy archived patterns to the LT 4610's storage memory, follow the procedure below. You cannot write to the archive.

In this example, the archive pattern file name is "UHDColorBar.img," and the format is 4K.

This menu appears when there are patterns in the archive.

Procedure

12G OPTION → SDI 1 → PATTERN → ARCHIVE→INT

To copy an archived pattern, follow the procedure below.

1. Select the format.

Select SD, HD (2K), or 4K.

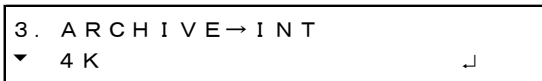

2. Select the archive copy source.

Here, IMG files in the folder corresponding to the selected format in the archive are displayed.

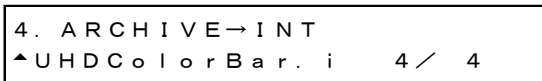

3. Select the copy destination in the LT 4610's storage memory from 001 to 025.

If there is already a user pattern stored there, it will be overwritten.

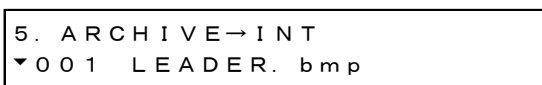

## 18. 12G OPTION MENU (SER02)

### 4. Copying begins.

In the case of a 4K user pattern, copying takes about 7 minutes. Do not turn the power off or remove the USB memory device while copying.



The following patterns can be selected in the archive.

Pattern	SDI format				
	SD	HD(2K)	4K(SQD)	4K(2SI)	8K
UHDColorBar	N	N	N	✓	✓
HLGCB	N	N	✓	✓	N
SLog3_LiveHDR_narrow_v11	N	✓	N	✓	✓

(✓: Can be selected, N: Cannot be selected)

UHDColorBar



HLGCB



SLog3\_LiveHDR\_narrow\_v111

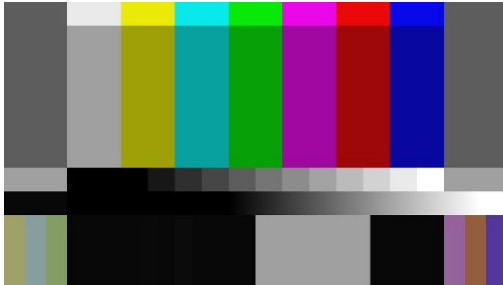

#### 18.4 Turning YCbCr On and Off

Under 12G OPTION→SDI 1→VIDEO→COMPONENT, you can turn individual components in a YCbCr or GBR signal on and off.

For the setting procedure, see 12.4, "Turning YCbCr On and Off."

#### 18.5 Turning Safety Area Markers On and Off

Under 12G OPTION→SDI 1→VIDEO→SAFETY AREA, you can turn on and off the 90% marker, 80% marker, and 4:3 marker separately.

For the setting procedure, see 12.5, "Turning Safety Area Markers On and Off."

#### 18.6 Configuring the Pattern Scroll Feature

Under 12G OPTION→SDI 1→VIDEO→SCROLL, you can configure pattern scrolling.

For the setting procedure, see 12.6, "Configuring the Pattern Scroll Feature."

#### 18.7 Setting the Pattern Change

Under 12G OPTION→SDI 1→VIDEO→PATTERN CHANGE, you can set the pattern change.

For the setting procedure, see 12.7, "Setting the Pattern Change."

#### 18.8 Setting ID Characters

Under 12G OPTION→SDI 1→VIDEO→ID CHARACTER, set the ID characters.  
You can also set SDI2 to SDI4 separately.

For the setting procedure, see 12.8, "Setting ID Characters."

#### 18.9 Setting Logos

Under 12G OPTION→SDI 1→VIDEO→LOGO, you can set the logo.  
You can also set SDI2 to SDI4 separately.

For the setting procedure, see 12.9, "Setting Logos."

## 18.10 Setting the Moving Box

Under 12G OPTION→SDI 1→VIDEO→MOVING BOX, you can set the moving box.  
This is invalid when the pattern is the user pattern or check field.



### 18.10.1 Turning the Moving Box On and Off

To turn moving box on and off, follow the procedure below.



Procedure

12G OPTION → SDI 1 → VIDEO → MOVING BOX → ON/OFF

Parameters

ON / OFF

### 18.10.2 Setting the Box Color

To set the moving box color, follow the procedure below.



Procedure

12G OPTION → SDI 1 → VIDEO → MOVING BOX → BOX COLOR

Parameters

WHITE / YELLOW / CYAN / GREEN / BLUE / RED / MAGENTA / BLACK

### 18.10.3 Setting the Vertical Moving Speed

To set the moving speed, follow the procedure below.



Procedure

12G OPTION → SDI 1 → VIDEO → MOVING BOX → V-SPEED

Parameters

LOW / MIDDLE / HIGH

## 18.10.4 Setting the Horizontal Moving Speed

To set the moving speed, follow the procedure below.

```
4. MOVING BOX H-SPEED
▶* MIDDLE
```

Procedure

12G OPTION → SDI 1 → VIDEO → MOVING BOX → H-SPEED

Parameters

LOW / MIDDLE / HIGH

## 18.10.5 Setting the Vertical Box Size

To set the vertical size of the box, follow the procedure below.

When the image size is 1280x720, you cannot select SIZE4 and SIZE5.

```
4. MOVING BOX V-SIZE
▶* SIZE2
```

Procedure

12G OPTION → SDI 1 → VIDEO → MOVING BOX → V-SIZE

Parameters

SIZE1 / SIZE2 / SIZE3 / SIZE4 / SIZE5

## 18.10.6 Setting the Horizontal Box Size

To set the horizontal size of the box, follow the procedure below.

When the image size is 1280x720, you cannot select SIZE4 and SIZE5.

```
4. MOVING BOX H-SIZE
▶* SIZE2
```

Procedure

12G OPTION → SDI 1 → VIDEO → MOVING BOX → H-SIZE

Parameters

SIZE1 / SIZE2 / SIZE3 / SIZE4 / SIZE5

### 18.11 Turning Lip Sync On and Off

To turn lip sync pattern on and off, follow the procedure below.

When turned on, the LT 4610 outputs lip sync patterns. Combining this with our lip-sync-compatible waveform monitor makes it possible to measure the offset between the video signal and the audio signal that occurs in the transfer route for each channel. For details, see the instruction manual of the waveform monitor.

For details on lip sync patterns, see 15.2, "Description of Lip Sync Patterns."

This is invalid when the SDI signal pattern is check field.



Procedure

---

12G OPTION → SDI 1 → VIDEO → LIPSYNC → ON/OFF

---

Parameters

---

ON / OFF

---

If set to ON, set all audio channels as follows under 12G OPTION→SDI 1→AUDIO for SDI signals.

These settings are factory default settings.

	Item	Setting
SDI menu	AUDIO ON/OFF	ON
	FREQ	1kHz
	LEVEL	-20
	RESOLUTION	20BIT
	EMPHASIS	OFF



### 18.12 Turning User Payload ID On and Off

To turn user payload ID on and off, follow the procedure below.

When the user pattern is selected, turning it ON outputs the user payload ID information.

You can edit the user payload ID only in a web browser.

How to edit, see 22.2.11 "Editing User Payload ID."



Procedure

---

12G OPTION → SDI 1 → VIDEO → USER PAYLOAD → ON/OFF

---

Parameters

---

ON / OFF

---

### 18.13 Configuring Embedded Audio

16 (HD(DL)) audio channels (32 channels for 3G-B) can be embedded in an SDI signal.

For the setting procedure, see 12.10, "Configuring Embedded Audio."

### 18.14 Common SDI Signal Settings

You can link the SDI2 and SDI3 settings to the SDI1 setting and the SDI4 setting to the SDI3 setting by following the procedure below to select ON.

When linked, SDI2 to SDI4 cannot be set.



Procedure

---

12G OPTION → SDI 2 → EQUAL TO SDI 1

12G OPTION → SDI 3 → EQUAL TO SDI 1

12G OPTION → SDI 4 → EQUAL TO SDI 3

---

Parameters

---

ON / OFF

---

## 19. 8K OPTION MENU (SER24)

When 8K OPTION is installed, the item are added to the 12G OPTION(SER02) menu.  
For the basic operation, See 17, "12G OPTION Menu (SER02)."

To display the 12G OPTION menu, press MENU several times until the following menu appears.



The 8K settings can be set with SDI1. When 8K is enable, SDI2 to 4 cannot be set.

### 19.1 Setting the SDI Format

Under 12G OPTION→SDI 1→FORMAT, you can set the SDI signal format.

For the available combinations of SYSTEM, STRUCTURE, and RATE, see 5.10.2, "SDI Formats and Standards."



#### 19.1.1 Selecting the System

To select the 8K 12G-SDI signal system, follow the procedure below.  
Changing this setting also changes the STRUCTURE And RATE settings.

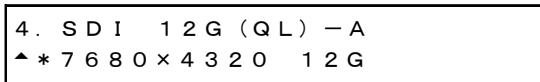

Procedure

12G OPTION → SDI 1 → FORMAT → SYSTEM → 12G

Parameters

3840x2160 12G / 4096x2160 12G / 7680x4320 12G

#### 19.1.2 Selecting the Color System

To select the SDI signal color system and quantization accuracy, follow the procedure below.

Changing this setting also changes the RATE settings.



Procedure

12G OPTION → SDI 1 → FORMAT → STRUCTURE

Parameters

422(YCbCr)10-bit / 422(YCbCr)12-bit / 444(YCbCr)10-bit /  
444(YCbCr)12-bit / 444(RGB)10-bit / 444(RGB)12-bit

19.1.3 Selecting the Frame Frequency

To select the SDI signal frame (field) frequency, follow the procedure below.

```
3. SDI RATE
▶* 59.94 I
```

Procedure

---

12G OPTION → SDI 1 → FORMAT → RATE

---

Parameters

---

60P / 59.94P / 50P / 48P / 47.95P / 30P / 29.97P / 25P / 24P / 23.98P

---

## 19.2 Adjusting the Timing

Under 12G OPTION→SDI 1→TIMING, you can adjust the SDI signal relative to the reference signal.

How to set, see 18.2, "Adjusting the Timing."

## 19.3 Selecting the Pattern

To select a fixed pattern or a user pattern created on a PC, follow the procedure below. To select items use the ▲, ▼, ◀, and ▶ keys.

The fixed pattern and user pattern cannot be generated simultaneously.

### 19.3.1 Switching between Fixed Pattern and User Pattern

To switch between fixed pattern and user pattern, follow the procedure below.



#### Procedure

12G OPTION → SDI 1 → PATTERN → PATTERN SELECT

#### Parameters

FIX PATTERN / USER PATTERN

### 19.3.2 Selecting the Fixed Pattern

To select the fixed pattern, follow the procedure below.



#### Procedure

12G OPTION → SDI 1 → PATTERN → PATTERN SELECT → FIX PATTERN

#### Parameters

COLOR BAR 100% / 75%

MONITOR FLAT FIELD 100% / FLAT FIELD 0% / RED FIELD 100% /

GREEN FILED 100% / BLUE FIELD 100%

19. 8K OPTION MENU (SER24)

100%

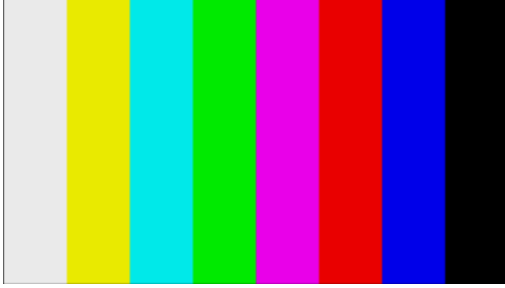

75%

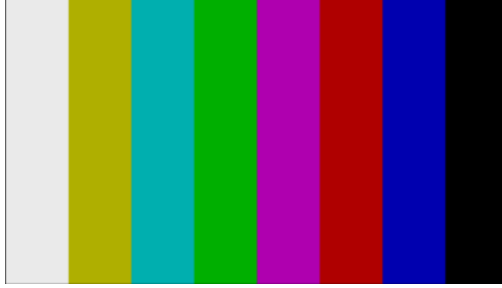

FLAT FIELD 100%

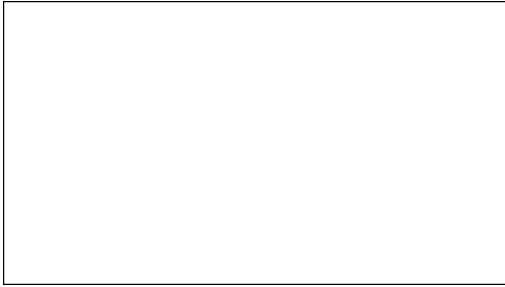

FLAT FIELD 0%



RED FIELD 100%



GREEN FIELD 100%



BLUE FIELD 100%

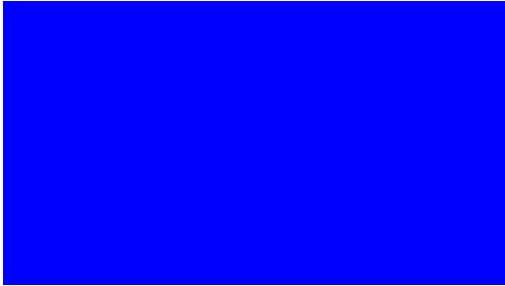

19.3.3 Operating procedure a user pattern

The following figure shows the procedure for operating a user pattern.

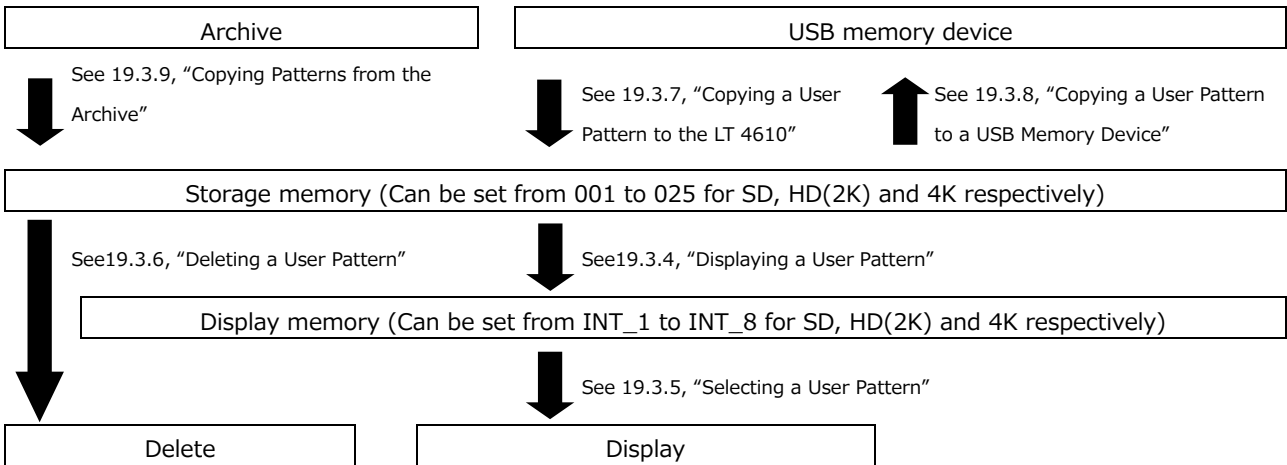

19.3.4 Displaying a User Pattern

This section describes the procedure for displaying a user pattern from the LT 4610 storage memory.

In this example, the user pattern file name is "LEADER.bmp," and the format is 4K.

1. Select the display memory from INT\_1 to INT\_8.

If a user pattern has already been transferred to the display memory, the selected user pattern is displayed. If no user pattern has been transferred, you need to transfer a pattern from the storage memory to the display memory.

How to save the user pattern to the storage memory, see 19.3.7, "Copying a User Pattern to the LT 4610" and 19.3.9, "Copying Patterns from the Archive."

The format is automatically set to SD, HD (2K), 4K(2SI), 4K(SQD) or 8K according to the selected SDI format. The format is displayed as SD, 2K, 2SI, SQD, or 8K at the upper right of the USER PATTERN menu.

You need to select the SDI format before you select the user pattern.

[See also] 19.3.5, "Selecting a User Pattern", 19.3.7, "Copying a User Pattern to the LT 4610", 19.3.9, "Copying Patterns from the Archive"

```

4 . USER PATTERN 1 8 K
▼ * I N T 1      L E A D E R . b m p
  
```

Procedure

12G OPTION → SDI 1 → PATTERN → PATTERN SELECT → USER PATTERN

## 19. 8K OPTION MENU (SER24)

2. Select the storage memory from 001 to 025.

When the file in the selected display memory matches that in the storage memory, see step 3.

When the file in the selected display memory does not match that in the storage memory, see step 4.

The format is automatically set to SD, HD (2K), 4K(2SI), 4K(SQD), 8K according to the selected SDI format. The format is displayed as SD, 2K, 4K(2SI), 4K(SQD) or 8K at the upper right of the USER PATTERN menu.

```
5. USER PATTERN 1 8K
▼ 001 LEADER. bmp
```

3. When the file in the selected display memory matches that in the storage memory

- Select whether to display it as it is.

If you select CANCEL, you will return to selecting the storage memory.

```
SELECT FILE IS SAME.
  ■ YES          □ CANCEL
```

- Set whether to automatically transfer the selected user pattern on the next startup.

An asterisk appears in front of the file name for the user pattern with power on load set to on.

```
6. POWER ON LOAD
  □ YES          ■ NO
```

Example

```
4. USER PATTERN 1 8K
▼ *INT1 *LEADER. bmp
```

(When power on load is set to on)

4. When the file in the selected display memory does not match that in the storage memory

- Set whether to automatically transfer the selected user pattern on the next startup.

An asterisk appears in front of the file name for the user pattern with power on load set to on.

```
6. POWER ON LOAD
   □ YES      ■ NO
```

Example

```
4. USER PATTERN 1 8K
▼ * INT1 * LEADER. bmp
```

(When power on load is set to on)

- File transfer begins. Do not turn off the power while the transfer is in progress.

In the case of a 4K user pattern, it takes about 15 minutes.

```
 COPY USER PATTERN
   ■ ■ □ □ □ □ □ □ □ □ 25%
```

- When the transfer is complete, the user pattern is displayed.

### 19.3.5 Selecting a User Pattern

To select a user pattern stored in the LT 4610's internal display memory, follow the procedure below. User patterns are stored in separate folders (SD, HD(2K), 4K(2SI) 4K(SQD), and 8K) according to the SDI format.

The data in the folder corresponding to the selected SDI format is automatically displayed.

To display a user pattern, the pattern must first be transferred from the storage memory to the display memory.

```
4. USER PATTERN 1 8K
▼ * INT1 LEADER. bmp
```

Procedure

---

12G OPTION → SDI 1 → PATTERN → PATTERN SELECT → USER PATTERN

---

The power on load function is available for automatically transferring a user pattern of your choice at startup. You can set this function in the procedure for transferring user patterns to memory. An asterisk appears in front of the file name for the user pattern to be transferred using power on load.

Example

```
4. USER PATTERN 1 8K
▼ * INT1 * LEADER. bmp
```

(When power on load is set to on)



## 19.3.6 Deleting a User Pattern

To delete user pattern data from the LT 4610's storage memory, follow the procedure below. You can select any of the folders, regardless of the current SDI format. In this example, the user pattern file name is "LEADER.bmp," and the format is 8K.

## Procedure

---

12G OPTION → SDI 1 → PATTERN → DELETE

---

To clear a user pattern, follow the procedure below.

1. Select the format.

Select SD, HD (2K), 4K, or 8K.

```

3.  D E L E T E   P A T T E R N
^   8 K
  
```

2. Select the user patterns you want to delete from 001 to 025.

```

4.  D E L E T E   P A T T E R N
v  0 0 1   L E A D E R .   b m p
  
```

3. Select the OK.

```

5.  D E L E T E   P A T T E R N
    ■ O K           □ C A N C E L
  
```

19.3.7 Copying a User Pattern to the LT 4610

To copy up to 25 user patterns each for SD, HD(2K), 4K, and 8K from a USB memory device to the LT 4610's storage memory, follow the procedure below. (Copy the user pattern data that you created on a PC to the USB memory device in advance.)

In this example, the user pattern file name is "LEADER.bmp," and the format is 8K.

The following menu appears when a USB memory device with the following folder structure is connected.

```

USB memory device
├── LT4610_USER
│   ├── USER_PATTERN
│   │   ├── 8K
│   │   ├── 4K
│   │   ├── HD
│   │   └── SD
    
```

Procedure

12G OPTION → SDI 1 → PATTERN → COPY USB→INT

To copy a user pattern, follow the procedure below.

1. Select the format.

Select SD, HD(2K), 4K, or 8K.

```

3. COPY USB→INT
▲ 8K
    
```

2. Select the copy source in the USB memory device.

Here, BMP, TIFF, and IMG files in the folder corresponding to the selected format in the USB memory device are displayed.

```

4. COPY USB→INT
▼ LEADER. bmp 1 / 1
    
```

3. Select the copy destination in the LT 4610's storage memory from 001 to 025.

If there is already a user pattern stored there, it will be overwritten.

```

5. COPY USB→INT
▼ 001 4K_2SI_UHDC o l o r
    
```

4. If a user pattern is in IMG format, copying begins.

In the case of a 8K user pattern, copying takes about 15 minutes. Do not turn the power off or remove the USB memory device while copying.

```

COPY USER PATTERN
■■■■■■■■■■ 25%
    
```

## 19. 8K OPTION MENU (SER24)

5. If the user pattern is BMP or TIFF format, set the COLORIMETRY, RANGE, and HDR/SDR. Select any values of your choice.

6. COLORIMETRY <input type="checkbox"/> 601 <input checked="" type="checkbox"/> 709 <input type="checkbox"/> 2020
--

7. RANGE <input checked="" type="checkbox"/> NARROW <input type="checkbox"/> FULL
--

8. HDR / SDR <input checked="" type="checkbox"/> SDR <input type="checkbox"/> HLG <input type="checkbox"/> PQ <input type="checkbox"/> Unspc
---

6. Copying begins.

In the case of an 8K user pattern, copying takes about 15 minutes. Do not turn the power off or remove the USB memory device while copying.

COPY USER PATTERN <input checked="" type="checkbox"/> <input checked="" type="checkbox"/> <input type="checkbox"/> <input type="checkbox"/> <input type="checkbox"/> <input type="checkbox"/> <input type="checkbox"/> <input type="checkbox"/> <input type="checkbox"/> <input type="checkbox"/> 25%
--

### • USB Memory Device File Structure

User patterns are copied from the USER\_PATTERN folder of the USB memory device.

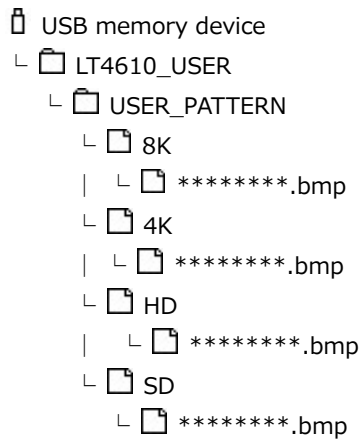

- 8K folder:      Save image files that are 7680×4320.  
4K folder:      Save image files that are 3840×2160 or 4096×2160.  
HD folder:      Save image files that are 1280×720, 1920×1080, or 2048×1080.  
SD folder:      Save image files that are 720×487 or 720×576.

19.3.8 Copying a User Pattern to a USB Memory Device

To copy user pattern data from the LT 4610’s storage memory to a USB memory device, follow the procedure below. However, the data converted to an IMG file is copied to a USB memory device.

In this example, the user pattern file name is “LEADER.bmp,” and the format is 4K.

The following menu appears when a USB memory device with the following folder structure is connected.

- 📁 USB memory device
  - └─ 📁 LT4610\_USER
    - └─ 📁 USER\_PATTERN
      - └─ 📁 8K
      - └─ 📁 4K
      - └─ 📁 HD
      - └─ 📁 SD

Procedure

---

12G OPTION → SDI 1 → PATTERN → COPY INT→USB

---

To copy a user pattern, follow the procedure below.

1. Select the format.

Select SD, HD (2K), 4K, or 8K.

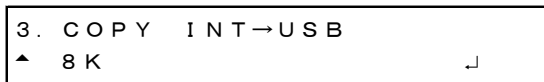

2. Select the copy source in the LT 4610’s storage memory from 001 to 025.

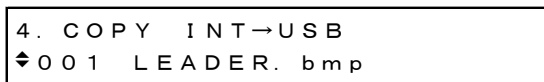

3. Select the OK.

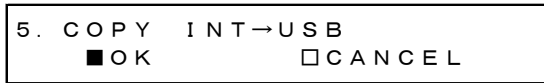

4. Copying begins.

In the case of an 8K user pattern, copying takes about 15 minutes. Do not turn the power off or remove the USB memory device while copying.



• USB Memory Device File Structure

User patterns are stored in the USER\_PATTERN folder of the USB memory device.

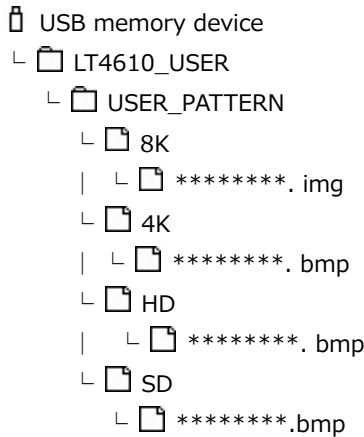

- 8K folder: Image files that are 3840×2160 or 4096×2160 are stored.
- 4K folder: Image files that are 3840×2160 or 4096×2160 are stored.
- HD folder: Image files that are 1280×720, 1920×1080, or 2048×1080 are stored.
- SD folder: Image files that are 720×487 or 720×576 are stored.

19.3.9 Copying Patterns from the Archive

To copy archived patterns to the LT 4610's storage memory, follow the procedure below. You cannot write to the archive.

In this example, the archive pattern file name is "UHDColorBar.img," and the format is 8K.

This menu appears when there are patterns in the archive.

Procedure

---

12G OPTION → SDI 1 → PATTERN → ARCHIVE→INT

---

To copy an archived pattern, follow the procedure below.

1. Select the format.

Select SD, HD (2K), 4K, or 8K.

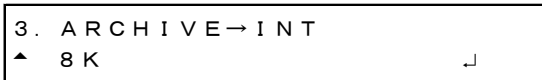

2. Select the archive copy source.

Here, BMP, TIFF, and IMG files in the folder corresponding to the selected format in the archive are displayed.

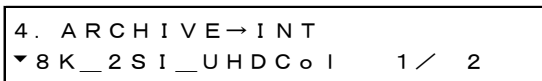

3. Select the copy destination in the LT 4610's storage memory from 001 to 025.

If there is already a user pattern stored there, it will be overwritten.

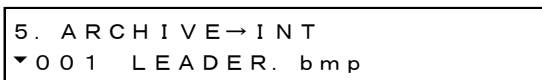

## 19. 8K OPTION MENU (SER24)

4. If a user pattern is in IMG format, Copying begins.

In the case of an 8K user pattern, copying takes about 15 minutes. Do not turn the power off or remove the USB memory device while copying.



### 19.4 Turning YCbCr On and Off

Under 12G OPTION→SDI 1→VIDEO→COMPONENT, you can turn individual components in a YCbCr or GBR signal on and off.

For the setting procedure, see 12.4, "Turning YCbCr On and Off."

### 19.5 Turning Safety Area Markers On and Off

Under 12G OPTION→SDI 1→VIDEO→SAFETY AREA, you can turn on and off the 90% marker, 80% marker, and 4:3 marker separately.

For the setting procedure, see 12.5, "Turning Safety Area Markers On and Off."

### 19.6 Configuring the Pattern Scroll Feature

Under 12G OPTION→SDI 1→VIDEO→SCROLL, you can configure pattern scrolling.

For the setting procedure, see 12.6, "Configuring the Pattern Scroll Feature."

### 19.7 Setting the Pattern Change

Under 12G OPTION→SDI 1→VIDEO→PATTERN CHANGE, you can set the pattern change.

For the setting procedure, see 12.7, "Setting the Pattern Change."

### 19.8 Setting the Moving Box

Under 12G OPTION→SDI 1→VIDEO→MOVING BOX, you can set the moving box.

For the setting procedure, see 18.10, "Setting the Moving Box."

### 19.9 Turning Lip Sync On and Off

Under 12G OPTION→SDI 1→VIDEO→LIPSYNC, you can turn the lip sync pattern on and off.

For the setting procedure, see 18.11, "Turning Lip Sync On and Off."

### 19.10 Turning User Payload ID On and Off

Under 12G OPTION→SDI 1→VIDEO→USER PAYLAD, you can turn the user payload ID on and off.

For the setting procedure, see 18.12, "Turning User Payload ID On and Off."

### 19.11 Configuring Embedded Audio

16 audio channels can be embedded in an SDI signal.

For the setting procedure, see 12.10, "Configuring Embedded Audio."

## 20. PTP OPTION MENU (SER03)

The PTP OPTION menu is used to specify PTP settings. You can select this option when SER03 is installed.

To display the PTP OPTION menu, press MENU several times until the following menu appears.

```

0. P T P   O P T I O N
▼ P T P 1
    
```

### 20.1 PTP Master

To enable PTP master mode, set the genlock mode to a value other than PTP.

[See also] 10, "GENLOCK MENU"

When configuring PTP2, for parameters without descriptions for PTP2, set them the same as PTP1.

#### 20.1.1 Setting the Mode

Under PTP OPTION→PTP1→MODE, you can enable or disable the PTP master.

```

2. P T P 1   M O D E
 * E N A B L E   M A S T E R
    
```

Procedure

PTP OPTION → PTP1 → MODE

Parameters (for PTP1)

ENABLE MASTER / DISABLE MASTER

Parameters (for PTP2)

ENABLE MASTER / DISABLE MASTER

#### 20.1.2 Setting the BMCA

Under PTP OPTION→PTP1→BMCA, you can enable or disable the BMCA.

```

2. P T P 1   B M C A
◆ * E N A B L E
    
```

Procedure

PTP OPTION → PTP1 → BMCA

Parameters

ENABLE / DISABLE



20.1.3 Setting the Profile Type

Under PTP OPTION→PTP1→PROFILE TYPE, you can select the profile.



Procedure

---

PTP OPTION → PTP1 → PROFILE TYPE

---

Parameters

---

ST2059 / AES67 / GENERAL

---

20.1.4 Profile Default Settings

PTP OPTION→PTP1→DETAIL SETTING→PROFILE SET DEFAULT can be used to reset the settings to the default values of the selected profile.



Procedure

---

PTP OPTION → PTP1 → DETAIL SETTING → PROFILE SET DEFAULT

---

20.1.5 Setting the Domain

Under PTP OPTION→PTP1→DETAIL SETTING→DOMAIN, you can set the domain number.



Procedure

---

PTP OPTION → PTP1 → DETAIL SETTING → DOMAIN

---

Parameters (when configuring PTP1 and PROFILE TYPE is ST2059)

---

0 to 127

---

Parameters (when configuring PTP2 and PROFILE TYPE is ST2059)

---

0 to 126 to 127

---

Parameters (when PROFILE TYPE is AES67)

---

0 to 255

---

Parameters (when PROFILE TYPE is GENERAL)

---

0 to 255

---

20.1.6 Setting the Communication Mode

Under PTP OPTION→PTP1→DETAIL SETTING→COMMUNICATION MODE, you can set the communication mode.

<p>3. P T P 1 C O M M U N I C A T I O N          ◀▶ * M I X E D S M P T E w / o N E</p>
---

Procedure

---

PTP OPTION → PTP1 → DETAIL SETTING → COMMUNICATION MODE

---

Parameters (when PROFILE TYPE is ST2059)

---

MIXED SMPTE / MIXED SMPTE w/o NE / UNICAST / MULTICAST

---

Parameters (when PROFILE TYPE is AES67)

---

UNICAST / MULTICAST

---

Parameters (when PROFILE TYPE is GENERAL)

---

UNICAST / MULTICAST

---

20.1.7 Setting the Announce Interval

Under PTP OPTION→PTP1→DETAIL SETTING→ANNOUNCE INTERVAL, you can set the transmission interval of announce messages.

```
3. P T P 1   A N N O U N C E   I N T
◀▶ * 0. 2 5 s           4 H z
```

Procedure

PTP OPTION → PTP1 → DETAIL SETTING → ANNOUNCE INTERVAL

Parameters (when PROFILE TYPE is ST2059)

0.125s 8Hz / 0.25s 4Hz / 0.5s 2Hz / 1s 1Hz / 2s 0.5Hz

Parameters (when PROFILE TYPE is AES67)

1s 1Hz / 2s 0.5Hz / 4s 0.25Hz / 8s 0.125Hz / 16s 0.0625Hz

Parameters (when PROFILE TYPE is GENERAL)

0.125s 8Hz / 0.25s 4Hz / 0.5s 2Hz / 1s 1Hz / 2s 0.5Hz / 4s 0.25Hz /  
8s 0.125Hz / 16s 0.0625Hz

20.1.8 Setting the Sync Interval

Under PTP OPTION→PTP1→DETAIL SETTING→SYNC INTERVAL, you can set the transmission interval of sync messages.

```
3. P T P 1   S Y N C   I N T E R V A L
◀▶ * 0. 1 2 5 s           8 H z
```

Procedure

PTP OPTION → PTP1 → DETAIL SETTING → SYNC INTERVAL

Parameters (when PROFILE TYPE is ST2059)

0.0078s 128Hz / 0.015s 64Hz / 0.0312s 32Hz / 0.0625s 16Hz / 0.125s 8Hz /  
0.25s 4Hz / 0.5s 2Hz

Parameters (when PROFILE TYPE is AES67)

0.0625s 16Hz / 0.125s 8Hz / 0.25s 4Hz / 0.5s 2Hz / 1s 1Hz

Parameters (when PROFILE TYPE is GENERAL)

0.125s 8Hz / 0.25s 4Hz / 0.5s 2Hz / 1s 1Hz / 2s 0.5Hz / 4s 0.25Hz /  
8s 0.125Hz / 16s 0.0625Hz

## 20. PTP OPTION MENU (SER03)

### 20.1.9 Setting Priority 1

Under PTP OPTION→PTP1→DETAIL SETTING→PRIORITY1, you can set the master priority 1.

```
3. P T P 1 P R I O R I T Y 1
   1 2 8
```

#### Procedure

PTP OPTION → PTP1 → DETAIL SETTING → PRIORITY1

#### Parameters

0 to 128 to 255

### 20.1.10 Setting Priority 2

Under PTP OPTION→PTP1→DETAIL SETTING→PRIORITY2, you can set the master priority 2.

```
3. P T P 1 P R I O R I T Y 2
   1 2 8
```

#### Procedure

PTP OPTION → PTP1 → DETAIL SETTING → PRIORITY2

#### Parameters

0 to 128 to 255

### 20.1.11 Setting the Step

Under PTP OPTION→PTP1→DETAIL SETTING→STEP, you can set the step.

```
3. P T P 1 S T E P
♦ * O N E S T E P
```

#### Procedure

PTP OPTION → PTP1 → DETAIL SETTING → STEP

#### Parameters

ONE STEP: Timestamps are included in sync messages.

TWO STEP: Timestamps are sent in follow-up messages, separate from sync messages.

20.1.12 Setting ST2059 (PROFILE: ST2059 only)

PTP OPTION→PTP1→DETAIL SETTING→ST2059, you can set the details when the profile is set to ST2059.

- Setting the Default Frame

Under PTP OPTION→PTP1→DETAIL SETTING→ST2059→DEFAULT FRAME, you can set the default frame.

```
4. P T P 1   S T 2 0 5 9
▶* F R A M E : 2 9 . 9 7      ↵
```

Procedure

---

PTP OPTION → PTP1 → DETAIL SETTING → ST2059 → DEFAULT FRAME

---

Parameters

---

23.98 / 24 / 25 / 29.97 / 30 / 47.95 / 48 / 50 / 59.94 / 60 / 71.92 /  
72 / 100 / 119.9 / 120

---

- Setting the Dropped Frame Flag

Under PTP OPTION→PTP1→DETAIL SETTING→ST2059→DROP FRAME FLAG, you can set the dropped frame flag.

```
4. P T P 1   S T 2 0 5 9
▶* D R O P   F R A M E : E N A B L E ↵
```

Procedure

---

PTP OPTION → PTP1 → DETAIL SETTING → ST2059 → DROP FRAME FLAG

---

Parameters

---

ENABLE / DISABLE / AUTO

---

- Setting the Color Frame ID

Under PTP OPTION→PTP1→DETAIL SETTING→ST2059→COLOR FRAME ID, you can set the color frame ID.

```
4. P T P 1   S T 2 0 5 9
▶* C F I D : E N A B L E      ↵
```

Procedure

---

PTP OPTION → PTP1 → DETAIL SETTING → ST2059 → COLOR FRAME ID

---

Parameters

---

ENABLE / DISABLE

---

20.1.13 Setting the Announce Timeout

PTP OPTION→PTP1→DETAIL SETTING→ANNOUNCE TIMEOUT can be used to set the announce message count for deciding timeouts. If the number of messages not received consecutively at the interval specified by the master reaches this count, a timeout occurs.

```
3. PTP1 ANNOUNCE
   TIMEOUT COUNT : 3
```

Procedure

---

PTP OPTION → PTP1 → DETAIL SETTING → ANNOUNCE TIMEOUT

---

Parameters

---

2 to 3 to 10

---

20.1.14 Setting the Propagation Time Measurement Method

Under PTP OPTION→PTP1→DETAIL SETTING→DELAY MECHANISM, you can set the propagation time measurement method.

```
3. PTP1 DELAY MECH
  ◀▶ * END TO END      ⌋
```

Procedure

---

PTP OPTION → PTP1 → DETAIL SETTING → DELAY MECHANISM

---

Parameters

---

END TO END / PEER TO PEER

---

## 20.2 PTP Slave

To enable PTP slave mode, set the genlock mode to PTP.

[See also] 10, "GENLOCK MENU"

PTP2 cannot be set to PTP slave.

### 20.2.1 Setting the Mode

PTP OPTION→PTP1→MODE is fixed to PTP slave.

```
2. P T P 1  M O D E
↳ * S L A V E ↵
```

Procedure

---

PTP OPTION → PTP1 → MODE

---

Parameters (when the genlock mode is PTP)

---

SLAVE

---

### 20.2.2 Setting the Profile Type

Under PTP OPTION→PTP1→PROFILE TYPE, you can select the profile.

```
2. P T P 1  P R O F I L E  T Y P E
▼ * S T 2 0 5 9 ↵
```

Procedure

---

PTP OPTION → PTP1 → PROFILE TYPE

---

Parameters

---

ST2059 / AES67 / GENERAL

---

### 20.2.3 Profile Default Settings

PTP OPTION→PTP1→DETAIL SETTING→PROFILE SET DEFAULT can be used to reset the settings to the default values of the selected profile.

```
3. P T P 1  P R O F I L E
   E N T E R  T O  D E F A U L T
```

Procedure

---

PTP OPTION → PTP1 → DETAIL SETTING → PROFILE SET DEFAULT

---

## 20.2.4 Setting the Domain

Under PTP OPTION→PTP1→DETAIL SETTING→DOMAIN, you can set the domain number.

3 . P T P 1   D O M A I N 1 2 7
------------------------------------

Procedure

---

PTP OPTION → PTP1 → DETAIL SETTING → DOMAIN

---

Parameters (when PROFILE TYPE is ST2059)

---

0 to 127

---

Parameters (when PROFILE TYPE is AES67)

---

0 to 255

---

Parameters (when PROFILE TYPE is GENERAL)

---

0 to 255

---

## 20.2.5 Setting the Communication Mode

Under PTP OPTION→PTP1→DETAIL SETTING→COMMUNICATION MODE, you can set the communication mode.

3 . P T P 1   C O M M U N I C A T I O N ◆◆ * M U L T I C A S T
---

Procedure

---

PTP OPTION → PTP1 → DETAIL SETTING → COMMUNICATION MODE

---

Parameters (when PROFILE TYPE is ST2059)

---

MIXED SMPTE / MIXED SMPTE w/o NE / UNICAST / MULTICAST

---

Parameters (when PROFILE TYPE is AES67)

---

UNICAST / MULTICAST

---

Parameters (when PROFILE TYPE is GENERAL)

---

UNICAST / MULTICAST

---



## 20. PTP OPTION MENU (SER03)

### 20.2.6 Setting the Desired Announce Message Transmission Interval (UNICAST only)

PTP OPTION→PTP1→DETAIL SETTING→ANNOUNCE DESIR INT can be used to set the desired interval of announce messages sent from the connected master.

3 . P T P 1 A N C D E S I R I N T
◀▶* 0 . 2 5 s 4 H z

#### Procedure

PTP OPTION → PTP1 → DETAIL SETTING → ANNOUNCE DESIR INT

#### Parameters (when PROFILE TYPE is ST2059)

0.125s 8Hz / 0.25s 4Hz / 0.5s 2Hz / 1s 1Hz / 2s 0.5Hz

#### Parameters (when PROFILE TYPE is AES67)

1s 1Hz / 2s 0.5Hz / 4s 0.25Hz / 8s 0.125Hz / 16s 0.0625Hz

#### Parameters (when PROFILE TYPE is GENERAL)

0.125s 8Hz / 0.25s 4Hz / 0.5s 2Hz / 1s 1Hz / 2s 0.5Hz / 4s 0.25Hz /  
8s 0.125Hz / 16s 0.0625Hz

\* Set a shorter interval than ANC REQD INT (20.2.7).

### 20.2.7 Setting the Minimum Interval for Receiving Announce Messages (UNICAST only)

PTP OPTION→PTP1→DETAIL SETTING→ANNOUNCE REQD INT can be used to set the minimum interval that the slave side can receive announce messages.

3 . P T P 1 A N C R E Q D I N T
◀▶* 2 s 0 . 5 H z

#### Procedure

PTP OPTION → PTP1 → DETAIL SETTING → ANNOUNCE REQD INT

#### Parameters (when PROFILE TYPE is ST2059)

0.125s 8Hz / 0.25s 4Hz / 0.5s 2Hz / 1s 1Hz / 2s 0.5Hz

#### Parameters (when PROFILE TYPE is AES67)

1s 1Hz / 2s 0.5Hz / 4s 0.25Hz / 8s 0.125Hz / 16s 0.0625Hz

#### Parameters (when PROFILE TYPE is GENERAL)

0.125s 8Hz / 0.25s 4Hz / 0.5s 2Hz / 1s 1Hz / 2s 0.5Hz / 4s 0.25Hz /  
8s 0.125Hz / 16s 0.0625Hz

## 20.2.8 Setting the Desired Sync Message Transmission Interval (UNICAST only)

PTP OPTION→PTP1→DETAIL SETTING→SYNC DESIR INT can be used to set the desired interval of sync messages sent from the connected master.

3 . P T P 1 S Y N D E S I R I N T
◀▶ * 0 . 1 2 5 s 8 H z

## Procedure

---

PTP OPTION → PTP1 → DETAIL SETTING → SYNC DESIR INT

---

## Parameters (when PROFILE TYPE is ST2059)

---

0.0078s 128Hz / 0.015s 64Hz / 0.0312s 32Hz / 0.0625s 16Hz / 0.125s 8Hz /  
0.25s 4Hz / 0.5s 2Hz

---

## Parameters (when PROFILE TYPE is AES67)

---

0.0625s 16Hz / 0.125s 8Hz / 0.25s 4Hz / 0.5s 2Hz / 1s 1Hz / 2s 0.5Hz

---

## Parameters (when PROFILE TYPE is GENERAL)

---

0.0078s 128Hz / 0.015s 64Hz / 0.0312s 32Hz / 0.0625s 16Hz / 0.125s 8Hz /  
0.25s 4Hz / 0.5s 2Hz / 1s 1Hz / 2s 0.5Hz / 4s 0.25Hz / 8s 0.125Hz

---

\* Set a shorter interval than SYNC REQD INT (20.2.9).

## 20.2.9 Setting the Minimum Interval for Receiving Sync Messages (UNICAST only)

PTP OPTION→PTP1→DETAIL SETTING→SYNC REQD INT can be used to set the minimum interval that the slave side can receive sync messages.

3 . P T P 1 S Y N R E Q D I N T
◀▶ * 0 . 5 s 2 H z

## Procedure

---

PTP OPTION → PTP1 → DETAIL SETTING → SYNC REQD INT

---

## Parameters (when PROFILE TYPE is ST2059)

---

0.0078s 128Hz / 0.015s 64Hz / 0.0312s 32Hz / 0.0625s 16Hz / 0.125s 8Hz /  
0.25s 4Hz / 0.5s 2Hz

---

## Parameters (when PROFILE TYPE is AES67)

---

0.0625s 16Hz / 0.125s 8Hz / 0.25s 4Hz / 0.5s 2Hz / 1s 1Hz / 2s 0.5Hz

---

## Parameters (when PROFILE TYPE is GENERAL)

---

0.0078s 128Hz / 0.015s 64Hz / 0.0312s 32Hz / 0.0625s 16Hz / 0.125s 8Hz /  
0.25s 4Hz / 0.5s 2Hz / 1s 1Hz / 2s 0.5Hz / 4s 0.25Hz / 8s 0.125Hz

---

## 20. PTP OPTION MENU (SER03)

### 20.2.10 Setting the Delay Message Interval (MULTICAST, MIXED SMPTE w/o NEGOTIATION)

PTP OPTION→PTP1→DETAIL SETTING→DELAY MSG INTERVAL can be used to set the transmission interval of delay messages.

3 . P T P 1 D E L A Y M S G I N T ◀▶* 0 . 1 2 5 s                      8 H z
---

#### Procedure

---

PTP OPTION → PTP1 → DETAIL SETTING → DELAY MSG INTERVAL

---

#### Parameters (when PROFILE TYPE is ST2059)

---

0.0078s 128Hz / 0.015s 64Hz / 0.0312s 32Hz / 0.0625s 16Hz / 0.125s 8Hz /  
0.25s 4Hz / 0.5s 2Hz

---

#### Parameters (when PROFILE TYPE is AES67)

---

0.125s 8Hz / 0.25s 4Hz / 0.5s 2Hz / 1s 1Hz / 2s 0.5Hz / 4s 0.25Hz /  
8s 0.125Hz / 16s 0.0625Hz

---

#### Parameters (when PROFILE TYPE is GENERAL)

---

0.0078s 128Hz / 0.015s 64Hz / 0.0312s 32Hz / 0.0625s 16Hz / 0.125s 8Hz /  
0.25s 4Hz / 0.5s 2Hz / 1s 1Hz / 2s 0.5Hz / 4s 0.25Hz / 8s 0.125Hz / 16s 0.0625Hz

---

### 20.2.11 Setting the Desired Delay Response Transmission Interval (Mixed SMPTE, UNICAST)

PTP OPTION→PTP1→DETAIL SETTING→DLY MSG DESIRED INT can be used to set the desired interval of delay messages sent from the connected master.

3 . P T P 1 D L Y D E S I R I N T ◀▶* 0 . 1 2 5 s                      8 H z
---

#### Procedure

---

PTP OPTION → PTP1 → DETAIL SETTING → DLY MSG DESIRED INT

---

#### Parameters (when PROFILE TYPE is ST2059)

---

0.0078s 128Hz / 0.015s 64Hz / 0.0312s 32Hz / 0.0625s 16Hz / 0.125s 8Hz /  
0.25s 4Hz / 0.5s 2Hz

---

#### Parameters (when PROFILE TYPE is AES67)

---

0.125s 8Hz / 0.25s 4Hz / 0.5s 2Hz / 1s 1Hz / 2s 0.5Hz / 4s 0.25Hz /  
8s 0.125Hz / 16s 0.0625Hz

---

#### Parameters (when PROFILE TYPE is GENERAL)

---

0.0078s 128Hz / 0.015s 64Hz / 0.0312s 32Hz / 0.0625s 16Hz / 0.125s 8Hz /  
0.25s 4Hz / 0.5s 2Hz / 1s 1Hz / 2s 0.5Hz / 4s 0.25Hz / 8s 0.125Hz / 16s 0.0625Hz

---

## 20. PTP OPTION MENU (SER03)

### 20.2.12 Setting the Minimum Interval for Receiving Delay Responses (Mixed SMPTE, UNICAST)

PTP OPTION→PTP1→DETAIL SETTING→DLY MSG REQD INT can be used to set the minimum interval that the slave side can receive delay responses.

```
3. PTP1 DLY REQD INT
◀▶* 0.5s 2Hz
```

#### Procedure

PTP OPTION → PTP1 → DETAIL SETTING → DLY MSG REQD INT

#### Parameters (when PROFILE TYPE is ST2059)

0.0078s 128Hz / 0.015s 64Hz / 0.0312s 32Hz / 0.0625s 16Hz / 0.125s 8Hz /  
0.25s 4Hz / 0.5s 2Hz

#### Parameters (when PROFILE TYPE is AES67)

0.125s 8Hz / 0.25s 4Hz / 0.5s 2Hz / 1s 1Hz / 2s 0.5Hz / 4s 0.25Hz /  
8s 0.125Hz / 16s 0.0625Hz

#### Parameters (when PROFILE TYPE is GENERAL)

0.0078s 128Hz / 0.015s 64Hz / 0.0312s 32Hz / 0.0625s 16Hz / 0.125s 8Hz /  
0.25s 4Hz / 0.5s 2Hz / 1s 1Hz / 2s 0.5Hz / 4s 0.25Hz / 8s 0.125Hz / 16s 0.0625Hz

### 20.2.13 Setting the Announce Timeout

PTP OPTION→PTP1→DETAIL SETTING→ANNOUNCE TIMEOUT can be used to set the announce message count for deciding timeouts. If the number of consecutive messages not received at the interval specified by the master reaches the specified value, a timeout occurs.

```
3. PTP1 ANNOUNCE
TIMEOUT COUNT : 3
```

#### Procedure

PTP OPTION → PTP1 → DETAIL SETTING → ANNOUNCE TIMEOUT

#### Parameters

2 to 3 to 10

## 20.2.14 Setting the Propagation Time Measurement Method

Under PTP OPTION→PTP1→DETAIL SETTING→DELAY MECHANISM, you can set the propagation time measurement method.

```
3. PTP1 DELAY MECH
◀▶*END TO END  ⏏
```

## Procedure

---

 PTP OPTION → PTP1 → DETAIL SETTING → DELAY MECHANISM
 

---

## Parameters

---

 END TO END / PEER TO PEER
 

---

## 20.2.15 Setting the IP Address of the Master to Connect To (Mixed SMPTE w/o Negotiation, UNICAST)

PTP OPTION→PTP1→DETAIL SETTING→AMT CONFIGURATION can be used to set the IP address of the master to connect to.

```
4. PTP1 AMT ADDRESS 1
◆ 000.000.000.000
```

## Procedure

---

 PTP OPTION → PTP1 → DETAIL SETTING → AMT CONFIGURATION
 

---

## Parameters

---

 000.000.000.000 to 255.255.255.255
 

---

## 20.2.16 Setting the Asymmetric Delay

PTP OPTION→PTP1→DETAIL SETTING→ASYMMETRIC DELAY can be used to adjust the phase.

```
3. PTP1 ASYM DELAY
    00.000 usec
```

## Procedure

---

 PTP OPTION → PTP1 → DETAIL SETTING → ASYMMETRIC DELAY
 

---

## Parameters

---

 -20.000 to 00.000 to 20.000 usec
 

---

## 21. SYSTEM MENU

The SYSTEM menu is used to configure the LT 4610.

To display the SYSTEM menu, press MENU several times until the following menu appears. These settings are not stored to presets.

```

0. SYSTEM
▼ LCD BACKLIGHT  ↵
  
```

### 21.1 Setting the Backlight

To set the backlight, follow the procedure below.

```

1. LCD BACKLIGHT
■ ON  □ AUTO OFF  □ OFF
  
```

#### Procedure

SYSTEM → LCD BACKLIGHT

#### Parameters

**ON:** The backlight is on at all times.

**AUTO OFF:** The backlight turns off if none of the keys are used for 30 seconds. It turns back on when a key is used.

**OFF:** The backlight is off at all times.

### 21.2 Turning Key Lock On and Off

To turn key lock on and off, follow the procedure below.

```

1. KEY LOCK
□ ON  ■ OFF
  
```

#### Procedure

SYSTEM → KEY LOCK

#### Parameters

**ON:** The LT 4610 locks its keys after 30 seconds of inactivity (no key operations). When key lock is enabled, you can temporarily disable key lock by holding down FUNCTION for 3 seconds.

**OFF:** Key lock is disabled.

21.3 Configuring Presets

Under SYSTEM→PRESET, you can set presets.

A preset is a collection of LT 4610 settings that are registered. It can be recalled automatically at startup.



The following settings are stored in a preset. (Y: Saved, N: Not saved)

GENLOCK Menu		Y
	LOG LIST (00 to 99)	N
BLACK menu		Y
SDI menu		Y
	ID CHARACTER (INT_1 to INT_4)	N
	LOGO (INT_1 to INT_4)	N
AES/EBU menu		Y
WCLK menu		Y
ETC Menu		Y
GPS OPTION menu (SER01)		Y
GNSS OPTION menu (SER04)		Y
12G OPTION menu (SER02)		Y
	USER PATTERN (INT1 to INT8)	N (*1)
	ID CHARACTER (INT_1 to INT_4)	N
	LOGO (INT_1 to INT_4)	N
PTP OPTION menu (SER03)		Y
SYSTEM menu		N

\*1 If you move a user pattern to the display memory beforehand, you can recall the user pattern as a preset.

For the setting of display memory, see 19.3.4, "Displaying a User Pattern."

21.3.1 Loading Presets

To recall a preset that you saved according to the procedure in 21.3.2, "Saving Presets," follow the procedure below.

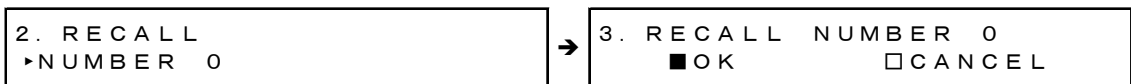

Procedure

SYSTEM → PRESET → RECALL

Parameters

NUMBER 0 to NUMBER 9

## 21. SYSTEM MENU

### 21.3.2 Saving Presets

You can save up to 10 presets by following the procedure below.

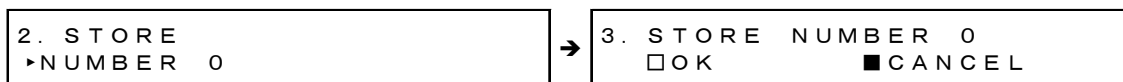

Procedure

---

SYSTEM → PRESET → STORE

---

Parameters

---

NUMBER 0 to NUMBER 9

---

### 21.3.3 Power-on Settings

To select the preset to use for starting the LT 4610, follow the procedure below. For details, see 7.1, "Turning the Power On."



Procedure

---

SYSTEM → PRESET → POWER ON RECALL

---

Parameters

---

OFF:                                   The LT 4610 starts with the same settings that were set when it was last turned OFF.

NUMBER 0 to NUMBER 9: The LT 4610 starts with the selected preset.

---



## 21. SYSTEM MENU

### 21.3.4 Copying Presets to the LT 4610

To copy presets from a USB memory device to the LT 4610, follow the procedure below. This feature is useful when you want to use multiple LT 4610s with the same settings. (Copy the presets to the USB memory device in advance by using the COPY INT→USB menu.)

If there is already a preset stored in the LT 4610, it will be overwritten. This setting appears when a USB memory device is connected.

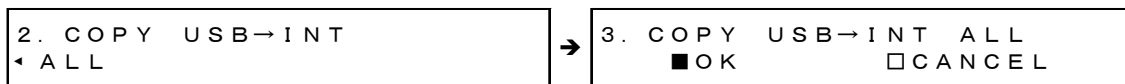

#### Procedure

SYSTEM → PRESET → COPY USB→INT

#### Parameters

ALL / NUMBER 0 to NUMBER 9

#### • USB Memory Device File Structure

Presets are copied from the PSET folder of the USB memory device.

```
└─ USB memory device
   └─ LT4610_USER
      └─ PSET
         ├── PRESET_00.PRE
         ├── ...
         └─ PRESET_09.PRE
```

## 21. SYSTEM MENU

### 21.3.5 Copying Presets to a USB Memory Device

To copy presets in pre format (dedicated format) from the LT 4610 to a USB memory device, follow the procedure below. This feature is useful when you want to use multiple LT 4610s with the same settings. (Save the presets in the LT 4610 in advance by using the STORE menu.)

If there is already a preset stored in the USB memory device, it will be overwritten. This setting appears when a USB memory device is connected.

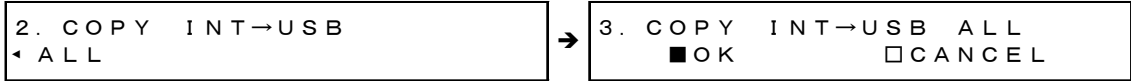

#### Procedure

SYSTEM → PRESET → COPY INT→USB

#### Parameters

ALL / NUMBER 0 to NUMBER 9

#### • USB Memory Device File Structure

Presets are copied from the PSET folder of the USB memory device. (See 21.3.4, "Copying Presets to the LT 4610.")

The date and time of the file will be those selected in 21.6.1, "Selecting the Date and Time."

### 21.3.6 Clearing Presets

To clear presets stored in the LT 4610, follow the procedure below.

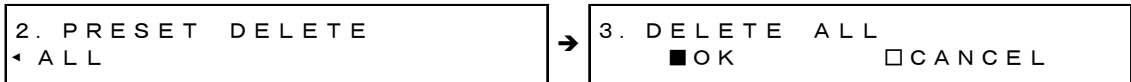

#### Procedure

SYSTEM → PRESET → DELETE

#### Parameters

ALL / NUMBER 0 to NUMBER 9

## 21.4 Configuring Ethernet Settings

Under SYSTEM→ETHERNET, you can set Ethernet parameters.

```

0. SYSTEM
└─ETHERNET
    
```

### 21.4.1 Setting the IP Address

To set the IP address, subnet mask, and default gateway, follow the procedure below.

```

2. IP ADDRESS      2. SUBNET MASK
192.168.000.001  255.255.255.000
└────────────────┘ └────────────────┘
└────────────────┘ └────────────────┘
2. DEFAULT GATEWAY 3. CONFIRM
000.000.000.000  [X]OK [ ]CANCEL
    
```

Procedure

SYSTEM → ETHERNET → IP ADDRESS

Parameters

000.000.000.000 to 255.255.255.255

(IP ADDRESS default value: 192.168.000.001, SUBNET MASK default value:  
255.255.255.000,

DEFAULT GATEWAY default value: 000.000.000.000)

### 21.4.2 Viewing the MAC Address

To view the MAC address of the LT 4110, follow the procedure below.

```

2. MAC ADDRESS
* * : * * : * * : * * : * * : * *
    
```

Procedure

SYSTEM → ETHERNET → MAC ADDRESS

### 21.4.3 Turning TRAP Transmission On and Off

To turn the SNMP TRAP transmission on and off, follow the procedure below.

```

2. SNMP TRAP
[ ]ON [X]OFF
    
```

Procedure

SYSTEM → ETHERNET → SNMP TRAP

Parameters

ON / OFF

## 21.4.4 Setting the Trap Transmission Destination

To set the IP address of the SNMP manager to send SNMP traps to, follow the procedure below.

```
2. SNMP MANAGER IP
   0 0 0 . 0 0 0 . 0 0 0 . 0 0 0
```

## Procedure

---

SYSTEM → ETHERNET → SNMP MANAGER IP

---

## Parameters

---

000.000.000.000 to 255.255.255.255

---

## 21.4.5 Copying MIB Files to a USB Memory Device

To copy an MIB file, which is used for SNMP, from the LT 4610 to a USB memory device, select OK by following the procedure below.

If there is already a MIB file stored in the USB memory device, it will be overwritten.

This setting appears when a USB memory device is connected.

```
2. COPY MIB INT→USB
    OK           CANCEL
```

## Procedure

---

SYSTEM → ETHERNET → COPY MIB INT→USB

---

- USB Memory Device File Structure

The MIB file is saved in the MIB folder of the USB memory device.

```

├─ USB memory device
├─ LT4610
│  └─ MIB
│     └─ lt4610.my
```

## 21.4.6 Setting READ COMMUNITY

To change the SNMP READ COMMUNITY name, follow the procedure below.

```
3. READ COMMUNITY
  LDRUser
```

---

 Procedure

SYSTEM → ETHERNET → SNMP COMMUNITY → READ COMMUNITY

---

## Parameters

---

▲0123456789  
 ABCDEFGHIJKLMNOPQRSTUVWXYZ  
 abcdefghijklmnopqrstuvwxyz  
 (Default value: LDRUser▲)

---

\* Changes to COMMUNITY is applied when SNMP is restarted or the next time the power is turned on.

## 21.4.7 Setting WRITE COMMUNITY

To change the SNMP WRITE COMMUNITY name, follow the procedure below.

```
3. WRITE COMMUNITY
  LDRAdm
```

---

 Procedure

SYSTEM → ETHERNET → SNMP COMMUNITY → WRITE COMMUNITY

---

## Parameters

---

▲0123456789  
 ABCDEFGHIJKLMNOPQRSTUVWXYZ  
 abcdefghijklmnopqrstuvwxyz  
 (Default value: LDRAdm▲)

---

\* Changes to COMMUNITY is applied when SNMP is restarted or the next time the power is turned on.

## 21.4.8 Setting TRAP COMMUNITY

To change the SNMP TRAP COMMUNITY name, follow the procedure below.

```

3. TRAP COMMUNITY
└─LDRUser▲

```

---

 Procedure

SYSTEM → ETHERNET → SNMP COMMUNITY → TRAP COMMUNITY

---

## Parameters

---

▲0123456789  
 ABCDEFGHIJKLMNOPQRSTUVWXYZ  
 abcdefghijklmnopqrstuvwxyz  
 (Default value: LDRUser▲)

---

\* Changes to COMMUNITY is applied when SNMP is restarted or the next time the power is turned on.

## 21.4.9 Restarting SNMP

To restart SNMP, follow the procedure below.

```

3. SNMP RESTART
   □ ON           ■ OFF

```

---

 Procedure

SYSTEM → ETHERNET → SNMP COMMUNITY → SNMP RESTART

---

## 21.5 Setting the PTP Ethernet Parameters (SER03)

Under SYSTEM→PTP ETHERNET, you can set PTP Ethernet parameters.

```

0. SYSTEM
└ PTP ETHERNET      ↵
  
```

## 21.5.1 Setting the PTP IP Address

To set the IP address, follow the procedure below.

```

2. PTP IP ADDRESS
  192.168.000.001
  
```

Procedure

---

SYSTEM → PTP ETHERNET → IP ADDRESS

---

Parameters

---

000.000.000.000 to 192.168.000.001 to 255.255.255.255

---

## 21.5.2 Setting the PTP Subnet Mask

To set the subnet mask, follow the procedure below.

```

2. PTP SUBNET MASK
  255.255.255.000
  
```

Procedure

---

SYSTEM → PTP ETHERNET → PTP SUBNET MASK

---

Parameters

---

000.000.000.000 to 255.255.255.000 to 255.255.255.255

---

## 21.5.3 Setting the PTP Gateway

To set the IP address, follow the procedure below.

```

2. PTP GATEWAY
  000.000.000.000
  
```

Procedure

---

SYSTEM → PTP ETHERNET → PTP GATEWAY

---

Parameters

---

000.000.000.000 to 255.255.255.255

---

## 21. SYSTEM MENU

### 21.5.4 Viewing the PTP MAC Address

To view the PTP MAC address of the LT 4610, follow the procedure below.

```
2. MAC ADDRESS
  00:09:0D:XX:XX:XX
```

Procedure

---

SYSTEM → PTP ETHERNET → MAC ADDRESS

---

### 21.5.5 Viewing the PTP CLOCK IDENTITY

To view the PTP CLOCK IDENTITY of the LT 4610, follow the procedure below.

```
2. CLOCK IDENTITY
  0x00090DFFEXXXXXX
```

Procedure

---

SYSTEM → PTP ETHERNET → CLOCK IDENTITY

---

### 21.5.6 Setting SFP/SFP+

To select between SFP and SFP+, follow the procedure below.

```
2. PTP SFP/SFP+
  ▶ * SFP
```

Procedure

---

SYSTEM → PTP ETHERNET → SFP/SFP+

---

Parameters

---

SFP / SFP+

---

- \* Make the selection with the module connected with a cable.  
Connection may not be established if the module is inserted or the cable is connected after making the selection.



21.5.7 Setting PORT RELATION

To configure the RJ45 and SFP/SFP+ connections, follow the procedure below.

```

2. PTP PORT RELATION
  ▶ * I S O L A T E D
    
```

Procedure

SYSTEM → PTP ETHERNET → PORT RELATION

Parameters

**FULLY CROSS-LINK:** There is packet communication between RJ45 and SFP.

**ISOLATED:** There is no packet communication between RJ45 and SFP.

**MIRROR RJ45 TO SFP:** Packets passing through RJ45 can be monitored on the SFP side.

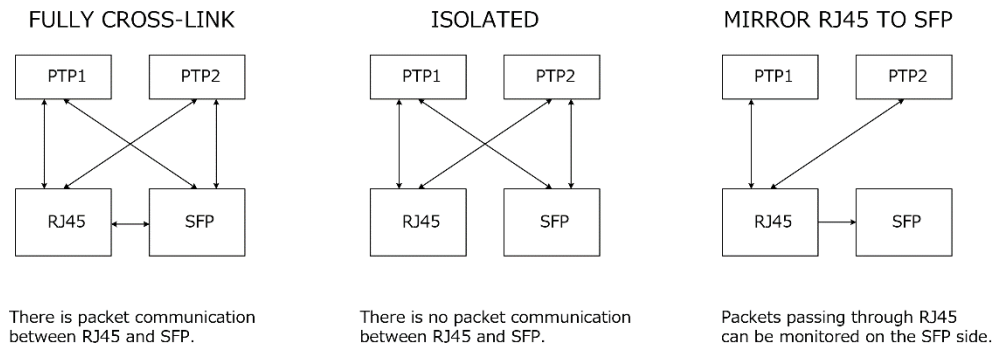

Figure 21-1 PORT RELATION

## 21.6 Date and time settings

Under SYSTEM→DATE&TIME, you can set the internal time.



### 21.6.1 Selecting the Date and Time

To select the internal time type, follow the procedure below.

The internal time can be saved to a USB memory device. The time is used in the genlock log.



#### Procedure

SYSTEM → DATA&TIME → SOURCE

#### Parameters

<u>INTERNAL:</u>	The date and time adjusted using the ADJUST menu are used.
GPS:	The date and time in the GPS signal received through GPS IN on the rear panel are used. You can select this option when SER01 is installed.
GNSS:	The date and time in the GNSS signal received through GNSS IN on the rear panel are used. You can select this option when SER04 is installed.
PTP:	The date and time in the PTP signal received through PTP on the rear panel are used. You can select this option when SER03 is installed.

\* If the SER03 is installed, the internal time is fixed depending on the genlock mode setting. For details on the genlock mode settings, see 10.1, "Selecting the Genlock Mode."

The following table shows the relationship between the genlock mode setting and the internal time type for when the SER03 is installed.

Genlock mode	DATA&TIME SOURCE
INTERNAL GL FMT-AUTO GL FMT-MANUAL 10MHzCW (SER01/SER04)	INTERNAL
GPS (SER01)	GPS
GNSS (SER04)	GNSS
PTP (SER03)	PTP

## 21.6.2 Adjusting the Date and Time

When DATE&TIME SOURCE is set to INTERNAL, to adjust the date and time, follow the procedure below.

2. DATE&TIME ADJUST 2018/04/01 12:34:5 <u>6</u>
--

Procedure

---

SYSTEM → DATA&TIME → ADJUST

---

Parameters

---

2000/01/01 00:00:00 to 2099/12/31 23:59:59

---

## 21.7 Setting the Time Code (SER01/SER03/SER04)

Under SYSTEM→TIMECODE, you can set the time code.

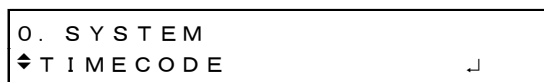

## 21.7.1 Selecting the Time Code

To select the time code type, follow the procedure below.

The time code selected here can be inserted into the black signal (VITC), SDI signal (ATC-LTC), and AES/EBU signal.

You can also output from LTC IN / OUT on the rear panel.



## Procedure

SYSTEM → TIMECODE → TIMECODE SOURCE

## Parameters

GPS:	The date and time in the GPS signal received through GPS IN on the rear panel are used. (SER01)
GNSS:	The date and time in the GNSS signal received through GNSS IN on the rear panel are used. (SER04)
<u>INTERNAL</u> :	The date and time selected in 21.6.1, "Selecting the Date and Time," are used.
LTC0:	The date and time in the LTC signal received through LTC IN/OUT on the rear panel are used. (SER01/SER04)
VITC:	The time in the VITC signal received through GENLOCK IN on the rear panel are used. The date in the INTERNAL are used.
SMPTE ST309:	The date and time in the SMPTE ST309 received through GENLOCK IN on the rear panel are used
PTP:	The date and time received through PTP slave are used. (SER03)

\* If the SER03 is installed, the selectable settings are limited depending on the genlock mode setting. For details on the genlock mode settings, see 10.1, "Selecting the Genlock Mode."

The following table shows the relationship between the genlock mode setting and the internal time type for when the SER03 is installed.

Genlock mode	TIMECODE SOURCE
INTERNAL 10MHzCW (SER01/SER04)	INTERNAL, LTC0
GL FMT-AUTO GL FMT-MANUAL	INTERNAL, LTC0 (*1), VITC (*2), SMPTE ST309 (*2), PTP (SER03)
GPS (SER01)	GPS
GNSS (SER04)	GNSS
PTP (SER03)	PTP

\*1 PTP does not support LTC0.

\*2 Only valid when the external reference signal is PAL. For NTSC, the INTERNAL time code is output.

## 21. SYSTEM MENU

### 21.7.2 Setting Dropped Frames

To select the dropped frame setting, follow the procedure below.

For time codes inserted into SDI signals, this setting is valid when the SDI signal frame (field) frequency is 59.94 or 29.97. For LTC output, this setting is valid when the Black 1 format is NTSC, 59.94, or 29.97.

2. D R O P F R A M E <input checked="" type="checkbox"/> O N <input type="checkbox"/> O F F
--

#### Procedure

---

SYSTEM → TIMECODE → DROP FRAME

---

#### Parameters

ON:                      Dropped frame time code is used.

OFF:                     Non-dropped frame time code is used.

---

### 21.7.3 Turning Jam Sync On and Off

To turn the jam sync function on and off, follow the procedure below.

When set to ON, the time code is reset once a day at the time set on the ADJUST menu.

3. J A M S Y N C <input checked="" type="checkbox"/> O N <input type="checkbox"/> O F F
--

#### Procedure

---

SYSTEM → TIMECODE → JAM SYNC → ON/OFF

---

#### Parameters

ON / OFF

---

## 21. SYSTEM MENU

### 21.7.4 Setting the Jam Sync Time

To set when to reset the time code using the jam sync function, follow the procedure below.

This setting is valid when JAM SYNC is set to ON.

```
3. J A M   S Y N C   A D J U S T
   0 0 : 0 0 : 0 0 [ H H : M M : S S ]
```

Procedure

SYSTEM → TIMECODE → JAM SYNC → ADJUST

Parameters

00:00:00 to 23:59:59

### 21.7.5 Turning the Daylight Savings Time On and Off

When TIMECODE SOURCE is set to GPS, to set whether to apply Daylight Savings Time, follow the procedure below.

```
3. D A Y L I G H T   S A V I N G
    O N            O F F
```

Procedure

SYSTEM → TIMECODE → DAYLIGHT SAVING → ON/OFF

Parameters

ON / OFF

### 21.7.6 Setting the Daylight Savings Time Start Date

When TIMECODE SOURCE is set to GPS, to set the Daylight Saving Time start date, follow the procedure below. (You cannot set seconds.)

```
3. C H A N G E   D A Y
   0 1 / 0 1   0 0 : 0 0 : 0 0
```

Procedure

SYSTEM → TIMECODE → DAYLIGHT SAVING → CHANGE DAY

Parameters

01/01 00:00:00 to 12/31 23:59:00

21.7.7 Setting the Daylight Saving Time Offset

When TIMECODE SOURCE is set to GPS, to set the Daylight Saving Time offset, follow the procedure below.

```
3. TIMECODE OFFSET
+00:00:00 [HH:MM:SS]
```

Procedure

SYSTEM → TIMECODE → DAYLIGHT SAVING → TIMECODE OFFSET

Parameters

-23:59:59 to +00:00:00 to +23:59:59

21.7.8 Setting the Daylight Savings Time End Date

When TIMECODE SOURCE is set to GPS, to set the Daylight Saving Time end date, follow the procedure below. (You cannot set seconds.)

```
3. RETURN DAY
01/01 00:00:00
```

Procedure

SYSTEM → TIMECODE → DAYLIGHT SAVING → RETURN DAY

Parameters

01/01 00:00:00 to 12/31 23:59:00

21.7.9 Setting the Leap Second

A leap second is automatically inserted at the last time of June 30th or December 31st of UTC, but when TIMECODE SOURCE is GPS / GNSS, the time to insert a leap second is set to SCHEDULED TIME, follow the procedure below. You can insert it with a delay of the set time and minutes.

(You cannot set seconds.)

However, this feature does not apply to PTP.

```
2. SCHEDULED TIME
00:00:00 [HH:MM:SS]
```

Procedure

SYSTEM → TIMECODE → LEAP SECOND

Parameters

00:00:00 to 11:59:00 PM

## 21.8 Setting GPS/PTP or GNSS / PTP (applies to both SER01 and SER03, or SER04/SER03)

Under SYSTEM→GPS/PTP, you can set the GPS and PTP.

When SER01 is installed

```
0. SYSTEM
◆GPS OPTION      ↵
```

When SER04 is installed

```
0. SYSTEM
◆GNSS OPTION     ↵
```

When SER03 is installed

```
0. SYSTEM
◆PTP OPTION      ↵
```

When SER01 and SER03 are installed

```
0. SYSTEM
◆GPS/PTP OPTION  ↵
```

When SER04 and SER03 are installed

```
0. SYSTEM
◆GNSS/PTP OPTION ↵
```

### 21.8.1 Selecting the Time Zone

To select the time zone, follow the procedure below. Select it according to your region.

```
2. TIMEZONE OFFSET
◆*UTC+09:00
```

Procedure

---

SYSTEM → GPS/PTP OPTION or GNSS/PTP OPTION → TIMEZONE OFFSET

---

Parameters

---

UTC-12:00 to UTC+09:00 to UTC+12:00

---



## 21. SYSTEM MENU

### 21.8.2 Setting the Power Supply

To select the supply voltage to apply to the GPS antenna, follow the procedure below. Select OFF to not supply power.

```
2. ANTENNA POWER
  ■ OFF   □ 3. 3V   □ 5V
```

#### Procedure

SYSTEM → GPS/PTP OPTION or GNSS/PTP OPTION → ANTENNA POWER

#### Parameters

OFF / 3.3V / 5V

### 21.8.3 Selecting the Operating Environment (SER01)

To select the operating environment of the GPS or GNSS antenna, follow the procedure below.

```
2. PLATFORM MODE
  ▶ *STATIONARY
```

#### Procedure

SYSTEM → GPS/PTP OPTION → PLATFORM MODE

#### Parameters

STATIONARY: Stationary environment such as in a room

AUTOMOTIVE: Mobile environment such as in an outside broadcast van

### 21.8.4 Selecting the Epoch

To select the starting date and time, follow the procedure below.

```
2. EPOCH
  ■ SMPTE   □ TAI
```

#### Procedure

SYSTEM → GPS/PTP OPTION or GNSS/PTP OPTION → EPOCH

#### Parameters

SMPTE: Conforms to PTP 1970 (SMPTE Epoch)

TAI: Conforms to TAI 1958

## 21.9 Setting the Alarm (SER01/SER04)

Under SYSTEM→ALARM, you can set the alarms output from LTC IN/OUT on the rear panel. INDICATOR 1 and INDICATOR 2 correspond to alarm output 1 and alarm output 2, respectively.

[See also] 7.6.9, "LTC Signal I/O (SER01/SER04)"

```

0. SYSTEM
◆ ALARM
  
```

## 21.9.1 Selecting the Polarity

To select the polarity of the alarm output from the selected connector, follow the procedure below.

```

3. ALARM POLARITY
■ POSITIVE □ NEGATIVE
  
```

Procedure

---

SYSTEM → ALARM → INDICATOR 1 / INDICATOR 2 → ALARM POLARITY

---

Parameters

---

POSITIVE / NEGATIVE

---

21.9.2 Turning the Alarm Output On and Off

To turn on or off the alarm output from the selected connector, follow the procedure below. If any of the alarms that are enabled occurs, an alarm is output.



Procedure

- 
- SYSTEM → ALARM → INDICATOR 1 / INDICATOR 2 → ALARM OPTION
- POWER1
  - POWER2
  - FAN
  - GENLOCK NO SIGNAL
  - GENLOCK ST IN SYNC
  - GPS ANNTENA
  - GPS PLL
  - GPS SIGNAL
  - GNSS ANNTENA
  - GNSS PLL
  - GNSS SIGNAL
  - CW SIGNAL
  - LTC0 SIGNAL
  - VITC SIGNAL
  - PTP1 PORT STATUS
  - PTP2 PORT STATUS
  - PTP1 LOCK
  - PTP2 LOCK
  - ATTENTION
- 

Parameters

- 
- ENABLE:**            An alarm is output when an alarm occurs.  
**DISABLE:**           Alarms are not output.
- 

21.10 Turning the Web Browser On and Off

To turn the Web browser on and off, follow the procedure below.



Procedure

- 
- SYSTEM → WEB BROWSER
- 

Parameters

- 
- ON:**                    The Web browser is turned on.  
**OFF:**                  The Web browser is turned off.
- 

- \* The displayed screen may be cached depending on the PC web browser settings.
- \* The web browser's refresh interval is 3 seconds.

## 21.11 Initialization

Under SYSTEM→INITIALIZE, you can initialize the settings.



There are two types of initialization: CLEAR SETTING and DEFAULT SETTING. They differ in the settings that are initialized as follows. (Yes: initialized, No: not initialized)

Note that the black signal format and SDI signal frame frequency are fixed to the values selected with FORMAT SETTING.

	CLEAR SETTING	DEFAULT SETTING
GENLOCK Menu	Yes	Yes
LOG LIST (00 to 99)	No	No
BLACK menu (including SER21)	Yes	Yes
SDI menu (SER22)	Yes	Yes
ID CHARACTER (INT_1 to INT_4)	No	Yes
LOGO (INT_1 to INT_4)	No	Yes
AES/EBU menu (SER23)	Yes	Yes
WCLK menu	Yes	Yes
ETC Menu	Yes	Yes
GPS OPTION menu (SER01)	Yes	Yes
GNSS OPTION menu (SER04)	Yes	Yes
12G OPTION menu (SER02)	Yes	Yes
USER PATTERN (INT1 to INT8)	No	No
ID CHARACTER (INT_1 to INT_4)	No	Yes
LOGO (INT_1 to INT_4)	No	Yes
PTP OPTION menu (SER03)	Yes	Yes
SYSTEM menu	No	Yes
DATE&TIME ADJUST	No	No

## 21.11.1 Initializing Settings

To initialize the settings (except for some settings such as those on the SYSTEM menu), select OK by following the procedure below.



Procedure

SYSTEM → INITIALIZE → CLEAR SETTING

## 21.11.2 Factory Default Initialization

To initialize the settings (except for some settings), select OK by following the procedure below.

2. D E F A U L T   S E T T I N G
<input checked="" type="checkbox"/> O K <input type="checkbox"/> C A N C E L

Procedure

---

SYSTEM → INITIALIZE → DEFAULT SETTING

---

## 21.11.3 Selecting the Format

To select the format that is applied when CLEAR SETTING or DEFAULT SETTING is used to initialize the instrument, follow the procedure below.

2. F O R M A T   S E T T I N G
<input checked="" type="checkbox"/> N T S C <input type="checkbox"/> P A L

Procedure

---

SYSTEM → INITIALIZE → FORMAT SETTING

---

Parameters



---

<u>NTSC:</u>	The black signal format is set to NTSC BB, and the SDI signal frame frequency is set to 59.94I.
<u>PAL:</u>	The black signal format is set to PAL BB, and the SDI signal frame frequency is set to 50I.

---

## 21.12 Viewing the Serial Numbers

To view the serial numbers of the main unit and SER01 to SER04, follow the procedure below.

To switch menus, use the  and  keys.

You can also view the serial number of the main unit on the rear panel.

The serial number is displayed when it is installed and "0000000" when it is not.

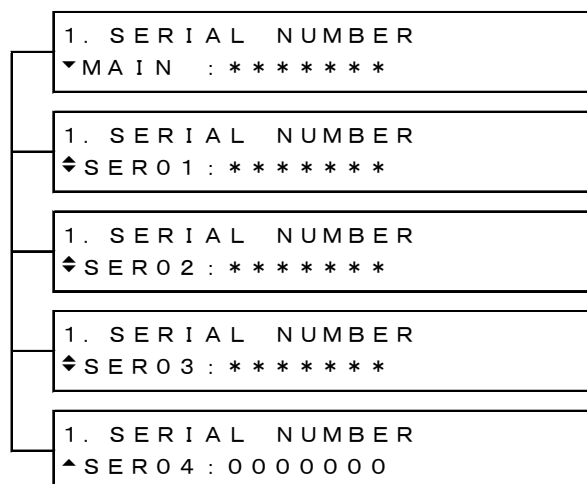

Procedure

---

SYSTEM → SERIAL NUMBER

---

## 21.13 Viewing and Installing Software Options

Under SYSTEM→LICENSE INFO., you can view and install software options.

```

0. SYSTEM
  ◆ LICENSE INFO.      ↵
  
```

### 21.13.1 Viewing Software Options

To view the software options that are installed, follow the procedure below.

Only the software options that are installed are displayed.

For the LT 4610, SER21, SER22 and SER23 are not displayed.

```

1. LICENSE INFO.
  ▼ SER21 : SYNC 3OUT ADD
  
```

```

1. LICENSE INFO.
  ◆ SER22 : SDI OUTPUT
  
```

```

1. LICENSE INFO.
  ◆ SER23 : AUDIO OUTPUT
  
```

```

1. LICENSE INFO.
  ◆ SER24 : 12G SDI 8K
  
```

Procedure

---

SYSTEM → LICENSE INFO.

---

### 21.13.2 Installing Software Options

To install software options, follow the procedure below.

Enter the issued license key.

When the installation is complete, "Accept" is displayed.

If "failed." is displayed, try entering the license key again.

```

2. LICENSE KEY INPUT
  0000000000
  
```

Procedure

---

SYSTEM → LICENSE INFO. → LICENSE KEY INPUT

---

## 21.14 Viewing the Version Information

To view the firmware version and FPGA version, follow the procedure below.

To switch menus, use the **▲** and **▼** keys.

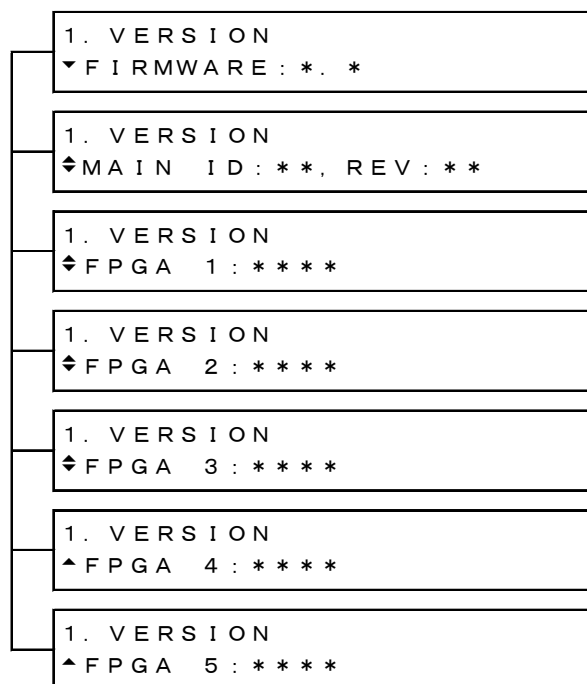

Procedure

---

SYSTEM → VERSION DISPLAY

---



## 22. LOGO APP

Logo App is a software for converting bitmap data (\*.bmp) into 4-level monochrome data (\*.lg) that can be used on the LT 4610. It is used to overlay logos created on the PC on SDI signals. If necessary, install the application from the accompanying CD-ROM.

Note that the model name indicated on the Logo App is LT 4600, but the application can be used with the LT 4610 and LT 4611 without any problems.

[See also] 12.9, "Setting Logos," and 18.9, "Setting Logos."

### 22.1 Installation

Follow the procedure below to install Logo App in your PC.  
The required PC operating environment is as follows.

- Microsoft Windows 7 / Vista
- Microsoft .Net Framework 3.5 or later must be installed.

1. Load the CD-ROM supplied with the LT 4610, and run LT4600\_LOGO\_Application\_Installer.msi.

⊗ CD-ROM

└─ [ ] Instruction\_Manual\_for\_LT4610\_LT4611

└─ [ ] LOGO\_Application\_v1.0

└─ [ ] LT4600\_LOGO\_Application\_Installer.msi

2. When the following window appears, click Next.

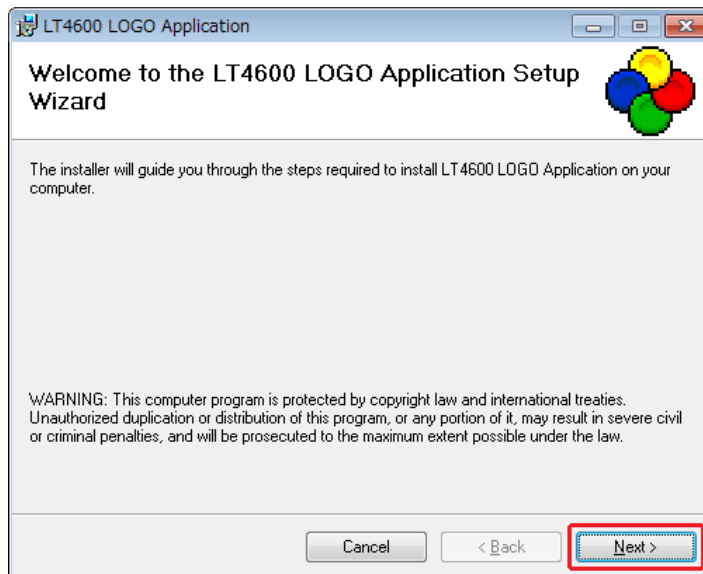

## 22. LOGO APP

3. When the following window appears, select the installation folder, and click Next.

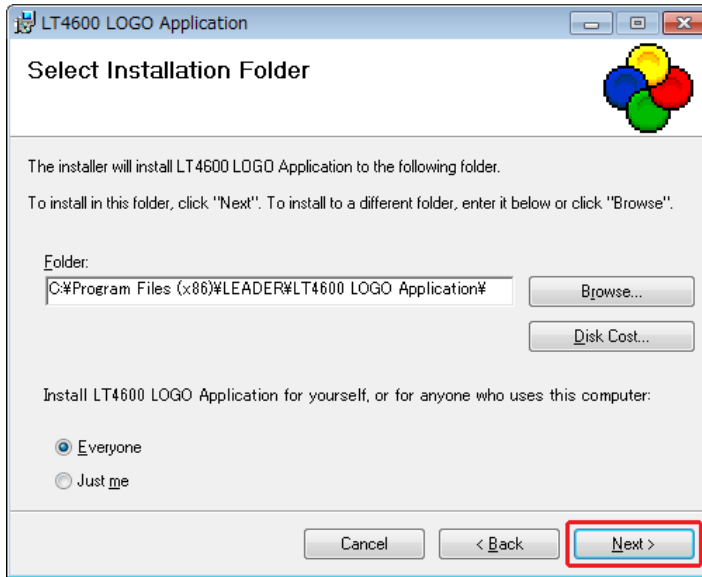

4. When the following window appears, click Next.

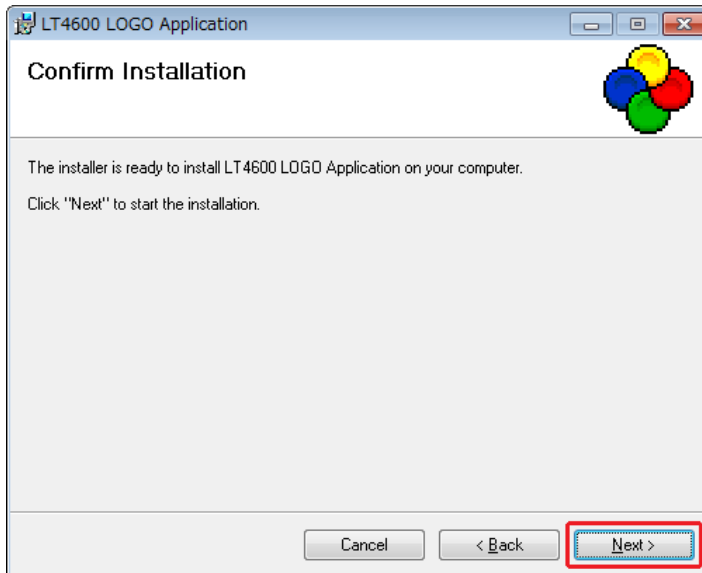

5. When the following window appears, the installation is complete. Click Close.

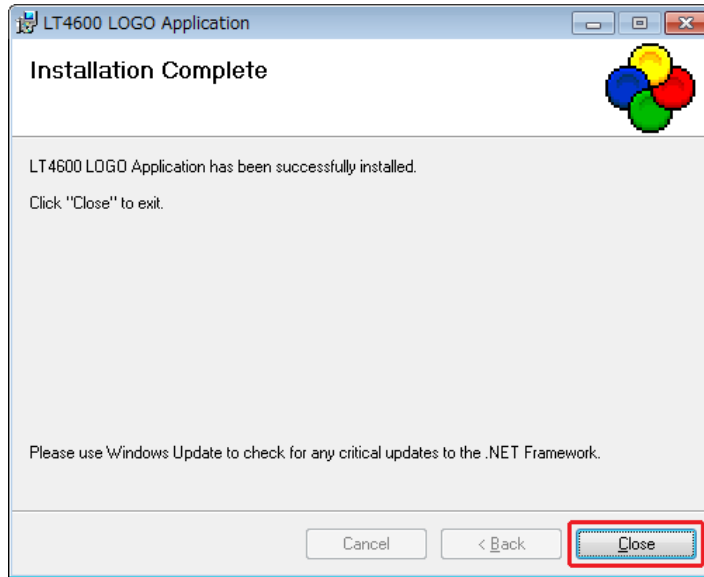

## 22.2 Uninstallation

To uninstall the software, select “LT4600 LOGO Application” in Programs and Features of Control Panel, and click Uninstall.

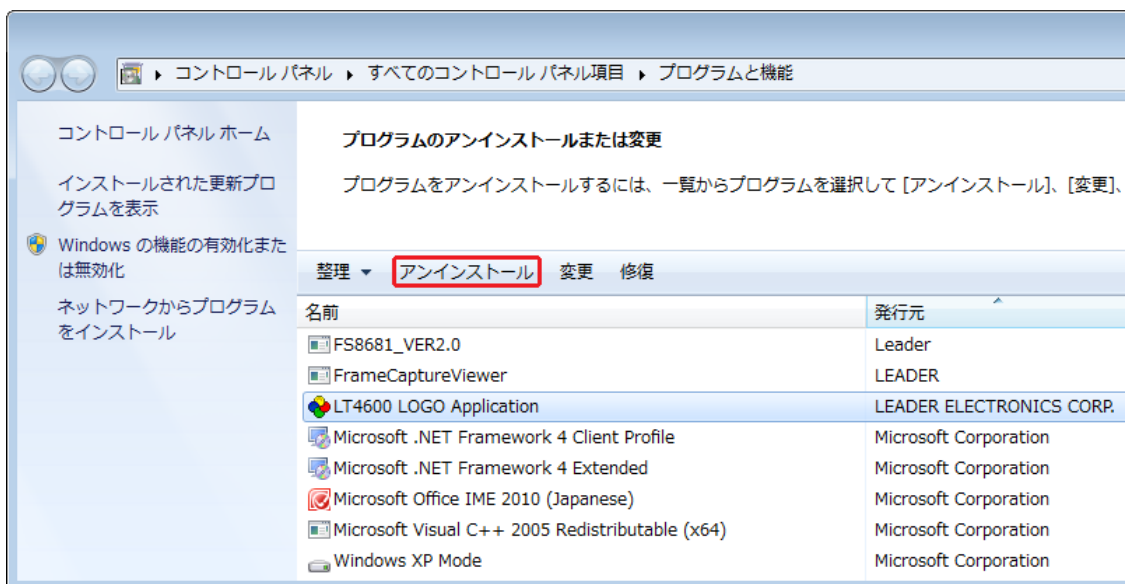

### 22.3 How to Use

To convert bitmap data (\*.bmp) into 4-level monochrome data (\*.lg), follow the procedure below.

1. Start "LT4600 LOGO Application" on the PC desktop.



2. Click Select File.

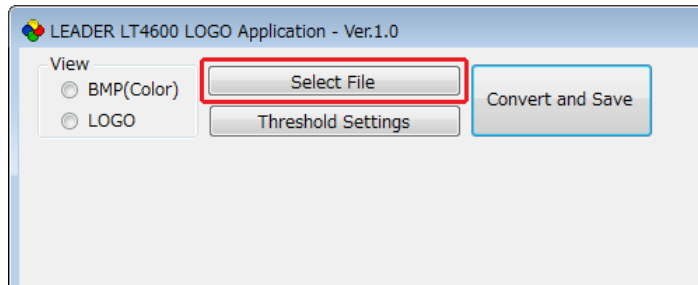

3. Select a bitmap file (\*.bmp).

Select a file that meets the following conditions. You cannot select a file (\*.lg) that has already been converted.

File name: Up to eight characters (excluding the extension) consisting of alphanumeric characters or underscore.

File format: 24 bits, 256 colors or 16 colors

File size: Up to 320 dots × 240 lines (width × height)

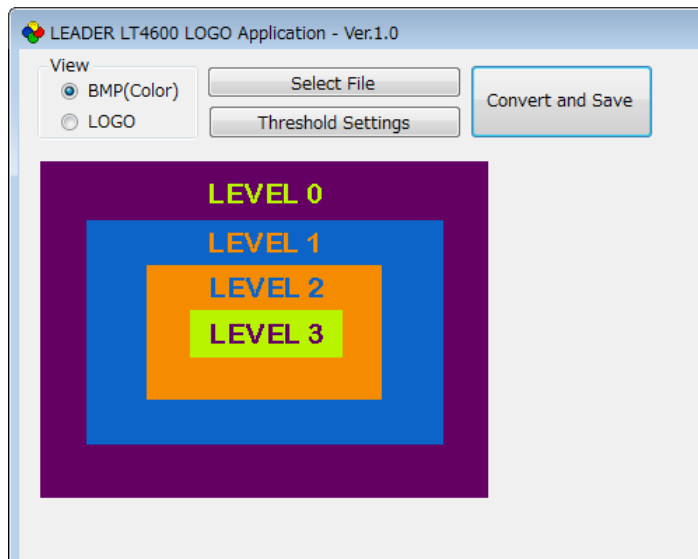

- Click LOGO to view the data after conversion.

If the data after the conversion appears okay, save the data. Proceed to step 7.

Here, only check that the colors have been separated into four grayscale levels. The intensity used to display the data on the actual LT 4610 can be adjusted from the menu, so it will be different from what appears here.

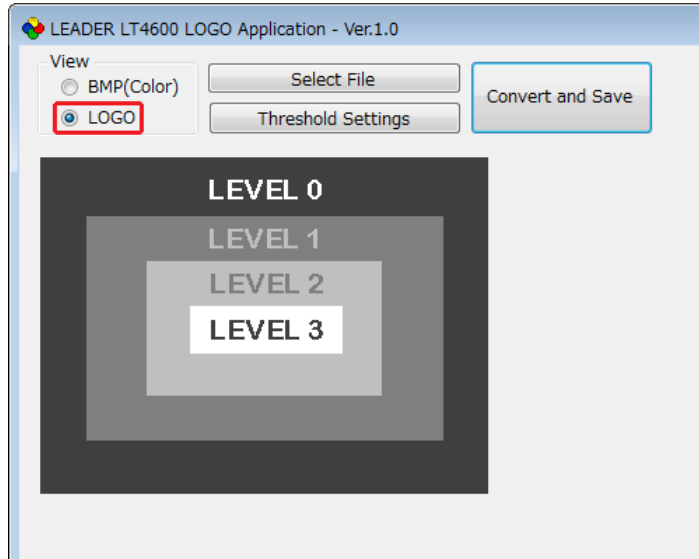

- Click Threshold Settings to set the conversion thresholds. Use the sliders to set the thresholds.

Main Window

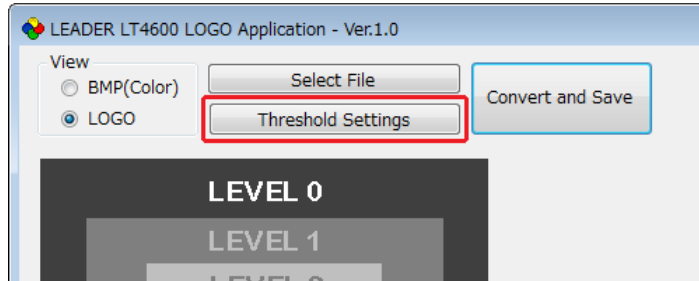

Level Threshold Settings Dialog Box

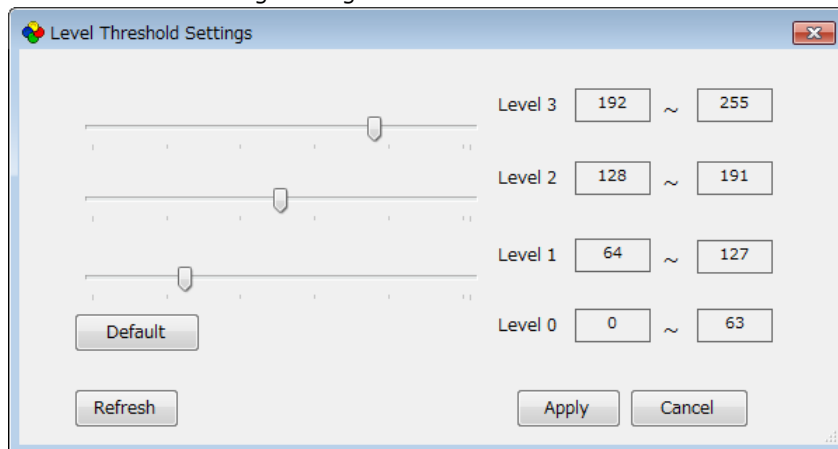

- Threshold

The threshold represents the intensity (Y). If we assume R, G, and B to take on values between 0 and 255, it can be derived from the following formula.

$$Y = 0.212 * R + 0.701 * G + 0.087 * B$$

For example, if the thresholds are set as shown in the above figure, Logo App converts data according to the following rules.

- Intensities 0 to 63 are converted to level 0 and displayed at intensity 63.
- Intensities 64 to 127 are converted to level 1 and displayed at intensity 127.
- Intensities 128 to 191 are converted to level 2 and displayed at intensity 191.
- Intensities 192 to 255 are converted to level 3 and displayed at intensity 255.

Conversion Example

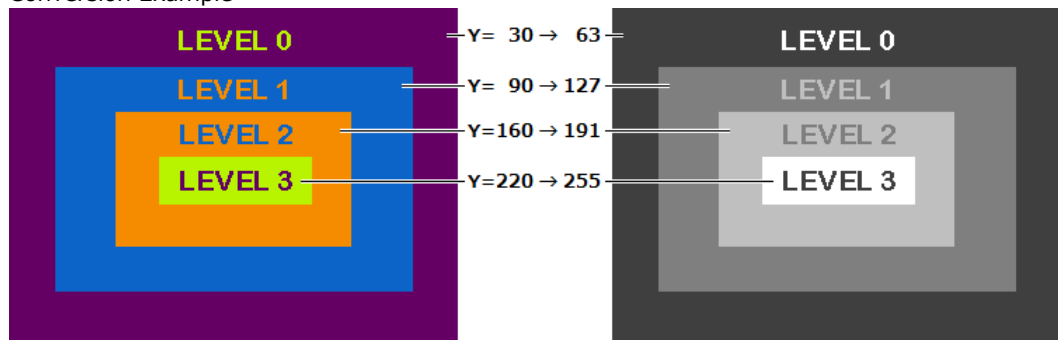

- Description of the Level Threshold Settings Dialog Box

Item	Description
Default	The thresholds are reset to the following values. Level 3: 192 to 255 Level 2: 128 to 191 Level 1: 64 to 127 Level 0: 0 to 63
Refresh	The result of the conversion by applying the specified thresholds is displayed in the main window. The values are not applied until you click Apply.
Apply	The values are applied, and the Level Threshold Settings dialog box closes.
Cancel	The values are canceled, and the Level Threshold Settings dialog box closes.

6. Click Apply to apply the settings.

## 22. LOGO APP

7. Click Convert and Save to convert and save the data.

The data saved in the same location as the original data with the same name but with a different extension.

Example: test.bmp → test.lg

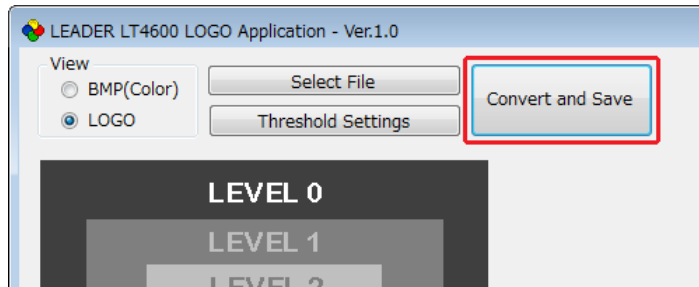

8. When the following confirmation message appears, click OK.

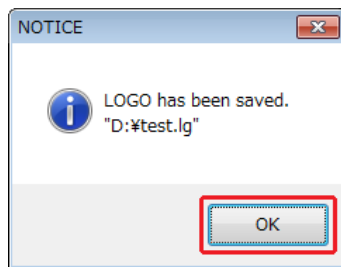

## 23. HTTP

You can use this feature to control the instrument from a web browser.

- \* The Ethernet features of the LT 4610 have only been confirmed to work in a local network environment. LEADER does not guarantee that they will work in any network environment.

### 23.1 Operating Environment

The following web browsers have been confirmed to work.

- Google Chrome Ver.46

### 23.2 How to Use

1. On the LT 4610, set the IP address.  
Set it under SYSTEM→ETHERNET→IP ADDRESS.  
[See also] 21.4.1, "Setting the IP Address."
2. On the LT 4610, set HTTP to ON.  
Set it under SYSTEM→WEB BROWSER.  
[See also] 21.10, "Turning the Web Browser On and Off."
3. Connect the LT 4610's ETHERNET/CONTROL connector to the external network device.
4. Start the web browser on your PC.
5. In the address box, enter "http://(the IP address that you set in step 1)."

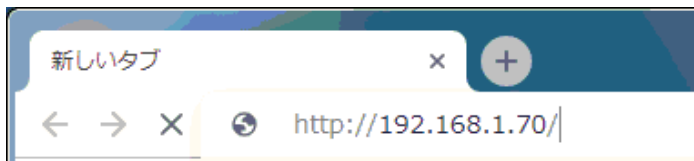

Figure 23-1 Entering the IP address

6. The SYNC GENERATOR LT 4610 window (\*1) will be displayed.

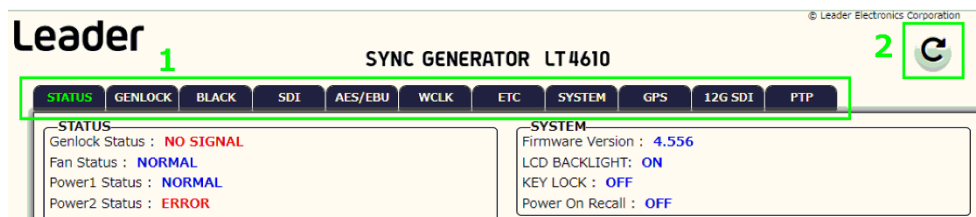

Figure 23-2 SYNC GENERATOR LT 4610 window (when SER01 is installed)

- \* Even if the LT 4611 is displayed as the LT 4610.
1. Tabs  
Left-click on the tab you want to select.  
The name of the selected tab will be green.  
The settings may not be reflected due to other settings and options.
  2. Reload  
Left-click to reload.



23.2.1 STATUS tab

The STATUS tab shows the LT 4610 status. This tab is only for viewing; you cannot change the settings.

For the display content, see 8, "STATUS MENU," and 9, "INFO MENU."

23.2.2 GENLOCK tab

The GENLOCK tab is used to specify settings related to genlock operation.

For the settings, see 10, "GENLOCK MENU."

23.2.3 BLACK tab

The BLACK tab is used to specify settings related to black output.

For the LT 4611, the black 4 to 6 settings are reflected when SER21 is installed.

For the settings, see 11, "BLACK MENU."

23.2.4 SDI tab

The SDI tab is used to specify settings related to SDI output.

For the LT 4611, the settings are reflected when SER22 is installed.

For the settings, see 12, "SDI MENU."

23.2.5 AES/EBU tab

The AES/EBU tab is used to specify settings related to AES/EBU output and silence output.

For the LT 4611, the settings are reflected when SER23 is installed.

For the settings, see 13, "AES/EBU MENU."

23.2.6 WCLK tab

The WCLK tab is used to specify settings related to WCLK output.

For the settings, see 14, "WCLK MENU."

23.2.7 ETC tab

The ETC tab is used to specify settings related to lip sync.

For the LT 4611, the settings are reflected when SER22 is installed.

For the settings, see 15, "ETC MENU."

23.2.8 SYSTEM tab

The SYSTEM tab is used to configure the LT 4610.

For the settings, see 21, "SYSTEM MENU."

23.2.9 GPS tab

The GPS tab is used to specify settings related to LTC output and CW I/O.

When SER01 is installed, the settings are reflected.

For the settings, see 16, "GPS OPTION MENU (SER01)."

## 23.2.10 GNSS tab

The GNSS tab is used to specify settings related to LTC output and CW I/O. When SER04 is installed, the settings are reflected. For the settings, see 17, "GNSS OPTION MENU (SER04)."

## 23.2.11 12G SDI tab

The 12G SDI tab is used to specify settings related to SDI output. When SER01 is installed, the settings are reflected. When SER24 is installed, the 8K setting also are reflected. For editing the user payload ID, see 23.2.12, "Editing User Payload ID." For other settings, see 17, "12G OPTION MENU (SER02)" and 19, "8K OPTION MENU (SER24)."

## 23.2.12 Editing User Payload ID

Edit the user payload ID in the USER PAYLOAD window on the 12G SDI tab. To display the USER PAYLOAD window, left-click  on the USER PAYLOAD bar.

You can edit the LINK1 to 4 payload IDs separately.

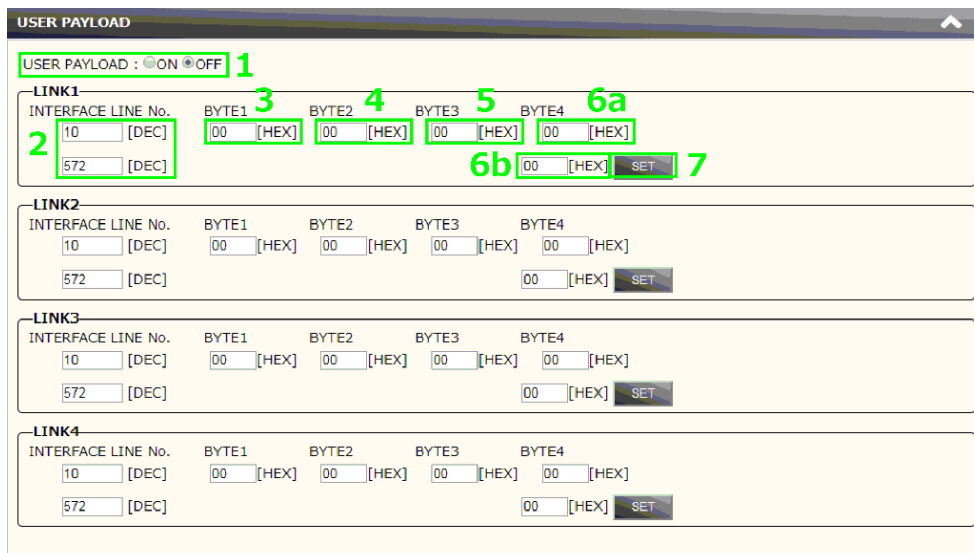

Figure 23-3 USER PAYLOAD window

## 1. USER PAYLOAD:

If you select ON, you can edit the user payload ID.

Parameters

ON / OFF

## 2. INTERFACE LINE NO.

Set the interface line number.

In case of interlace, set the line number of the second field in the field below.

## 3. BYTE1

Set the byte 1.

## 4. BYTE2

Set the byte 2.

## 5. BYTE3

Set the byte 3.

## 6. BYTE4

Set the byte 4 to 6a.

For 3G-B-DL or 3G-B-DS, set LINK A to 6a and LINK B to 6b.

## 7. SET

Left-click to set the LINK1 payload ID.

You can edit LINK2 to 4 in the same way.

## 23.2.13 Uploading User Pattern

Upload the user pattern in the DATA UPLOAD (under 100MByte) window on the 12G SDI tab.

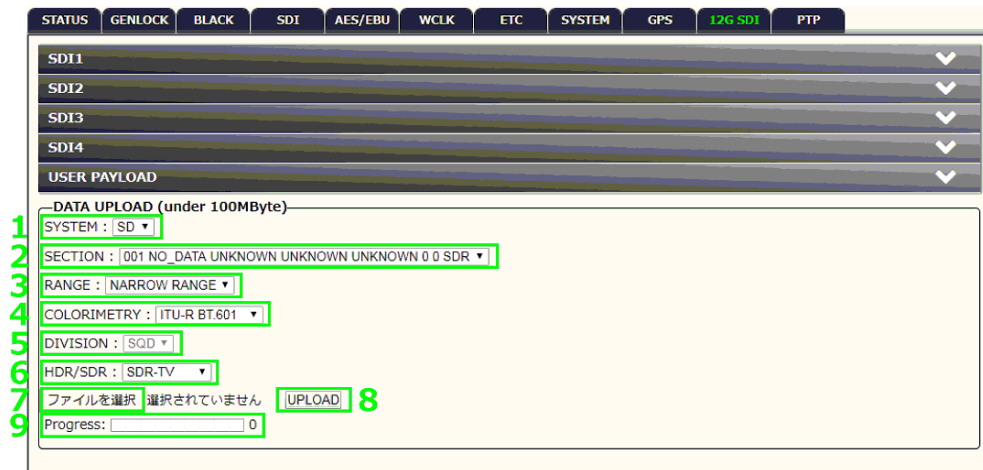

Figure 23-4 DATA UPLOAD (under 100MByte) window

## 1. SYSTEM

Select the SYSTEM.

Parameters

---

SD / HD / 4K / 8K

---

## 2. SECTION

Select the SECTION.

Parameters

---

001 NO\_DATA UNKNOWN UNKNOWN UNKNOWN 0 0 SDR /  
 002 NO\_DATA UNKNOWN UNKNOWN UNKNOWN 0 0 SDR /  
 003 NO\_DATA UNKNOWN UNKNOWN UNKNOWN 0 0 SDR /  
 004 NO\_DATA UNKNOWN UNKNOWN UNKNOWN 0 0 SDR /  
 005 NO\_DATA UNKNOWN UNKNOWN UNKNOWN 0 0 SDR /  
 006 NO\_DATA UNKNOWN UNKNOWN UNKNOWN 0 0 SDR /  
 007 NO\_DATA UNKNOWN UNKNOWN UNKNOWN 0 0 SDR /  
 008 NO\_DATA UNKNOWN UNKNOWN UNKNOWN 0 0 SDR /  
 009 NO\_DATA UNKNOWN UNKNOWN UNKNOWN 0 0 SDR /  
 010 NO\_DATA UNKNOWN UNKNOWN UNKNOWN 0 0 SDR /  
 011 NO\_DATA UNKNOWN UNKNOWN UNKNOWN 0 0 SDR /  
 012 NO\_DATA UNKNOWN UNKNOWN UNKNOWN 0 0 SDR /  
 013 NO\_DATA UNKNOWN UNKNOWN UNKNOWN 0 0 SDR /  
 014 NO\_DATA UNKNOWN UNKNOWN UNKNOWN 0 0 SDR /  
 015 NO\_DATA UNKNOWN UNKNOWN UNKNOWN 0 0 SDR /  
 016 NO\_DATA UNKNOWN UNKNOWN UNKNOWN 0 0 SDR /  
 017 NO\_DATA UNKNOWN UNKNOWN UNKNOWN 0 0 SDR /  
 018 NO\_DATA UNKNOWN UNKNOWN UNKNOWN 0 0 SDR /  
 019 NO\_DATA UNKNOWN UNKNOWN UNKNOWN 0 0 SDR /  
 020 NO\_DATA UNKNOWN UNKNOWN UNKNOWN 0 0 SDR /  
 021 NO\_DATA UNKNOWN UNKNOWN UNKNOWN 0 0 SDR /  
 022 NO\_DATA UNKNOWN UNKNOWN UNKNOWN 0 0 SDR /  
 023 NO\_DATA UNKNOWN UNKNOWN UNKNOWN 0 0 SDR /  
 024 NO\_DATA UNKNOWN UNKNOWN UNKNOWN 0 0 SDR /  
 025 NO\_DATA UNKNOWN UNKNOWN UNKNOWN 0 0 SDR /

---

## 3. RANGE

Select the RANGE.

Parameters

---

NARROW RANGE / FULL RANGE

---

## 4. COLORIMETRY

Select the COLORIMETRY.

Parameters

---

ITU-R BT.601 / ITU-R BT.709 / ITU-R BT.2020

---

## 5. DIVISION

Select the DIVISION.

You can select when SYSTEM is 4K.

## Parameters

---

<u>SQD</u> :	Square
2SI:	2 sample interleave

---

## 6. HDR/SDR

Select the HDR mode.

## Parameters

---

<u>SDR-TV</u> :	Set to SDR (OFF).
HLG:	Set to HLG (HDR).
PQ:	Set to PQ (HDR).
Unspecified	Select in modes other than the above, such as S-Log3 (Live HDR).

---

## 7. Select the file

Select the user pattern file.

## 8. UPLOAD

Upload the user pattern to the LT 4610.

## 9. Progress

Shows the upload progress.

## 23.2.14 PTP tab

The PTP tab is used to specify settings related to PTP.

When SER03 is installed, the settings are reflected.

For the settings, see 20, "PTP OPTION MENU (SER03)."

## 24. SNMP

By using SNMP (Simple Network Management Protocol), you can control an LT 4610 from SNMP managers. In addition, when the fan stops or other errors occur, traps can be sent from the LT 4610 to an SNMP manager.

- \* The Ethernet features of the LT 4610 have only been confirmed to work in a local network environment. LEADER does not guarantee that they will work in any network environment.
- \* DHCP client and DNS resolver features are not supported.

### 24.1 SNMP Version

SNMPv2c

### 24.2 SMI Definitions

```

IMPORTS
MODULE-IDENTITY, OBJECT-TYPE, NOTIFICATION-TYPE, enterprises
FROM SNMPv2-SMI
DisplayString
FROM SNMPv2-TC
OBJECT-GROUP, MODULE-COMPLIANCE
FROM SNMPv2-CONF;

```

### 24.3 How to Use

1. On the LT 4610, set the IP address.  
Set it under SYSTEM→ETHERNET→IP ADDRESS.
2. Connect the LT 4610's ETHERNET/CONTROL port to the network device.  
Connect to a network with an SNMP manager.
3. On the PC, start an SNMP manager.  
An SNMP manager is not supplied with the LT 4610. You will need to provide it yourself.  
For details on how to use the SNMP manager, see its instruction manual.

The community names are shown below. (default setting)

Read Community: LDRUser

Write Community: LDRAdm

4. On the SNMP manager, set the IP address of the trap transmission destination.  
You can also set it from the LT 4610 menu.

```

OID: 1.3.6.1.4.1.leader(20111).lt4610(36).trap(100).target(1).
trapManagerIp(1).0

```

5. On the SNMP manager, enable the TRAP transmission destinations.  
 OID: 1.3.6.1.4.1.leader(20111).lt4610(36).trap(100).target(1).trapAction(2).0  
 You can also set it from the LT 4610 menu.
6. Restart the LT 4610.
7. When the LT 4610 restarts, check that the standard trap "ColdStart" is received by the SNMP manager.

## 24.4 Enterprise MIB

- Retrieving the MIB File

Copy the file from the LT 4610 to a USB memory device.

Connect a USB memory device to the LT 4610, and from the menu, select SYSTEM > ETHERNET > COPY MIB INT > USB > OK. The file lt4610.my will be copied to the USB memory device.

For details on how to use the MIB file, see the instruction manual for the SNMP manager.

[See also]            21.4.5, "Copying MIB Files to a USB Memory Device"

- Enterprise Number

Leader's enterprise number is 20111.

iso(1).org(3).dod(6).internet(1).private(4).enterprises(1).leader(20111)

- MIB Structure

lt4610	OBJECT IDENTIFIER ::= { leader 36 }
notification	OBJECT IDENTIFIER ::= { lt4610 0 }
trapContent	OBJECT IDENTIFIER ::= { notification 1 }
error	OBJECT IDENTIFIER ::= { trapContent 1 }
normal	OBJECT IDENTIFIER ::= { trapContent 2 }
trapStr	OBJECT IDENTIFIER ::= { notification 2 }
standard	OBJECT IDENTIFIER ::= { lt4610 1 }
status	OBJECT IDENTIFIER ::= { standard 1 }
reference	OBJECT IDENTIFIER ::= { standard 2 }
genlockRef	OBJECT IDENTIFIER ::= { reference 1 }
blackRef	OBJECT IDENTIFIER ::= { reference 2 }
black1Ref	OBJECT IDENTIFIER ::= { blackRef 1 }
black2Ref	OBJECT IDENTIFIER ::= { blackRef 2 }
black3Ref	OBJECT IDENTIFIER ::= { blackRef 3 }
black4Ref	OBJECT IDENTIFIER ::= { blackRef 4 }
black5Ref	OBJECT IDENTIFIER ::= { blackRef 5 }
black6Ref	OBJECT IDENTIFIER ::= { blackRef 6 }
sdiRef	OBJECT IDENTIFIER ::= { reference 3 }
sdi1Ref	OBJECT IDENTIFIER ::= { sdiRef 1 }
sdi1Format	OBJECT IDENTIFIER ::= { sdi1Ref 1 }
sdi1Timing	OBJECT IDENTIFIER ::= { sdi1Ref 2 }
sdi1Pattern	OBJECT IDENTIFIER ::= { sdi1Ref 3 }
sdi1Component	OBJECT IDENTIFIER ::= { sdi1Ref 4 }
sdi1SafetyArea	OBJECT IDENTIFIER ::= { sdi1Ref 5 }

## 24. SNMP

sdi1Scroll	OBJECT IDENTIFIER ::= { sdi1Ref 6 }
sdi1PatternChange	OBJECT IDENTIFIER ::= { sdi1Ref 7 }
sdi1Id	OBJECT IDENTIFIER ::= { sdi1Ref 8 }
sdi1Logo	OBJECT IDENTIFIER ::= { sdi1Ref 9 }
sdi1Audio	OBJECT IDENTIFIER ::= { sdi1Ref 10 }
sdi2Ref	OBJECT IDENTIFIER ::= { sdiRef 2 }
sdi2Format	OBJECT IDENTIFIER ::= { sdi2Ref 1 }
sdi2Timing	OBJECT IDENTIFIER ::= { sdi2Ref 2 }
sdi2Pattern	OBJECT IDENTIFIER ::= { sdi2Ref 3 }
sdi2Component	OBJECT IDENTIFIER ::= { sdi2Ref 4 }
sdi2SafetyArea	OBJECT IDENTIFIER ::= { sdi2Ref 5 }
sdi2Scroll	OBJECT IDENTIFIER ::= { sdi2Ref 6 }
sdi2PatternChange	OBJECT IDENTIFIER ::= { sdi2Ref 7 }
sdi2Id	OBJECT IDENTIFIER ::= { sdi2Ref 8 }
sdi2Logo	OBJECT IDENTIFIER ::= { sdi2Ref 9 }
sdi2Audio	OBJECT IDENTIFIER ::= { sdi2Ref 10 }
lipsync	OBJECT IDENTIFIER ::= { reference 4 }
gps (*1)	OBJECT IDENTIFIER ::= { lt4610 2 }
gpsStat (*1)	OBJECT IDENTIFIER ::= { gps 1 } (*1)
gpsRef (*1)	OBJECT IDENTIFIER ::= { gps 2 } (*1)
system	OBJECT IDENTIFIER ::= { lt4610 3 }
presetRef	OBJECT IDENTIFIER ::= { system 1 }
sdi12g	OBJECT IDENTIFIER ::= { lt4610 4 }
sdi12g1Ref	OBJECT IDENTIFIER ::= { sdi12g 1 }
sdi12g1Format	OBJECT IDENTIFIER ::= { sdi12g1Ref 1 }
sdi12g1Timing	OBJECT IDENTIFIER ::= { sdi12g1Ref 2 }
sdi12g1Pattern	OBJECT IDENTIFIER ::= { sdi12g1Ref 3 }
sdi12g1Component	OBJECT IDENTIFIER ::= { sdi12g1Ref 4 }
sdi12g1SafetyArea	OBJECT IDENTIFIER ::= { sdi12g1Ref 5 }
sdi12g1Scroll	OBJECT IDENTIFIER ::= { sdi12g1Ref 6 }
sdi12g1PatternChange	OBJECT IDENTIFIER ::= { sdi12g1Ref 7 }
sdi12g1Id	OBJECT IDENTIFIER ::= { sdi12g1Ref 8 }
sdi12g1Logo	OBJECT IDENTIFIER ::= { sdi12g1Ref 9 }
sdi12g1MvBox	OBJECT IDENTIFIER ::= { sdi12g1Ref 10 }
sdi12g1Audio	OBJECT IDENTIFIER ::= { sdi12g1Ref 11 }
sdi12g1Lipsync	OBJECT IDENTIFIER ::= { sdi12g1Ref 12 }
sdi12g2Ref	OBJECT IDENTIFIER ::= { sdi12g 2 }
sdi12g2Timing	OBJECT IDENTIFIER ::= { sdi12g2Ref 2 }
sdi12g2Pattern	OBJECT IDENTIFIER ::= { sdi12g2Ref 3 }
sdi12g2Id	OBJECT IDENTIFIER ::= { sdi12g2Ref 8 }
sdi12g2Logo	OBJECT IDENTIFIER ::= { sdi12g2Ref 9 }
sdi12g2Audio	OBJECT IDENTIFIER ::= { sdi12g2Ref 11 }
sdi12g2Lipsync	OBJECT IDENTIFIER ::= { sdi12g2Ref 12 }
sdi12g3Ref	OBJECT IDENTIFIER ::= { sdi12g 3 }
sdi12g3Timing	OBJECT IDENTIFIER ::= { sdi12g3Ref 2 }



## 24. SNMP

sdi12g3Pattern	OBJECT IDENTIFIER ::= { sdi12g3Ref 3 }
sdi12g3Id	OBJECT IDENTIFIER ::= { sdi12g3Ref 8 }
sdi12g3Logo	OBJECT IDENTIFIER ::= { sdi12g3Ref 9 }
sdi12g3Audio	OBJECT IDENTIFIER ::= { sdi12g3Ref 11 }
sdi12g3Lipsync	OBJECT IDENTIFIER ::= { sdi12g3Ref 12 }
sdi12g4Ref	OBJECT IDENTIFIER ::= { sdi12g 4 }
sdi12g4Timing	OBJECT IDENTIFIER ::= { sdi12g4Ref 2 }
sdi12g4Pattern	OBJECT IDENTIFIER ::= { sdi12g4Ref 3 }
sdi12g4Id	OBJECT IDENTIFIER ::= { sdi12g4Ref 8 }
sdi12g4Logo	OBJECT IDENTIFIER ::= { sdi12g4Ref 9 }
sdi12g4Audio	OBJECT IDENTIFIER ::= { sdi12g4Ref 11 }
sdi12g4Lipsync	OBJECT IDENTIFIER ::= { sdi12g4Ref 12 }
ptp	OBJECT IDENTIFIER ::= { lt4610 5 }
ptp1Ref	OBJECT IDENTIFIER ::= { ptp 1 }
ptp1Mode	OBJECT IDENTIFIER ::= { ptp1Ref 1 }
ptp1ProfileType	OBJECT IDENTIFIER ::= { ptp1Ref 2 }
ptp1ProfileDefault	OBJECT IDENTIFIER ::= { ptp1Ref 3 }
ptp1Domain	OBJECT IDENTIFIER ::= { ptp1Ref 4 }
ptp1ComminucationMode	OBJECT IDENTIFIER ::= { ptp1Ref 5 }
ptp1AnnounceInterval	OBJECT IDENTIFIER ::= { ptp1Ref 6 }
ptp1SyncInterval	OBJECT IDENTIFIER ::= { ptp1Ref 7 }
ptp1AnnounceTimeout	OBJECT IDENTIFIER ::= { ptp1Ref 8 }
ptp1Priority1	OBJECT IDENTIFIER ::= { ptp1Ref 9 }
ptp1Priority2	OBJECT IDENTIFIER ::= { ptp1Ref 10 }
ptp1Step	OBJECT IDENTIFIER ::= { ptp1Ref 11 }
ptp1DefaultFrame	OBJECT IDENTIFIER ::= { ptp1Ref 12 }
ptp1DropFrameFlag	OBJECT IDENTIFIER ::= { ptp1Ref 13 }
ptp1ColorFrameId	OBJECT IDENTIFIER ::= { ptp1Ref 14 }
ptp1DelayMechanism	OBJECT IDENTIFIER ::= { ptp1Ref 15 }
ptp1AmtConfiguration1	OBJECT IDENTIFIER ::= { ptp1Ref 16 }
ptp1AmtConfiguration2	OBJECT IDENTIFIER ::= { ptp1Ref 17 }
ptp1AmtConfiguration3	OBJECT IDENTIFIER ::= { ptp1Ref 18 }
ptp1AmtConfiguration4	OBJECT IDENTIFIER ::= { ptp1Ref 19 }
ptp1AmtConfiguration5	OBJECT IDENTIFIER ::= { ptp1Ref 20 }
ptp1AmtConfiguration6	OBJECT IDENTIFIER ::= { ptp1Ref 21 }
ptp1AmtConfiguration7	OBJECT IDENTIFIER ::= { ptp1Ref 22 }
ptp1AmtConfiguration8	OBJECT IDENTIFIER ::= { ptp1Ref 23 }
ptp1AsymmetricDelay	OBJECT IDENTIFIER ::= { ptp1Ref 24 }
ptp1DelayMsgInterval	OBJECT IDENTIFIER ::= { ptp1Ref 25 }
ptp1AnnounceDesirInt	OBJECT IDENTIFIER ::= { ptp1Ref 26 }
ptp1AnnounceReqdInt	OBJECT IDENTIFIER ::= { ptp1Ref 27 }
ptp1SyncDesirInt	OBJECT IDENTIFIER ::= { ptp1Ref 28 }
ptp1SyncReqdInt	OBJECT IDENTIFIER ::= { ptp1Ref 29 }
ptp1DlyMsgDesirInt	OBJECT IDENTIFIER ::= { ptp1Ref 30 }
ptp1DlyMsgReqdInt	OBJECT IDENTIFIER ::= { ptp1Ref 31 }
ptp1Bmca	OBJECT IDENTIFIER ::= { ptp1Ref 32 }

## 24. SNMP

ptp2Ref	OBJECT IDENTIFIER ::= { ptp 2 }
ptp2Mode	OBJECT IDENTIFIER ::= { ptp2Ref 1 }
ptp2ProfileType	OBJECT IDENTIFIER ::= { ptp2Ref 2 }
ptp2ProfileDefault	OBJECT IDENTIFIER ::= { ptp2Ref 3 }
ptp2Domain	OBJECT IDENTIFIER ::= { ptp2Ref 4 }
ptp2ComminucationMode	OBJECT IDENTIFIER ::= { ptp2Ref 5 }
ptp2AnnounceInterval	OBJECT IDENTIFIER ::= { ptp2Ref 6 }
ptp2SyncInterval	OBJECT IDENTIFIER ::= { ptp2Ref 7 }
ptp2AnnounceTimeout	OBJECT IDENTIFIER ::= { ptp2Ref 8 }
ptp2Priority1	OBJECT IDENTIFIER ::= { ptp2Ref 9 }
ptp2Priority2	OBJECT IDENTIFIER ::= { ptp2Ref 10 }
ptp2Step	OBJECT IDENTIFIER ::= { ptp2Ref 11 }
ptp2DefaultFrame	OBJECT IDENTIFIER ::= { ptp2Ref 12 }
ptp2DropFrameFlag	OBJECT IDENTIFIER ::= { ptp2Ref 13 }
ptp2ColorFrameId	OBJECT IDENTIFIER ::= { ptp2Ref 14 }
ptp2DelayMechanism	OBJECT IDENTIFIER ::= { ptp2Ref 15 }
ptp2Bmca	OBJECT IDENTIFIER ::= { ptp2Ref 32 }
ptpSystem	OBJECT IDENTIFIER ::= { lt4610 6 }
ptpSystemIpAddress	OBJECT IDENTIFIER ::= { ptpSystem 1 }
ptpSystemSubnetMask	OBJECT IDENTIFIER ::= { ptpSystem 2 }
ptpSystemGateway	OBJECT IDENTIFIER ::= { ptpSystem 3 }
ptpSystemSwitch	OBJECT IDENTIFIER ::= { ptpSystem 4 }
ptpSystemSfpSfpp	OBJECT IDENTIFIER ::= { ptpSystem 5 }
trap	OBJECT IDENTIFIER ::= { lt4610 100 }
target	OBJECT IDENTIFIER ::= { trap 1 }

\*1 It is "gps" when LT 4610SER01 is installed, and "gnss" when LT 4610SER04 is installed.

- ACCESS

ACCESS	Description
R/O	Read only
R/W	Read and write

## 24. SNMP

## 24.4.1 status Group

MIB	OID	SYNTAX	ACCESS	VALUE	Description
fanStat	status.1	INTEGER	R/O	1	OPERATION
				2	STOP
genlockStat	status.2	INTEGER	R/O	1	INTERNAL
				2	NO SIGNAL
				3	TRACKING
				4	LOCKED
				5	STAY IN SYNC
power1	status.3	INTEGER	R/O	1	OFF
				2	ON
power2	status.4	INTEGER	R/O	1	OFF
				2	ON
genlockFormatStat	status.5	INTEGER	R/O	1	1125/60I
				2	1125/59.94I
				3	1125/50I
				7	1125/30P
				8	1125/29.97P
				9	1125/25P
				10	1125/24P
				11	1125/23.98P
				15	1125/24PsF
				16	1125/23.98PsF
				21	750/60P
				22	750/59.94P
				23	750/50P
				24	750/30P
				25	750/29.97P
				26	750/25P
				27	750/24P
				28	750/23.98P
				41	NTSC BB
				42	NTSC BB+REF
				43	NTSC BB+ID
				44	NTSC BB+REF+ID
				45	NTSC BB+SETUP
				46	NTSC BB+S+REF
				47	NTSC BB+S+ID
				48	NTSC BB+S+R+ID
				49	525/59.94I
				50	525/59.94P
				61	PAL BB
				62	PAL BB+REF
				63	625/50I
				64	625/50P
100	UNKNOWN				

## 24. SNMP

## 24.4.2 genlockRef Group

MIB	OID	SYNTAX	ACCESS	VALUE	Description
genlockModeRef	genlockRef.1	INTEGER	R/W	1	INTERNAL
				2	GL FMT-AUTO
				3	GL FMT-MANUAL
				4	GPS (*1)
				5	10MHzCW
				6	PTP
genlockFormatRef	genlockRef.2	INTEGER	R/W	1	1125/60I
				2	1125/59.94I
				3	1125/50I
				7	1125/30P
				8	1125/29.97P
				9	1125/25P
				10	1125/24P
				11	1125/23.98P
				15	1125/24PsF
				16	1125/23.98PsF
				21	750/60P
				22	750/59.94P
				23	750/50P
				24	750/30P
				25	750/29.97P
				26	750/25P
				27	750/24P
				28	750/23.98P
				41	NTSC BB
				42	NTSC BB+REF
				43	NTSC BB+ID
				44	NTSC BB+REF+ID
				49	525/59.94I
				50	525/59.94P
				61	PAL BB
				62	PAL BB+REF
				63	625/50I
				64	625/50P
genlockSatelliteRef	genlockRef.3	INTEGER	R/W	1	GPS
				2	BDS

\*1 It is "gps" when LT 4610SER01 is installed, and "gnss" when LT 4610SER04 is installed.

24. SNMP

24.4.3 black\*Ref Group

MIB	OID	SYNTAX	ACCESS	VALUE	Description
black1FormatRef black2FormatRef black3FormatRef black4FormatRef black5FormatRef black6FormatRef	black1Ref.1 black2Ref.1 black3Ref.1 black4Ref.1 black5Ref.1 black6Ref.1	INTEGER	R/W	1	1125/60I
				2	1125/59.94I
				3	1125/50I
				7	1125/30P
				8	1125/29.97P
				9	1125/25P
				10	1125/24P
				11	1125/23.98P
				15	1125/24PsF
				16	1125/23.98PsF
				21	750/60P
				22	750/59.94P
				23	750/50P
				24	750/30P
				25	750/29.97P
				26	750/25P
				27	750/24P
				28	750/23.98P
				41	NTSC BB
				42	NTSC BB+REF
				43	NTSC BB+ID
				44	NTSC BB+REF+ID
				45	NTSC BB+SETUP
				46	NTSC BB+S+REF
				47	NTSC BB+S+ID
				48	NTSC BB+S+R+ID
				49	525/59.94I
				50	525/59.94P
				61	PAL BB
				62	PAL BB+REF
				63	625/50I
				64	625/50P
black1VtcRef black2VtcRef black3VtcRef black4VtcRef black5VtcRef black6VtcRef	black1Ref.2 black2Ref.2 black3Ref.2 black4Ref.2 black5Ref.2 black6Ref.2	INTEGER	R/W	1	OFF
				2	ON

## 24. SNMP

## 24.4.4 sdi\*Format Group

MIB	OID	SYNTAX	ACCESS	VALUE	Description
sdi1ImageRef sdi2ImageRef	sdi1Format.1 sdi2Format.1	INTEGER	R/W	1	720x487:SD
				2	720x576:SD
				3	1280x720:HD
				4	1920x1080:HD
				5	1280x720:3G-A
				6	1920x1080:3G-A
				7 (*1)	1920x1080:3G-B-DL
				8 (*1)	1920x1080:HD-DL
sdi1StructureRef sdi2StructureRef	sdi1Format.2 sdi2Format.2	INTEGER	R/W	1	422(YCbCr)10-bit
				2	422(YCbCr)12-bit
				3	444(YCbCr)10-bit
				4	444(YCbCr)12-bit
				5	444(RGB)10-bit
				6	444(RGB)12-bit
sdi1FramerateRef sdi2FramerateRef	sdi1Format.3 sdi2Format.3	INTEGER	R/W	1	1080/60I
				2	1080/59.94I
				3	1080/50I
				4	1080/60P
				5	1080/59.94P
				6	1080/50P
				7	1080/30P
				8	1080/29.97P
				9	1080/25P
				10	1080/24P
				11	1080/23.98P
				12	1080/30PsF
				13	1080/29.97PsF
				14	1080/25PsF
				15	1080/24PsF
				16	1080/23.98PsF
				21	720/60P
				22	720/59.94P
				23	720/50P
				24	720/30P
				25	720/29.97P
				26	720/25P
				27	720/24P
				28	720/23.98P
				49	525/59.94I
				63	625/50I

\*1 Cannot be set.

## 24. SNMP

### 24.4.5 sdi\*Timing Group

MIB	OID	SYNTAX	ACCESS	VALUE	Description
sdi1TimingVRef sdi2TimingVRef	sdi1Timing.2 sdi2Timing.2	INTEGER	R/W	±1124	-
sdi1TimingHRef sdi2TimingHRef	sdi1Timing.3 sdi2Timing.3	INTEGER	R/W	±4124	-

### 24.4.6 sdi\*Pattern Group

MIB	OID	SYNTAX	ACCESS	VALUE	Description
sdi1PatternRef sdi2PatternRef	sdi1Pattern.1 sdi2Pattern.1	INTEGER	R/W	1	COLOR BAR 100%
				2	COLOR BAR 75%
				3	COLOR BAR MULTI 100%
				4	COLOR BAR MULTI 75%
				5	COLOR BAR MULTI (+I)
				7	COLOR BAR SMPTE
				8	COLOR BAR EBU
				9	COLOR BAR BBC
				15	FLAT FIELD 100%
				17	FLAT FIELD 0%
				18	RED FIELD 100%
				19	GREEN FIELD 100%
				20	BLUE FIELD 100%
				23	CHECK FIELD
				27	OTHER1 (*1)
28	OTHER2 (*1)				
29	OTHER3 (*1)				
30	OTHER4 (*1)				
31	OTHER5 (*1)				

\*1 Cannot be set because it is reserved.

### 24.4.7 sdi\*Component Group

MIB	OID	SYNTAX	ACCESS	VALUE	Description
sdi1ComponentRef sdi2ComponentRef	sdi1Component.1 sdi2Component.1	INTEGER	R/W	1	<input type="checkbox"/> Y/G <input type="checkbox"/> Cb/B <input type="checkbox"/> Cr/R
				2	<input checked="" type="checkbox"/> Y/G <input type="checkbox"/> Cb/B <input type="checkbox"/> Cr/R
				3	<input type="checkbox"/> Y/G <input checked="" type="checkbox"/> Cb/B <input type="checkbox"/> Cr/R
				4	<input checked="" type="checkbox"/> Y/G <input checked="" type="checkbox"/> Cb/B <input type="checkbox"/> Cr/R
				5	<input type="checkbox"/> Y/G <input type="checkbox"/> Cb/B <input checked="" type="checkbox"/> Cr/R
				6	<input checked="" type="checkbox"/> Y/G <input type="checkbox"/> Cb/B <input checked="" type="checkbox"/> Cr/R
				7	<input type="checkbox"/> Y/G <input checked="" type="checkbox"/> Cb/B <input checked="" type="checkbox"/> Cr/R
				8	<input checked="" type="checkbox"/> Y/G <input checked="" type="checkbox"/> Cb/B <input checked="" type="checkbox"/> Cr/R

### 24.4.8 sdi\*SafetyArea Group

MIB	OID	SYNTAX	ACCESS	VALUE	Description
sdi1Safety90AreaRef sdi2Safety90AreaRef	sdi1SafetyArea.1 sdi2SafetyArea.1	INTEGER	R/W	1	OFF
				2	ON
sdi1Safety80AreaRef sdi2Safety80AreaRef	sdi1SafetyArea.2 sdi2SafetyArea.2	INTEGER	R/W	1	OFF
				2	ON
sdi1Safety43AreaRef sdi2Safety43AreaRef	sdi1SafetyArea.3 sdi2SafetyArea.3	INTEGER	R/W	1	OFF
				2	ON

## 24. SNMP

### 24.4.9 sdi\*Scroll Group

MIB	OID	SYNTAX	ACCESS	VALUE	Description
sdi1ScrollRef	sdi1Scroll.1	INTEGER	R/W	1	OFF
sdi2ScrollRef	sdi2Scroll.1			2	ON

### 24.4.10 sdi\*PatternChange Group

MIB	OID	SYNTAX	ACCESS	VALUE	Description
sdi1PatternChangeRef	sdi1PatternChange.1	INTEGER	R/W	1	OFF
sdi2PatternChangeRef	sdi2PatternChange.1			2	ON

### 24.4.11 sdi\*Id Group

MIB	OID	SYNTAX	ACCESS	VALUE	Description
sdi1IdRef	sdi1Id.1	INTEGER	R/W	1	OFF
sdi2IdRef	sdi2Id.1			2	ON

### 24.4.12 sdi\*Logo Group

MIB	OID	SYNTAX	ACCESS	VALUE	Description
sdi1LogoRef	sdi1Logo.1	INTEGER	R/W	1	OFF
sdi2LogoRef	sdi2Logo.1			2	ON

### 24.4.13 sdi\*Audio Group

MIB	OID	SYNTAX	ACCESS	VALUE	Description
sdi1AudioG1Ref	sdi1Audio.1	INTEGER	R/W	1	OFF
sdi2AudioG1Ref	sdi2Audio.1			2	ON
sdi1AudioG2Ref	sdi1Audio.2	INTEGER	R/W	1	OFF
sdi2AudioG2Ref	sdi2Audio.2			2	ON
sdi1AudioG3Ref	sdi1Audio.3	INTEGER	R/W	1	OFF
sdi2AudioG3Ref	sdi2Audio.3			2	ON
sdi1AudioG4Ref	sdi1Audio.4	INTEGER	R/W	1	OFF
sdi2AudioG4Ref	sdi2Audio.4			2	ON
sdi1AudioG5Ref	sdi1Audio.5	INTEGER	R/W	1	OFF
				2	ON
sdi1AudioG6Ref	sdi1Audio.6	INTEGER	R/W	1	OFF
				2	ON
sdi1AudioG7Ref	sdi1Audio.7	INTEGER	R/W	1	OFF
				2	ON
sdi1AudioG8Ref	sdi1Audio.8	INTEGER	R/W	1	OFF
				2	ON

### 24.4.14 Lipsync Group

MIB	OID	SYNTAX	ACCESS	VALUE	Description
sdi1LipsyncRef	Lipsync.1	INTEGER	R/W	1	OFF
				2	ON
sdi2LipsyncRef	Lipsync.2	INTEGER	R/W	1	OFF
				2	ON



## 24. SNMP

### 24.4.15 gpsStat Group (\*1)

MIB	OID	SYNTAX	ACCESS	VALUE	Description
antennaAlarm	gpsStat.1	INTEGER	R/O	1	NORMAL
				2	ALARM
gpsSignalAlarm	gpsStat.2	INTEGER	R/O	1	NORMAL
				2	ALARM
ltcSignalAlarm	gpsStat.3	INTEGER	R/O	1	NORMAL
				2	ALARM
cwSignalAlarm	gpsStat.4	INTEGER	R/O	1	NORMAL
				2	ALARM
satNumAlarm	gpsStat.5	INTEGER	R/O	1	NORMAL
				2	ALARM
satCnAlarm	gpsStat.6	INTEGER	R/O	1	NORMAL
				2	ALARM
vitcSignalAlarm	gpsStat.7	INTEGER	R/O	1	NORMAL
				2	ALARM

\*1 It is "gpsStat" when LT 4610SER01 is installed, and "gnssStat" when LT 4610SER04 is installed.

### 24.4.16 gpsRef Group (\*1)

MIB	OID	SYNTAX	ACCESS	VALUE	Description
satNumber	gpsRef.1	DisplayString	R/O	*/*	Number of used satellites/number of satellites in the line of view
satCnValue	gpsRef.2	DisplayString	R/O	*, *	MAX CN, MIN CN
gpsAntennaPower	gpsRef.3	INTEGER	R/W	1	OFF
				2	3.3V
				3	5V
gpsPlatformMode (*2)	gpsRef.4	INTEGER	R/W	1	STATIONARY
				2	AUTOMOTIVE
gpsCwInout	gpsRef.5	INTEGER	R/W	1	INPUT
				2	OUTPUT
gpsCwOutputFreq	gpsRef.6	INTEGER	R/W	1	CW
				2	1PPS

\*1 It is "gpsRef" when LT 4610SER01 is installed, and "gnssRef" when LT 4610SER04 is installed.

\*2 Not available when LT 4610SER04 is installed.

### 24.4.17 presetRef Group

MIB	OID	SYNTAX	ACCESS	VALUE	Description
powerOnRecall	presetRef.1	INTEGER	R/W	-1	OFF
				0 to 9	-
presetRecall	presetRef.2	INTEGER	R/W	0 to 9	-
presetStore	presetRef.3	INTEGER	R/W	0 to 9	-

### 24.4.18 target Group

MIB	OID	SYNTAX	ACCESS	VALUE	Description
trapManagerIp	target.1	IpAddress	R/W	*.*.*.*	Trap transmission destination
trapAction	target.2	INTEGER	R/W	1	disable
				2	enable

## 24. SNMP

## 24.4.19 sdi12g\*Format Group

MIB	OID	SYNTAX	ACCESS	VALUE	Description				
sdi12g1ImageRef	sdi12g1Format.1	INTEGER	R/W	1	720x487:SD				
				2	720x576:SD				
				3	1280x720:HD				
				4	1920x1080:HD				
				5	1280x720:3G-A				
				6	1920x1080:3G-A				
				7	2048x1080:3G-A				
				8	1920x1080:3G-B-DL				
				9	2048x1080:3G-B-DL				
				10	1920x1080:HD-DL				
				11	2048x1080:HD-DL				
				12	1280x720:3G-B-DS				
				13	1920x1080:3G-B-DS				
				14	1920x1080:3G-2K-A				
				15	2048x1080:3G-2K-A				
				16	1920x1080:3G-2K-B				
				17	2048x1080:3G-2K-B				
				18	3840x2160:3G-4K-DS-SQD				
				19	3840x2160:3G-4K-DS-2SI				
				20	4096x2160:3G-4K-DS-SQD				
				21	4096x2160:3G-4K-DS-2SI				
				22	3840x2160:HD-QL-SQD				
				24	4096x2160:HD-QL-SQD				
				26	3840x2160:3G-QL-A-SQD				
				27	3840x2160:3G-QL-A-2SI				
				28	4096x2160:3G-QL-A-SQD				
				29	4096x2160:3G-QL-A-2SI				
				30	3840x2160:3G-QL-B-DL-SQD				
				31	3840x2160:3G-QL-B-DL-2SI				
				32	4096x2160:3G-QL-B-DL-SQD				
				33	4096x2160:3G-QL-B-DL-2SI				
				34	3840x2160:12G-A				
				35	4096x2160:12G-A				
				38	7680x4320:12G-QL-A				
				sdi12g1StructureRef	sdi12g1Format.2	INTEGER	R/W	1	422(YCbCr)10-bit
								2	422(YCbCr)12-bit
								3	444(YCbCr)10-bit
								4	444(YCbCr)12-bit
5	444(RGB)10-bit								
6	444(RGB)12-bit								
sdi12g1FramerateRef	sdi12g1Format.3	INTEGER	R/W	1	60I				
				2	59.94I				
				3	50I				
				4	60P				
				5	59.94P				
				6	50P				
				7	30P				
				8	29.97P				
				9	25P				
				10	24P				
				11	23.98P				
				12	30PsF				

## 24. SNMP

MIB	OID	SYNTAX	ACCESS	VALUE	Description
				13	29.97PsF
				14	25PsF
				15	24PsF
				16	23.98PsF
				17	48P
				18	47.95P

### 24.4.20 sdi12g\*Timing Group

MIB	OID	SYNTAX	ACCESS	VALUE	Description
sdi12g1TimingVRef sdi12g2TimingVRef sdi12g3TimingVRef sdi12g4TimingVRef	sdi12g1Timing.2 sdi12g2Timing.2 sdi12g3Timing.2 sdi12g4Timing.2	INTEGER	R/W	±1124	-
sdi12g1TimingHRef sdi12g2TimingHRef sdi12g3TimingHRef sdi12g4TimingHRef	sdi12g1Timing.3 sdi12g2Timing.3 sdi12g3Timing.3 sdi12g4Timing.3	INTEGER	R/W	±4124	-

### 24.4.21 sdi12g\*Pattern Group

MIB	OID	SYNTAX	ACCESS	VALUE	Description
sdi12g1PtnFixRef sdi12g2PtnFixRef sdi12g3PtnFixRef sdi12g4PtnFixRef	sdi12g1Pattern.1 sdi12g2Pattern.1 sdi12g3Pattern.1 sdi12g4Pattern.1	INTEGER	R/W	1	COLOR BAR 100%
				2	COLOR BAR 75%
				3	COLOR BAR MULTI 100%
				4	COLOR BAR MULTI 75%
				5	COLOR BAR MULTI (+I)
				6	COLOR BAR SMPTE
				7	COLOR BAR EBU
				8	COLOR BAR BBC
				9	FLAT FIELD 100%
				10	FLAT FIELD 0%
				11	RED FIELD 100%
				12	GREEN FIELD 100%
				13	BLUE FIELD 100%
				14	CHECK FIELD
				15	COLOR BAR UHDTV STD-B66-2

### 24.4.22 sdi12g\*Component Group

MIB	OID	SYNTAX	ACCESS	VALUE	Description
sdi12g1ComponentRef	sdi12g1Component.1	INTEGER	R/W	1	<input type="checkbox"/> Y/G <input type="checkbox"/> Cb/B <input type="checkbox"/> Cr/R
				2	<input checked="" type="checkbox"/> Y/G <input type="checkbox"/> Cb/B <input type="checkbox"/> Cr/R
				3	<input type="checkbox"/> Y/G <input checked="" type="checkbox"/> Cb/B <input type="checkbox"/> Cr/R
				4	<input checked="" type="checkbox"/> Y/G <input checked="" type="checkbox"/> Cb/B <input type="checkbox"/> Cr/R
				5	<input type="checkbox"/> Y/G <input type="checkbox"/> Cb/B <input checked="" type="checkbox"/> Cr/R
				6	<input checked="" type="checkbox"/> Y/G <input type="checkbox"/> Cb/B <input checked="" type="checkbox"/> Cr/R
				7	<input type="checkbox"/> Y/G <input checked="" type="checkbox"/> Cb/B <input checked="" type="checkbox"/> Cr/R
				8	<input checked="" type="checkbox"/> Y/G <input checked="" type="checkbox"/> Cb/B <input checked="" type="checkbox"/> Cr/R

## 24. SNMP

### 24.4.23 sdi12g\*SafetyArea Group

MIB	OID	SYNTAX	ACCESS	VALUE	Description
sdi12g1Safety90AreaRef	sdi12g1SafetyArea.1	INTEGER	R/W	1	OFF
				2	ON
sdi12g1Safety80AreaRef	sdi12g1SafetyArea.2	INTEGER	R/W	1	OFF
				2	ON
sdi12g1Safety43AreaRef	sdi12g1SafetyArea.3	INTEGER	R/W	1	OFF
				2	ON

### 24.4.24 sdi12g\*Scroll Group

MIB	OID	SYNTAX	ACCESS	VALUE	Description
sdi12g1ScrollRef	sdi12g1Scroll.1	INTEGER	R/W	1	OFF
				2	ON
Sdi12g1ScrollVspdRef	sdi12g1Scroll.2	INTEGER	R/W	±256	
Sdi12g1ScrollHspdRef	sdi12g1Scroll.3	INTEGER	R/W	±256	

### 24.4.25 sdi12g\*PatternChange Group

MIB	OID	SYNTAX	ACCESS	VALUE	Description
Sdi12g1PtnChangeRef	sdi12g1PatternChange.1	INTEGER	R/W	1	OFF
				2	ON
sdi12g1PtnChangeSpdRef	sdi12g1PatternChange.2	INTEGER	R/W	+255	

## 24. SNMP

## 24.4.26 sdi12g\*Id Group

MIB	OID	SYNTAX	ACCESS	VALUE	Description
sdi12g1IdRef	sdi12g1Id.1	INTEGER	R/W	1	OFF
sdi12g2IdRef	sdi12g2Id.1			2	ON
sdi12g3IdRef	sdi12g3Id.1				
sdi12g4IdRef	sdi12g4Id.1				
sdi12g1IdVposiRef	sdi12g1Id.2	INTEGER	R/W	+4319	
sdi12g2IdVposiRef	sdi12g2Id.2				
sdi12g3IdVposiRef	sdi12g3Id.2				
sdi12g4IdVposiRef	sdi12g4Id.2				
sdi12g1IdHposiRef	sdi12g1Id.3	INTEGER	R/W	+7679	
sdi12g2IdHposiRef	sdi12g2Id.3				
sdi12g3IdHposiRef	sdi12g3Id.3				
sdi12g4IdHposiRef	sdi12g4Id.3				
sdi12g1IdSizeRef	sdi12g1Id.4	INTEGER	R/W	1	x1
sdi12g2IdSizeRef	sdi12g2Id.4			2	x2
sdi12g3IdSizeRef	sdi12g3Id.4			3	x4
sdi12g4IdSizeRef	sdi12g4Id.4			4	x8
sdi12g1IdLevelRef	sdi12g1Id.5	INTEGER	R/W	1	100%
sdi12g2IdLevelRef	sdi12g2Id.5			2	75%
sdi12g3IdLevelRef	sdi12g3Id.5				
sdi12g4IdLevelRef	sdi12g4Id.5				
sdi12g1IdBlink	sdi12g1Id.6	Aggregate	---	---	---
sdi12g2IdBlink	sdi12g2Id.6				
sdi12g3IdBlink	sdi12g3Id.6				
sdi12g4IdBlink	sdi12g4Id.6				
sdi12g1BlinkRef	sdi12g1IdBlink.1	INTEGER	R/W	1	OFF
sdi12g2BlinkRef	sdi12g2IdBlink.1			2	ON
sdi12g3BlinkRef	sdi12g3IdBlink.1				
sdi12g4BlinkRef	sdi12g4IdBlink.1				
sdi12g1BlinkOntimeRef	sdi12g1IdBlink.2	INTEGER	R/W	+9	
sdi12g2BlinkOntimeRef	sdi12g2IdBlink.2				
sdi12g3BlinkOntimeRef	sdi12g3IdBlink.2				
sdi12g4BlinkOntimeRef	sdi12g4IdBlink.2				
sdi12g1BlinkOfftimeRef	sdi12g1IdBlink.3	INTEGER	R/W	+9	
sdi12g2BlinkOfftimeRef	sdi12g2IdBlink.3				
sdi12g3BlinkOfftimeRef	sdi12g3IdBlink.3				
sdi12g4BlinkOfftimeRef	sdi12g4IdBlink.3				
sdi12g1IdScroll	sdi12g1Id.7	Aggregate	---	---	---
sdi12g2IdScroll	sdi12g2Id.7				
sdi12g3IdScroll	sdi12g3Id.7				
sdi12g4IdScroll	sdi12g4Id.7				
sdi12g1IdScrollRef	sdi12g1IdScroll.1	INTEGER	R/W	1	OFF
sdi12g2IdScrollRef	sdi12g2IdScroll.1			2	ON
sdi12g3IdScrollRef	sdi12g3IdScroll.1				
sdi12g4IdScrollRef	sdi12g4IdScroll.1				
sdi12g1IdScrollSpdRef	sdi12g1IdScroll.2	INTEGER	R/W	±256	
sdi12g2IdScrollSpdRef	sdi12g2IdScroll.2				
sdi12g3IdScrollSpdRef	sdi12g3IdScroll.2				
sdi12g4IdScrollSpdRef	sdi12g4IdScroll.2				

## 24.4.27 sdi12g\*Logo Group

MIB	OID	SYNTAX	ACCESS	VALUE	Description
sdi12g1LogoRef	sdi12g1Logo.1	INTEGER	R/W	1	OFF
sdi12g2LogoRef	sdi12g2Logo.1			2	ON
sdi12g3LogoRef	sdi12g3Logo.1				
sdi12g4LogoRef	sdi12g4Logo.1				
sdi12g1LogoSelRef	sdi12g1Logo.2	INTEGER	R/W	1..4	
sdi12g2LogoSelRef	sdi12g2Logo.2				
sdi12g3LogoSelRef	sdi12g3Logo.2				
sdi12g4LogoSelRef	sdi12g4Logo.2				
sdi12g1LogoVposiRef	sdi12g1Logo.3	INTEGER	R/W	+4319	
sdi12g2LogoVposiRef	sdi12g2Logo.3				
sdi12g3LogoVposiRef	sdi12g3Logo.3				
sdi12g4LogoVposiRef	sdi12g4Logo.3				
sdi12g1LogoHposiRef	sdi12g1Logo.4	INTEGER	R/W	+7679	
sdi12g2LogoHposiRef	sdi12g2Logo.4				
sdi12g3LogoHposiRef	sdi12g3Logo.4				
sdi12g4LogoHposiRef	sdi12g4Logo.4				
sdi12g1LogoLevel	sdi12g1Logo.5	Aggregate	---	---	---
sdi12g2LogoLevel	sdi12g2Logo.5				
sdi12g3LogoLevel	sdi12g3Logo.5				
sdi12g4LogoLevel	sdi12g4Logo.5				
sdi12g1LogoLevelLv0Ref	sdi12g1LogoLevel.1	INTEGER	R/W	100h . EB0h	
sdi12g2LogoLevelLv0Ref	sdi12g2LogoLevel.1				
sdi12g3LogoLevelLv0Ref	sdi12g3LogoLevel.1				
sdi12g4LogoLevelLv0Ref	sdi12g4LogoLevel.1				
sdi12g1LogoLevelLv1Ref	sdi12g1LogoLevel.2	INTEGER	R/W	100h . EB0h	
sdi12g2LogoLevelLv1Ref	sdi12g2LogoLevel.2				
sdi12g3LogoLevelLv1Ref	sdi12g3LogoLevel.2				
sdi12g4LogoLevelLv1Ref	sdi12g4LogoLevel.2				
sdi12g1LogoLevelLv2Ref	sdi12g1LogoLevel.3	INTEGER	R/W	100h . EB0h	
sdi12g2LogoLevelLv2Ref	sdi12g2LogoLevel.3				
sdi12g3LogoLevelLv2Ref	sdi12g3LogoLevel.3				
sdi12g4LogoLevelLv2Ref	sdi12g4LogoLevel.3				
sdi12g1LogoLevelLv3Ref	sdi12g1LogoLevel.4	INTEGER	R/W	100h . EB0h	
sdi12g2LogoLevelLv3Ref	sdi12g2LogoLevel.4				
sdi12g3LogoLevelLv3Ref	sdi12g3LogoLevel.4				
sdi12g4LogoLevelLv3Ref	sdi12g4LogoLevel.4				
sdi12g1LogoBg	sdi12g1Logo.6	Aggregate	---	---	---
sdi12g2LogoBg	sdi12g2Logo.6				
sdi12g3LogoBg	sdi12g3Logo.6				
sdi12g4LogoBg	sdi12g4Logo.6				
sdi12g1BgRef	sdi12g1LogoBg.1	INTEGER	R/W	1	OFF
sdi12g2BgRef	sdi12g2LogoBg.1			2	ON
sdi12g3BgRef	sdi12g3LogoBg.1				
sdi12g4BgRef	sdi12g4LogoBg.1				
sdi12g1BgYLevelRef	sdi12g1LogoBg.2	INTEGER	R/W	100h . EB0h	Cannot be set.
sdi12g2BgYLevelRef	sdi12g2LogoBg.2				
sdi12g3BgYLevelRef	sdi12g3LogoBg.2				
sdi12g4BgYLevelRef	sdi12g4LogoBg.2				
sdi12g1BgCbLevelRef	sdi12g1LogoBg.3	INTEGER	R/W	100h . EB0h	Cannot be set.
sdi12g2BgCbLevelRef	sdi12g2LogoBg.3				
sdi12g3BgCbLevelRef	sdi12g3LogoBg.3				
sdi12g4BgCbLevelRef	sdi12g4LogoBg.3				
sdi12g1BgCrLevelRef	sdi12g1LogoBg.4	INTEGER	R/W	100h . EB0h	Cannot be set.
sdi12g2BgCrLevelRef	sdi12g2LogoBg.4				
sdi12g3BgCrLevelRef	sdi12g3LogoBg.4				
sdi12g4BgCrLevelRef	sdi12g4LogoBg.4				

24. SNMP

24.4.28 sdi12g\*MvBox Group

MIB	OID	SYNTAX	ACCESS	VALUE	Description
sdi12g1MvBoxRef	sdi12g1MvBox.1	INTEGER	R/W	1	OFF
				2	ON
sdi12g1MvBoxColorRef	sdi12g1MvBox.2	INTEGER	R/W	1	WHITE
				2	YELLOW
				3	CYAN
				4	GREEN
				5	BLUE
				6	RED
				7	MAGENTA
				8	BLACK
sdi12g1MvBoxVspdRef	sdi12g1MvBox.3	INTEGER	R/W	1	LOW
				2	MIDDLE
				3	HIGH
sdi12g1MvBoxHspdRef	sdi12g1MvBox.4	INTEGER	R/W	1	LOW
				2	MIDDLE
				3	HIGH
sdi12g1MvBoxVsizeRef	sdi12g1MvBox.5	INTEGER	R/W	1	SIZE 1
				2	SIZE 2
				3	SIZE 3
				4	SIZE 4
				5	SIZE 5
sdi12g1MvBoxHsizeRef	sdi12g1MvBox.6	INTEGER	R/W	1	SIZE 1
				2	SIZE 2
				3	SIZE 3
				4	SIZE 4
				5	SIZE 5

## 24.4.29 sdi12g \*Audio Group

MIB	OID	SYNTAX	ACCESS	VALUE	Description
sdi12g1AudioG1Ref	sdi12g1Audio.1	INTEGER	R/W	1	OFF
sdi12g2AudioG1Ref	sdi12g2Audio.1			2	ON
sdi12g3AudioG1Ref	sdi12g3Audio.1				
sdi12g4AudioG1Ref	sdi12g4Audio.1				
sdi12g1AudioG2Ref	sdi12g1Audio.2	INTEGER	R/W	1	OFF
sdi12g2AudioG2Ref	sdi12g2Audio.2			2	ON
sdi12g3AudioG2Ref	sdi12g3Audio.2				
sdi12g4AudioG2Ref	sdi12g4Audio.2				
sdi12g1AudioG3Ref	sdi12g1Audio.3	INTEGER	R/W	1	OFF
sdi12g2AudioG3Ref	sdi12g2Audio.3			2	ON
sdi12g3AudioG3Ref	sdi12g3Audio.3				
sdi12g4AudioG3Ref	sdi12g4Audio.3				
sdi12g1AudioG4Ref	sdi12g1Audio.4	INTEGER	R/W	1	OFF
sdi12g2AudioG4Ref	sdi12g2Audio.4			2	ON
sdi12g3AudioG4Ref	sdi12g3Audio.4				
sdi12g4AudioG4Ref	sdi12g4Audio.4				
sdi12g1AudioG5Ref	sdi12g1Audio.5	INTEGER	R/W	1	OFF
sdi12g3AudioG5Ref	sdi12g3Audio.5			2	ON
sdi12g1AudioG6Ref	sdi12g1Audio.6	INTEGER	R/W	1	OFF
sdi12g3AudioG6Ref	sdi12g3Audio.6			2	ON
sdi12g1AudioG7Ref	sdi12g1Audio.7	INTEGER	R/W	1	OFF
sdi12g3AudioG7Ref	sdi12g3Audio.7			2	ON
sdi12g1AudioG8Ref	sdi12g1Audio.8	INTEGER	R/W	1	OFF
sdi12g3AudioG8Ref	sdi12g3Audio.8			2	ON

## 24.4.30 sdi12g\*Lipsync Group

MIB	OID	SYNTAX	ACCESS	VALUE	Description
sdi12g1LipsyncRef	sdi12g1Lipsync.1	INTEGER	R/W	1	OFF
sdi12g2LipsyncRef	sdi12g2Lipsync.1			2	ON
sdi12g3LipsyncRef	sdi12g3Lipsync.1				
sdi12g4LipsyncRef	sdi12g4Lipsync.1				

## 24.4.31 ptp\*Mode Group

MIB	OID	SYNTAX	ACCESS	VALUE	Description
ptp1ModeRef	ptp1Mode.1	INTEGER	R/W	1	ENABLE MASTER
ptp2ModeRef	ptp2Mode.1			2	DISABLE MASTER
				3	SLAVE

## 24.4.32 ptp\*ProfileType Group

MIB	OID	SYNTAX	ACCESS	VALUE	Description
ptp1ProfileTypeRef	ptp1ProfileType.1	INTEGER	R/W	1	ST2059
ptp2ProfileTypeRef	ptp2ProfileType.1			2	AES67
				3	GENERAL



## 24.4.33 ptp\*ProfileDefault Group

MIB	OID	SYNTAX	ACCESS	VALUE	Description
ptp1ProfileDefaultRef ptp2ProfileDefaultRef	ptp1ProfileDefault.1 ptp2ProfileDefault.1	INTEGER	R/W	0	Set default according to ProfileType.

## 24.4.34 ptp\*Domain Group

MIB	OID	SYNTAX	ACCESS	VALUE	Description
ptp1DomainRef ptp2DomainRef	ptp1Domain.1 ptp2Domain.1	INTEGER	R/W	0 to 255	

## 24.4.35 ptp\*ComminucationMode Group

MIB	OID	SYNTAX	ACCESS	VALUE	Description
ptp1ComminucationMode Ref ptp2ComminucationMode Ref	ptp1ComminucationMod e.1 ptp2ComminucationMod e.1	INTEGER	R/W	1	MIXED SMPTE
				2	MIXED SMPTE w/o NE
				3	UNICAST
				4	MULTICAST

## 24.4.36 ptp\*AnnoumceInterval Group

MIB	OID	SYNTAX	ACCESS	VALUE	Description
ptp1AnnoumceIntervalRef ptp2AnnoumceIntervalRef	ptp1AnnoumceInterval. 1 ptp2AnnoumceInterval. 1	INTEGER	R/W	1	0.125s 8Hz
				2	0.25s 4Hz
				3	0.5s 2Hz
				4	1s 1Hz
				5	2s 0.5Hz
				6	4s 0.25Hz
				7	8s 0.125Hz
				8	16s 0.0625Hz

## 24.4.37 ptp\*SyncInterval Group

MIB	OID	SYNTAX	ACCESS	VALUE	Description
ptp1SyncIntervalRef ptp2SyncIntervalRef	ptp1SyncInterval.1 ptp2SyncInterval.1	INTEGER	R/W	1	0.0078s 128Hz
				2	0.015s 64Hz
				3	0.0312s 32Hz
				4	0.0625s 16Hz
				5	0.125s 8Hz
				6	0.25s 4Hz
				7	0.5s 2Hz
				8	1s 1Hz
				9	2s 0.5Hz
				10	4s 0.25Hz
				11	8s 0.125Hz
				12	16s 0.0625Hz

## 24.4.38 ptp\*AnnounceTimeout Group

MIB	OID	SYNTAX	ACCESS	VALUE	Description
ptp1AnnounceTimeoutRef ptp2AnnounceTimeoutRef	ptp1AnnounceTimeout. 1 ptp2AnnounceTimeout. 1	INTEGER	R/W	2 to 10	

## 24. SNMP

## 24.4.39 ptp\*Priority1 Group

MIB	OID	SYNTAX	ACCESS	VALUE	Description
ptp1Priority1Ref ptp2Priority1Ref	ptp1Priority1.1 ptp2Priority1.1	INTEGER	R/W	0 to 255	

## 24.4.40 ptp\*Priority2 Group

MIB	OID	SYNTAX	ACCESS	VALUE	Description
ptp1Priority2Ref ptp2Priority2Ref	ptp1Priority2.1 ptp2Priority2.1	INTEGER	R/W	0 to 255	

## 24.4.41 ptp\*Step Group

MIB	OID	SYNTAX	ACCESS	VALUE	Description
ptp1StepRef ptp2StepRef	ptp1Step.1 ptp2Step.1	INTEGER	R/W	1 2	ONE STEP TWO STEP

## 24.4.42 ptp\*DefaultFrame Group

MIB	OID	SYNTAX	ACCESS	VALUE	Description
tp1DefaultFrameRef ptp2DefaultFrameRef	ptp1DefaultFrame.1 ptp2DefaultFrame.1	INTEGER	R/W	2 3 4 5 6 7 8 9 10 11 12 13 14 15 16	23.98 24 25 29.97 30 47.95 48 50 59.94 60 71.92 72 100 119.9 120

## 24.4.43 ptp\*DropFrameFlag Group

MIB	OID	SYNTAX	ACCESS	VALUE	Description
p1DropFrameFlagRef ptp2DropFrameFlagRef	ptp1DropFrameFlag.1 ptp2DropFrameFlag.1	INTEGER	R/W	1 2	ENABLE DISABLE

## 24.4.44 ptp\*ColorFrameId Group

MIB	OID	SYNTAX	ACCESS	VALUE	Description
ptp1ColorFrameIdRef ptp2ColorFrameIdRef	ptp1ColorFrameId.1 ptp2ColorFrameId.1	INTEGER	R/W	1 2	ENABLE DISABLE

## 24.4.45 ptp\*DelayMechanism Group

MIB	OID	SYNTAX	ACCESS	VALUE	Description
ptp1DelayMechanismRef ptp2DelayMechanismRef	ptp1DelayMechanism.1 ptp2DelayMechanism.1	INTEGER	R/W	1 2	END TO END PEER TO PEER

## 24.4.46 ptp\*AmConfiguration1 Group

MIB	OID	SYNTAX	ACCESS	VALUE	Description
ptp1AmConfiguration1Ip	ptp1AmConfiguration1.1	IpAddress	R/W	*.*.*	Setting the Address

## 24.4.47 ptp\*AmConfiguration2 Group

MIB	OID	SYNTAX	ACCESS	VALUE	Description
ptp1AmConfiguration2Ip	ptp1AmConfiguration2.1	IpAddress	R/W	*.*.*	Setting the Address

## 24.4.48 ptp\*AmConfiguration3 Group

MIB	OID	SYNTAX	ACCESS	VALUE	Description
ptp1AmConfiguration3Ip	ptp1AmConfiguration3.1	IpAddress	R/W	*.*.*	Setting the Address

## 24.4.49 ptp\*AmConfiguration4 Group

MIB	OID	SYNTAX	ACCESS	VALUE	Description
ptp1AmConfiguration4Ip	ptp1AmConfiguration4.1	IpAddress	R/W	*.*.*	Setting the Address

## 24.4.50 ptp\*AmConfiguration5 Group

MIB	OID	SYNTAX	ACCESS	VALUE	Description
ptp1AmConfiguration5Ip	ptp1AmConfiguration5.1	IpAddress	R/W	*.*.*	Setting the Address

## 24.4.51 ptp\*AmConfiguration6 Group

MIB	OID	SYNTAX	ACCESS	VALUE	Description
ptp1AmConfiguration6Ip	ptp1AmConfiguration6.1	IpAddress	R/W	*.*.*	Setting the Address

## 24.4.52 ptp\*AmConfiguration7 Group

MIB	OID	SYNTAX	ACCESS	VALUE	Description
ptp1AmConfiguration7Ip	ptp1AmConfiguration7.1	IpAddress	R/W	*.*.*	Setting the Address

## 24.4.53 ptp\*AmConfiguration8 Group

MIB	OID	SYNTAX	ACCESS	VALUE	Description
ptp1AmConfiguration8Ip	ptp1AmConfiguration8.1	IpAddress	R/W	*.*.*	Setting the Address

## 24.4.54 ptp\*AsymmetricDelay Group

MIB	OID	SYNTAX	ACCESS	VALUE	Description
ptp1AsymmetricDelayRef	ptp1AsymmetricDelay.1	INTEGER	R/W	-20000 to 20000	Delay value (nsec)

## 24. SNMP

## 24.4.55 ptp\*DelayMsgInterval Group

MIB	OID	SYNTAX	ACCESS	VALUE	Description
ptp1DelayMsgIntervalRef	ptp1DelayMsgInterval.1	INTEGER	R/W	1	0.0078s 128Hz
				2	0.015s 64Hz
				3	0.0312s 32Hz
				4	0.0625s 16Hz
				5	0.125s 8Hz
				6	0.25s 4Hz
				7	0.5s 2Hz
				8	1s 1Hz
				9	2s 0.5Hz
				10	4s 0.25Hz
				11	8s 0.125Hz
				12	16s 0.0625Hz

## 24.4.56 ptp\*AnnounceDesirInt Group

MIB	OID	SYNTAX	ACCESS	VALUE	Description
ptp1AnnounceDesirIntRef	ptp1AnnounceDesirInt.1	INTEGER	R/W	1	0.125s 8Hz
				2	0.25s 4Hz
				3	0.5s 2Hz
				4	1s 1Hz
				5	2s 0.5Hz
				6	4s 0.25Hz
				7	8s 0.125Hz
				8	16s 0.0625Hz

## 24.4.57 ptp\*AnnounceReqdInt Group

MIB	OID	SYNTAX	ACCESS	VALUE	Description
ptp1AnnounceReqdIntRef	ptp1AnnounceReqdInt.1	INTEGER	R/W	1	0.125s 8Hz
				2	0.25s 4Hz
				3	0.5s 2Hz
				4	1s 1Hz
				5	2s 0.5Hz
				6	4s 0.25Hz
				7	8s 0.125Hz
				8	16s 0.0625Hz

## 24. SNMP

### 24.4.58 ptp\*SyncDesirInt Group

MIB	OID	SYNTAX	ACCESS	VALUE	Description
ptp1SyncDesirIntRef	ptp1SyncDesirInt.1	INTEGER	R/W	1	0.0078s 128Hz
				2	0.015s 64Hz
				3	0.0312s 32Hz
				4	0.0625s 16Hz
				5	0.125s 8Hz
				6	0.25s 4Hz
				7	0.5s 2Hz
				8	1s 1Hz
				9	2s 0.5Hz
				10	4s 0.25Hz
				11	8s 0.125Hz

### 24.4.59 ptp\*SyncReqdInt Group

MIB	OID	SYNTAX	ACCESS	VALUE	Description
ptp1SyncReqdIntRef	ptp1SyncReqdInt.1	INTEGER	R/W	1	0.0078s 128Hz
				2	0.015s 64Hz
				3	0.0312s 32Hz
				4	0.0625s 16Hz
				5	0.125s 8Hz
				6	0.25s 4Hz
				7	0.5s 2Hz
				8	1s 1Hz
				9	2s 0.5Hz
				10	4s 0.25Hz
				11	8s 0.125Hz

### 24.4.60 ptp\*DlyMsgDesirInt Group

MIB	OID	SYNTAX	ACCESS	VALUE	Description
ptp1DlyMsgDesirIntRef	ptp1DlyMsgDesirInt.1	INTEGER	R/W	1	0.0078s 128Hz
				2	0.015s 64Hz
				3	0.0312s 32Hz
				4	0.0625s 16Hz
				5	0.125s 8Hz
				6	0.25s 4Hz
				7	0.5s 2Hz
				8	1s 1Hz
				9	2s 0.5Hz
				10	4s 0.25Hz
				11	8s 0.125Hz
				12	16s 0.0625Hz

## 24.4.61 ptp\*DlyMsgReqdInt Group

MIB	OID	SYNTAX	ACCESS	VALUE	Description
ptp1DlyMsgReqdIntRef	ptp1DlyMsgReqdInt.1	INTEGER	R/W	1	0.0078s 128Hz
				2	0.015s 64Hz
				3	0.0312s 32Hz
				4	0.0625s 16Hz
				5	0.125s 8Hz
				6	0.25s 4Hz
				7	0.5s 2Hz
				8	1s 1Hz
				9	2s 0.5Hz
				10	4s 0.25Hz
				11	8s 0.125Hz
				12	16s 0.0625Hz

## 24.4.62 ptp\*Bmca Group

MIB	OID	SYNTAX	ACCESS	VALUE	Description
ptp1BmcaRef	ptp1Bmca.1	INTEGER	R/W	1	ENABLE
ptp2BmcaRef	ptp2Bmca.1			2	DISABLE

## 24.4.63 ptpSystemIpAddress Group

MIB	OID	SYNTAX	ACCESS	VALUE	Description
ptpSystemIpAddressRef	ptpSystemIpAddress.1	IpAddress	R/W	*.*.*.*	PTP ETHERNET IP address

## 24.4.64 ptpSystemSubnetMask Group

MIB	OID	SYNTAX	ACCESS	VALUE	Description
ptpSystemSubnetMaskRef	ptpSystemSubnetMask.1	IpAddress	R/W	*.*.*.*	PTP ETHERNET subnet mask

## 24.4.65 ptpSystemGateway Group

MIB	OID	SYNTAX	ACCESS	VALUE	Description
ptpSystemGatewayRef	ptpSystemGateway.1	IpAddress	R/W	*.*.*.*	PTP ETHERNET gateway

## 24.4.66 ptpSystemSwitch Group

MIB	OID	SYNTAX	ACCESS	VALUE	Description
ptpSystemSwitchRef	ptpSystemSwitch.1	INTEGER	R/W	1	FULLY CROSS-LINK
				2	ISOLATED
				3	MIRROR RJ45 TO SFP

## 24.4.67 ptpSystemSfpSfpp Group

MIB	OID	SYNTAX	ACCESS	VALUE	Description
ptpSystemSfpSfppRef	ptpSystemSfpSfpp.1	INTEGER	R/W	1	SFP
				2	SFP+

## 24.5 Extended TRAP

## • index 1

OID : iso(1).org(3).dod(6).internet(1).mib-2(1).system(1).sysUpTime(1).0

Syntax : TimeTicks

Range: 1 to 4294967295 (overflow occurs if this range is exceeded)

Description: Elapsed time after starting the SNMP agent

## • index 2

OID : iso(1).org(3).dod(6).internet(1).snmpV2(6).snmpModules(3).  
snmpMIB(1).snmpMIBObjects(1).snmpTrap(4).snmpTrapOID(1).0

Syntax : Object Identifier

Description: Trap identification field

## • index 3

OID : leader(20111).lt4610(36).notification(0).trapStr(2).trapCounter(1).0

Syntax : Counter32

Range: 1 to 4294967295

Description: The total number of enterprise traps sent after starting up

## • index 4

OID : leader(20111).lt4610(36).notification(0).trapStr(2).  
trapIntTimestamp(2).0

Syntax : DisplayString(1..20)

Range: Up to 20 characters

Description: Date and time of error occurrence

## • index 5

OID : leader(20111).lt4610(36).notification(0).trapContent(1).error(1).X  
leader(20111).lt4610(36).notification(0).trapContent(1).normal(2).X

Syntax : STRING

Range: Up to 16 characters

Description: Error information character string

The OID or trapContent(1).error(1).X and error information character string  
when an error occurs or

the OID of trapContent(1).normal(2).X and error information character string  
when the error recovers

are sent.

Error Number (*1)	Error Information Character String	Description
1	FAN_STATUS	Fan status error detection
2	GENLOCK_STATUS	Genlock status error detection
3	POWER1_STATUS	Power supply 1 error detection
4	POWER2_STATUS	Power supply 2 error detection
5	GNSS_ANTENNA_STATUS	GNSS antenna error detection
6	GNSS_SIGNAL_STATUS	GNSS signal error detection

\*1 OID number of error(1) and that of normal(2) of trapContent(1).

## 25. APPENDIX

### 25.1 List of Settings

Settings may not be displayed depending on other settings or options. In addition, the available values that you can select and the variable range may vary depending on other settings or options. For details, see the LT 4610 / LT 4611 instruction manual.

#### 25.1.1 GENLOCK Menu

Setting	Value	Factory Default Value
GENLOCK MODE	INTERNAL / GL FMT-AUTO / GL FMT-MANUAL / GPS / GNSS / 10MHzCW / PTP	INTERNAL
GENLOCK NTSC	NTSC BB / NTSC BB+REF / NTSC BB+ID / NTSC BB+REF+ID	NTSC BB
GENLOCK PAL	PAL BB / PAL BB+REF	
GENLOCK COMPONENT	525/59.94I / 525/59.94P / 625/50I / 625/50P	
GENLOCK 1125:HD	1125/60I / 1125/59.94I / 1125/50I / 1125/30P / 1125/29.97P / 1125/25P / 1125/24P / 1125/23.98P / 1125/24PsF / 1125/23.98PsF	
GENLOCK 750:HD	750/60P / 750/59.94P / 750/50P / 750/30P / 750/29.97P / 750/25P / 750/24P / 750/23.98P	
GENLOCK TIMING F	±5	0
GENLOCK TIMING V	±1125	0
GENLOCK TIMING H	±432	0
GENLOCK TIMING FN	±100	0
RECOVERY MODE	AUTO / MANUAL	AUTO
AUTO SETTING	IMMEDIATE / FAST / SLOW	FAST
MANUAL SETTING	IMMEDIATE / FAST / SLOW	IMMEDIATE

#### 25.1.2 BLACK menu

Setting	Value	Factory Default Value
BLK1 NTSC	NTSC BB / NTSC BB+REF / NTSC BB+ID / NTSC BB+REF+ID / NTSC BB+SETUP / NTSC BB+S+REF / NTSC BB+S+ID / NTSC BB+S+R+ID	NTSC BB
BLK1 PAL	PAL BB / PAL BB+REF	
BLK1 COMPONENT	525/59.94I / 525/59.94P / 625/50I / 625/50P	
BLK1 1125:HD	1125/60I / 1125/59.94I / 1125/50I / 1125/30P / 1125/29.97P / 1125/25P / 1125/24P / 1125/23.98P / 1125/24PsF / 1125/23.98PsF	
BLK1 750:HD	750/60P / 750/59.94P / 750/50P / 750/30P / 750/29.97P / 750/25P / 750/24P / 750/23.98P	
BLK1 TIMING F	±5	0
BLK1 TIMING V	±1124	0
BLK1 TIMING H	±4124	0
BLK1 VITC	ON / OFF	OFF
BLK2 EQUAL TO BLK1	ON / OFF	OFF
BLK3 EQUAL TO BLK1	ON / OFF	OFF
BLK4 EQUAL TO BLK1	ON / OFF	OFF
BLK5 EQUAL TO BLK1	ON / OFF	OFF
BLK6 EQUAL TO BLK1	ON / OFF	OFF

\* BLK2, BLK3, and BLK4 to BLK6 (SER21) settings are the same as BLK1 settings.



## 25. APPENDIX

## 25.1.3 SDI menu

Setting	Value	Factory Default Value
SDI1 IMAGE	720x487:SD / 720x576:SD / 1280x720:HD / 1920x1080:HD / 1280x720:3G-A / 1920x1080:3G-A / 1920x1080:3G-B-DL / 1920x1080:HD-DL	1920x1080:HD
SDI1 STRUCTURE	422(YCbCr)10-bit / 422(YCbCr)12-bit / 444(YCbCr)10-bit / 444(YCbCr)12-bit / 444(RGB)10-bit / 444(RGB)12-bit	422(YCbCr)10-bit
SDI1 RATE	60I / 59.94I / 50I / 60P / 59.94P / 50P / 30P / 29.97P / 25P / 24P / 23.98P / 30PsF / 29.97PsF / 25PsF / 24PsF / 23.98PsF	59.94I
SDI1 0H TIMING	SERIAL / LEGACY	SERIAL
SDI1 TIMING V	±1124	0
SDI1 TIMING H	±4124	0
SDI1 COLOR BAR	100% / 75% / MULTI 100% / MULTI 75% / MULTI (+I) / SMPTE / EBU / BBC	COLOR BAR 100%
SDI1 MONITOR	FLAT FIELD 100% / FLAT FIELD 0% / RED FIELD 100% / GREEN FIELD 100% / BLUE FIELD 100%	
SDI1 SDI	CHECK FIELD	
SDI1 COMPONENT	ON / OFF	All ON
SDI1 SAFETY AREA	ON / OFF	All OFF
SCROLL	ON / OFF	OFF
SCROLL V-SPEED	±256	0
SCROLL H-SPEED	±256	0
PATTERN CHANGE	ON / OFF	OFF
PATTERN CHG SPEED	+1 to +255	+1
ID CHARACTER	ON / OFF	OFF
ID SET	◀ !"# \$%&' ( ) * +, -. / 0 1 2 3 4 5 6 7 8 9 : ; <=> ? @ A B C D E F G H I J K L M N O P Q R S T U V W X Y Z [ ¥ ] ^ _ → ←	LT4610 ◀
ID V-POSI	0 to 1079	0
ID H-POSI	0 to 1919	0
ID SIZE	x1 / x2 / x4 / x8	x1
ID LEVEL	100% / 75%	100%
ID BLINK	ON / OFF	OFF
ID BLINK ON TIME	1 to 9	1
ID BLINK OFF TIME	1 to 9	1
ID SCROLL	ON / OFF	OFF
ID SCROLL SPEED	±256	0
LOGO	ON / OFF	OFF
LOGO SELECT	INT_1 to INT_4	INT_1
LOGO V-POSI	0 to 1079	0
LOGO H-POSI	0 to 1919	0
LOGO LEVEL0	100 to EB0	100
LOGO LEVEL1	100 to EB0	590
LOGO LEVEL2	100 to EB0	A20
LOGO LEVEL3	100 to EB0	EB0
LOGO BACKGND	ON / OFF	OFF
SDI1 AUDIO ON/OFF	ON / OFF	All ON
L-* AUDIO ON/OFF	ON / OFF	All ON
G*/CH* FREQ	SILENCE / 400Hz / 800Hz / 1kHz	1kHz
L-* G*/CH* FREQ	SILENCE / 400Hz / 800Hz / 1kHz	1kHz
G*/CH* LEVEL	-60 to 0	-20
L-* G*/CH* LEVEL	-60 to 0	-20
G*/CH* CLICK	OFF / 1sec / 2sec / 4sec	OFF
L-* G*/CH* CLICK	OFF / 1sec / 2sec / 4sec	OFF
G1/CH* EQUAL CH1	ON / OFF	OFF

## 25. APPENDIX

Setting	Value	Factory Default Value
G2/CH* EQUAL CH5	ON / OFF	OFF
G3/CH* EQUAL CH9	ON / OFF	OFF
G4/CH* EQUAL CH13	ON / OFF	OFF
G* RESOLUTION	20BIT / 24BIT	20BIT
L-* G* RESOLUTION	20BIT / 24BIT	20BIT
G* EMPHASIS	50/15 / CCITT / OFF	OFF
L-* G* EMPHASIS	50/15 / CCITT / OFF	OFF
G2 EQUAL TO G1	ON / OFF	OFF
G3 EQUAL TO G1	ON / OFF	OFF
G4 EQUAL TO G3	ON / OFF	OFF
SDI1 L-B EQUAL L-A	ON / OFF	OFF
ANC ATC-LTC	ON / OFF	OFF
SDI2 EQUAL TO SDI1	ON / OFF	OFF

\* SDI2 settings are similar to the SDI1 settings.

### 25.1.4 AES/EBU menu

Setting	Value	Factory Default Value
AES/EBU	ON / OFF	ON
AES/EBU CH* FREQ	SILENCE / 400Hz / 800Hz / 1kHz	1kHz
AES/EBU CH* LEVEL	-60 to 0	-20
AES/EBU CH* CLICK	OFF / 1sec / 2sec / 4sec	OFF
CH2 EQUAL TO CH1	ON / OFF	OFF
AES/EBU RESOLUTION	20BIT / 24BIT	20BIT
AES/EBU EMPHASIS	50/15 / CCITT / OFF	OFF
AES/EBU TIMECODE	ON / OFF	OFF
AES/EBU TIMING	±511	0
SILENCE RESOLUTION	20BIT / 24BIT	20BIT
SILENCE TIMING	±511	0

### 25.1.5 WCLK Menu

Setting	Value	Factory Default Value
WCLK TIMING	±511	0

### 25.1.6 ETC Menu

Setting	Value	Factory Default Value
LIPSYNC SDI1+AES	ON / OFF	OFF
LIPSYNC SDI2	ON / OFF	OFF

25. APPENDIX

25.1.7 GPS OPTION Menu / GNSS OPTION Menu

Setting	Value	Factory Default Value
LTC	ON / OFF	OFF
FRAME	-23 to 23, -24 to 24, -29 to 29	0
BIT	-39 to 39	0
LTC2 OFFSET	±23:59:59	+00:00:00
LTC3 OFFSET	±23:59:59	+00:00:00
CW IN/OUT	INPUT / OUTPUT	INPUT
OUTPUT FREQ	CW / 1PPS	CW

25.1.8 12G OPTION menu

Setting	Value	Factory Default Value	
SDI SYSTEM	12G	3840x2160 12G / 4096x2160 12G / 7680x4320 12G(QL)-A (*1)	3840x2160 12G
	3G-A	1280x 720 3G-A / 1920x1080 3G-A / 2048x1080 3G-A	
	3G-B-DL	1920x1080 3G-B-DL / 2048x1080 3G-B-DL	
	3G-B-DS Dual	1280x 720 3G-B-DS / 1920x1080 3G-B-DS	
	3G(DL)-A	1920x1080 3G-2K-A / 2048x1080 3G-2K-A	
	3G(DL)-B-DL	1920x1080 3G-2K-B / 2048x1080 3G-2K-B	
	3G(DL)-B-DS	3840x2160 Square / 3840x2160 2Sample / 4096x2160 Square / 4096x2160 2Sample	
	3G(QL)-A	3840x2160 Square / 3840x2160 2Sample / 4096x2160 Square / 4096x2160 2Sample	
	3G(QL)-B-DL	3840x2160 Square / 3840x2160 2Sample / 4096x2160 Square / 4096x2160 2Sample	
	HD	1280x 720 HD / 1920x1080 HD	
	HD (DL)	1920x1080 HD / 2048x1080 HD	
	HD(QL)	3840x2160 Square / 4096x2160 Square	
SD	720x 487 SD / 720x 576 SD		
SDI STRUCTURE	422(YCbCr)10-bit / 422(YCbCr)12-bit / 444(YCbCr)10-bit / 444(YCbCr)12-bit / 444(RGB)10-bit / 444(RGB)12-bit	422(YCbCr)10-bit	
SDI RATE	60P / 59.94P / 50P / 48P / 47.95P / 30P / 29.97P / 25P / 24P / 23.98P / 30PsF / 29.97PsF / 25PsF / 24PsF / 23.98PsF / 60I / 59.94I / 50I	59.94P	
SDI 1 TIMING V	±1124	0	
SDI 1 TIMING H	±4124	0	
SDI1 COLOR BAR	100% / 75% / MULTI 100% / MULTI 75% / MULTI (+I) / SMPTE / EBU / BBC / ARIB STD-B66-2	COLOR BAR 100%	
SDI1 MONITOR	FLAT FIELD 100% / FLAT FIELD 0% / RED FIELD 100% / GREEN FIELD 100% / BLUE FIELD 100%		
SDI1 SDI	CHECK FIELD		
USER PATTERN 1	POWER ON LOAD   YES / NO	NO	
SDI COMPONENT	ON / OFF	All ON	
SDI SAFETY AREA	ON / OFF	All OFF	
SCROLL	ON / OFF	OFF	
SCROLL V-SPEED	±256	0	
SCROLL H-SPEED	±256	0	
PATTERN CHANGE	ON / OFF	OFF	
PATTERN CHG SPEED	+1 to +255	+1	
ID CHARACTER	ON / OFF	OFF	
ID SET	◀ !"# \$%&' () *+, -. / 0 1 2 3 4 5 6 7 8 9 : ; <=> ? @ A B C D E F G H I J K L M N O P Q R S T U V W X Y Z [ ¥ ] ^ _ → ←	LT4610 ◀	

## 25. APPENDIX

Setting	Value	Factory Default Value
ID V-POSI	0 to 4319	0
ID H-POSI	0 to 7679	0
ID SIZE	x1 / x2 / x4 / x8	x1
ID LEVEL	100% / 75%	100%
ID BLINK	ON / OFF	OFF
ID BLINK ON TIME	1 to 9	1
ID BLINK OFF TIME	1 to 9	1
ID SCROLL	ON / OFF	OFF
ID SCROLL SPEED	±256	0
LOGO	ON / OFF	OFF
LOGO SELECT	INT_1 to INT_4	INT_1
LOGO V-POSI	0 to 4319	0
LOGO H-POSI	0 to 7679	0
LOGO LEVEL0	100 to EB0	100
LOGO LEVEL1	100 to EB0	590
LOGO LEVEL2	100 to EB0	A20
LOGO LEVEL3	100 to EB0	EB0
LOGO BACKGND	ON / OFF	OFF
MOVING BOX	ON / OFF	OFF
BOX COLOR	WHITE / YELLOW / CYAN / GREEN / BLUE / RED / MAGENTA / BLACK	WHITE
MOVING BOX V-SPEED	LOW / MIDDLE / HIGH	MIDDLE
MOVING BOX H-SPEED	LOW / MIDDLE / HIGH	MIDDLE
MOVING BOX V-SIZE	SIZE1 / SIZE2 / SIZE3 / SIZE4 / SIZE5	SIZE2
MOVING BOX H-SIZE	SIZE1 / SIZE2 / SIZE3 / SIZE4 / SIZE5	SIZE2
SDI 1 LIPSYNC	ON / OFF	OFF
SDI USER PAYLOAD	ON / OFF	OFF
SDI AUDIO ON/OFF	ON / OFF	All ON
L-* AUDIO ON/OFF	ON / OFF	All ON
G* RESOLUTION	20BIT / 24BIT	20BIT
L-* G* RESOLUTION	20BIT / 24BIT	20BIT
G* EMPHASIS	50/15 / CCITT / OFF	OFF
L-* G* EMPHASIS	50/15 / CCITT / OFF	OFF
G*/CH* FREQ	SILENCE / 400Hz / 800Hz / 1kHz	1kHz
L-* G*/CH* FREQ	SILENCE / 400Hz / 800Hz / 1kHz	1kHz
G*/CH* LEVEL	-60 to 0	-20
G*/CH* CLICK	OFF / 1sec / 2sec / 4sec	OFF
L-* G*/CH* CLICK	OFF / 1sec / 2sec / 4sec	OFF
L-* G*/CH* LEVEL	-60 to 0	-20
SDI L-B EQUAL L-A	ON / OFF	OFF
G2 EQUAL TO G1	ON / OFF	OFF
G3 EQUAL TO G1	ON / OFF	OFF
G4 EQUAL TO G3	ON / OFF	OFF
G1/CH* EQUAL CH1	ON / OFF	OFF
G2/CH* EQUAL CH5	ON / OFF	OFF
G3/CH* EQUAL CH9	ON / OFF	OFF
G4/CH* EQUAL CH13	ON / OFF	OFF
12G EQUAL TO SDI 1	ON / OFF	OFF
12G EQUAL TO SDI 3	ON / OFF	OFF

\* SDI2 to SDI4 settings are similar to the SDI1 settings.

\*1 7680x4320 12G(QL)-A is displayed when SER24 is installed.

25. APPENDIX

25.1.9 PTP OPTION Menu

- PTP master

Setting	Value		Factory Default Value
MODE	ENABLE MASTER / DISABLE MASTER		PTP1:ENABLE MASTER PTP2:DISABLE MASTER
PROFILE TYPE	ST2059 / AES67 / GENERAL		ST2059
PROFILE SET DEFAULT	ENTER TO DEFAULT		ENTER TO DEFAULT
DOMAIN	ST2059	0 to 127	PTP1:127 PTP2:126
	AES67	0 to 255	PTP1:0 PTP2:0
	GENERAL	0 to 255	PTP1:0 PTP2:0
COMMUNICATION MODE	MIXED SMPTE / MIXED SMPTE w/o NE / UNICAST / MULTICAST		MIXED SMPTE w/o NE
ANNOUNCE INTERVAL	ST2059	0.125s 8Hz / 0.25s 4Hz / 0.5s 2Hz / 1s 1Hz / 2s 0.5Hz	0.25s 4Hz
	AES67	1s 1Hz / 2s 0.5Hz / 4s 0.25Hz / 8s 0.125Hz / 16s 0.0625Hz	2s 0.5Hz
	GENERAL	0.125s 8Hz / 0.25s 4Hz / 0.5s 2Hz / 1s 1Hz / 2s 0.5Hz / 4s 0.25Hz / 8s 0.125Hz / 16s 0.0625Hz	2s 0.5Hz
SYNC INTERVAL	ST2059	0.0078s 128Hz / 0.015s 64Hz / 0.0312s 32Hz / 0.0625s 16Hz / 0.125s 8Hz / 0.25s 4Hz / 0.5s 2Hz	0.125s 8Hz
	AES67	0.0625s 16Hz / 0.125s 8Hz / 0.25s 4Hz / 0.5s 2Hz / 1s 1Hz	0.125s 8Hz
	GENERAL	0.125s 8Hz / 0.25s 4Hz / 0.5s 2Hz / 1s 1Hz / 2s 0.5Hz / 4s 0.25Hz / 8s 0.125Hz / 16s 0.0625Hz	1s 1Hz
PRIORITY1	0 to 255		128
PRIORITY2	0 to 255		128
STEP	ONE STEP / TWO STEP		ONE STEP
DEFAULT FRAME	23.98 / 24 / 25 / 29.97 / 30 / 47.95 / 48 / 50 / 59.94 / 60 / 71.92 / 72 / 100 / 119.9 / 120		29.97
DROP FRAME FLAG	ENABLE / DISABLE		ENABLE
COLOR FRAME ID	ENABLE / DISABLE		ENABLE
DELAY MECHANISM	END TO END / PEER TO PEER		END TO END

25. APPENDIX

- PTP slave

Setting	Value		Factory Default Value
MODE	PTP1:SLAVE PTP2: ENABLE MASTER / DISABLE MASTER		PTP1:SLAVE PTP2:DISABLE MASTER
PROFILE TYPE	ST2059 / AES67 / GENERAL		ST2059
PROFILE SET DEFAULT	ENTER TO DEFAULT		ENTER TO DEFAULT
DOMAIN	ST2059	0 to 127	PTP1:127 PTP2:126
	AES67	0 to 255	PTP1:0 PTP2:0
	GENERAL	0 to 255	PTP1:0 PTP2:0
COMMUNICATION MODE	MIXED SMPTE / MIXED SMPTE w/o NE / UNICAST / MULTICAST		MULTICAST
ANNOUNCE DESIR INT (UNICAST)	ST2059	0.125s 8Hz / 0.25s 4Hz / 0.5s 2Hz / 1s 1Hz / 2s 0.5Hz	0.25s 4Hz
	AES67	1s 1Hz / 2s 0.5Hz / 4s 0.25Hz / 8s 0.125Hz / 16s 0.0625Hz	2s 0.5Hz
	GENERAL	0.125s 8Hz / 0.25s 4Hz / 0.5s 2Hz / 1s 1Hz / 2s 0.5Hz / 4s 0.25Hz / 8s 0.125Hz / 16s 0.0625Hz	2s 0.5Hz
ANNOUNCE REQD INT (UNICAST)	ST2059	0.125s 8Hz / 0.25s 4Hz / 0.5s 2Hz / 1s 1Hz / 2s 0.5Hz	2s 0.5Hz
	AES67	1s 1Hz / 2s 0.5Hz / 4s 0.25Hz / 8s 0.125Hz / 16s 0.0625Hz	16s 0.0625Hz
	GENERAL	0.125s 8Hz / 0.25s 4Hz / 0.5s 2Hz / 1s 1Hz / 2s 0.5Hz / 4s 0.25Hz / 8s 0.125Hz / 16s 0.0625Hz	16s 0.0625Hz
SYNC DESIR INT (UNICAST)	ST2059	0.0078s 128Hz / 0.015s 64Hz / 0.0312s 32Hz / 0.0625s 16Hz / 0.125s 8Hz / 0.25s 4Hz / 0.5s 2Hz	0.125s 8Hz
	AES67	0.0625s 16Hz / 0.125s 8Hz / 0.25s 4Hz / 0.5s 2Hz / 1s 1Hz / 2s 0.5Hz	1s 1Hz
	GENERAL	0.0078s 128Hz / 0.015s 64Hz / 0.0312s 32Hz / 0.0625s 16Hz / 0.125s 8Hz / 0.25s 4Hz / 0.5s 2Hz / 1s 1Hz / 2s 0.5Hz / 4s 0.25Hz / 8s 0.125Hz	2s 0.5Hz
SYNC REQD INT (UNICAST)	ST2059	0.0078s 128Hz / 0.015s 64Hz / 0.0312s 32Hz / 0.0625s 16Hz / 0.125s 8Hz / 0.25s 4Hz / 0.5s 2Hz	0.5s 2Hz
	AES67	0.0625s 16Hz / 0.125s 8Hz / 0.25s 4Hz / 0.5s 2Hz / 1s 1Hz / 2s 0.5Hz	2s 0.5Hz
	GENERAL	0.0078s 128Hz / 0.015s 64Hz / 0.0312s 32Hz / 0.0625s 16Hz / 0.125s 8Hz / 0.25s 4Hz / 0.5s 2Hz / 1s 1Hz / 2s 0.5Hz / 4s 0.25Hz / 8s 0.125Hz	8s 0.125Hz
DELAY MSG INTERVAL (MULTICAST, MIXED SMPTE w/o NEGTIATION)	ST2059	0.0078s 128Hz / 0.015s 64Hz / 0.0312s 32Hz / 0.0625s 16Hz / 0.125s 8Hz / 0.25s 4Hz / 0.5s 2Hz	0.125s 8Hz
	AES67	0.125s 8Hz / 0.25s 4Hz / 0.5s 2Hz / 1s 1Hz / 2s 0.5Hz / 4s 0.25Hz / 8s 0.125Hz / 16s 0.0625Hz	1s 1Hz
	GENERAL	0.0078s 128Hz / 0.015s 64Hz / 0.0312s 32Hz / 0.0625s 16Hz / 0.125s 8Hz / 0.25s 4Hz / 0.5s 2Hz / 1s 1Hz / 2s 0.5Hz / 4s 0.25Hz / 8s 0.125Hz / 16s 0.0625Hz	1s 1Hz
DLY MSG DESIRED INT (UNICAST, MIXED SMPTE)	ST2059	0.0078s 128Hz / 0.015s 64Hz / 0.0312s 32Hz / 0.0625s 16Hz / 0.125s 8Hz / 0.25s 4Hz / 0.5s 2Hz	0.125s 8Hz
	AES67	0.125s 8Hz / 0.25s 4Hz / 0.5s 2Hz / 1s 1Hz / 2s 0.5Hz / 4s 0.25Hz / 8s 0.125Hz / 16s 0.0625Hz	0.125s 8Hz
	GENERAL	0.0078s 128Hz / 0.015s 64Hz / 0.0312s 32Hz / 0.0625s 16Hz / 0.125s 8Hz / 0.25s 4Hz / 0.5s 2Hz / 1s 1Hz / 2s 0.5Hz / 4s 0.25Hz / 8s 0.125Hz / 16s 0.0625Hz	2s 0.5Hz
DLY MSG REQD INT (UNICAST, MIXED SMPTE)	ST2059	0.0078s 128Hz / 0.015s 64Hz / 0.0312s 32Hz / 0.0625s 16Hz / 0.125s 8Hz / 0.25s 4Hz / 0.5s 2Hz	0.5s 2Hz
	AES67	0.125s 8Hz / 0.25s 4Hz / 0.5s 2Hz / 1s 1Hz / 2s 0.5Hz /	2s 0.5Hz

25. APPENDIX

Setting	Value		Factory Default Value
		4s 0.25Hz / 8s 0.125Hz / 16s 0.0625Hz	
	GENERAL	0.0078s 128Hz / 0.015s 64Hz / 0.0312s 32Hz / 0.0625s 16Hz / 0.125s 8Hz / 0.25s 4Hz / 0.5s 2Hz / 1s 1Hz / 2s 0.5Hz / 4s 0.25Hz / 8s 0.125Hz / 16s 0.0625Hz	8s 0.125Hz
ANNOUNCE TIMEOUT	2 to 10		3
DELAY MECHANISM	END TO END / PEER TO PEER		END TO END
AMT CONFIGURATION	000.000.000.000 to 255.255.255.255		000.000.000.000
ASSYMMETRIC DELAY	-20.000 to 20.000 usec		00.000 usec

## 25. APPENDIX

## 25.1.10 SYSTEM Menu

Setting	Value	Factory Default Value
LCD BACKLIGHT	ON / AUTO OFF / OFF	ON
KEY LOCK	ON / OFF	OFF
POWER ON RECALL	OFF / NUMBER 0 to NUMBER 9	OFF
IP ADDRESS	000.000.000.000 to 255.255.255.255	192.168.000.001
SUBNET MASK	000.000.000.000 to 255.255.255.255	255.255.255.000
DEFAULT GATEWAY	000.000.000.000 to 255.255.255.255	000.000.000.000
SNMP TRAP	ON / OFF	OFF
SNMP MANAGER IP	000.000.000.000 to 255.255.255.255	000.000.000.000
READ COMMUNITY	▲ 0123456789	LDRUser▲
WRITE COMMUNITY	ABCDEFGHIJKLMNopqrstuvwxyz	LDRAdm▲
TRAP COMMUNITY	abcdefghijklmnopqrstuvwxyz	LDRUser▲
PTP IP ADDRESS	000.000.000.000 to 255.255.255.255	192.168.000.001
PTP SUBNET MASK	000.000.000.000 to 255.255.255.255	255.255.255.000
PTP GATEWAY	000.000.000.000 to 255.255.255.255	000.000.000.000
PTP SFP/SFP+	SFP / SFP+	SFP+
PTP PORT RELATION	FULLY CROSS-LINK / ISOLATED / MIRROR RJ45 TO SFP	ISOLATED
DATE&TIME SOURCE	INTERNAL / GPS / GNSS / PTP	INTERNAL
DATE&TIME ADJUST	2000/01/01 00:00:00 to 2099/12/31 23:59:59	Current time
TIMECODE SOURCE	GPS / GNSS / INTERNAL / LTC0 / VITC / SMPTE ST309 / PTP	INTERNAL
DROP FRAME	ON / OFF	ON
JAM SYNC	ON / OFF	ON
JAM SYNC ADJUST	00:00:00 to 23:59:59	00:00:00
DAYLIGHT SAVING	ON / OFF	OFF
CHANGE DAY	01/01 00:00:00 to 12/31 23:59:00	01/01 00:00:00
TIMECODE OFFSET	±23:59:59	+00:00:00
RETURN DAY	01/01 00:00:00 to 12/31 23:59:00	01/01 00:00:00
SCHEDULED TIME	00:00:00 to 11:59:00 PM	00:00:00
TIMEZONE OFFSET	UTC-12:00 to UTC+12:00	UTC+09:00
ANTENNA POWER	OFF / 3.3V / 5V	OFF
PLATFORM MODE	STATIONARY / AUTOMOTIVE	STATIONARY
EPOCH	SMPTE / TAI	SMPTE
ALARM POLARITY	POSITIVE / NEGATIVE	POSITIVE
POWER1	ENABLE / DISABLE	ENABLE
POWER2	ENABLE / DISABLE	ENABLE
FAN	ENABLE / DISABLE	ENABLE
GENLOCK NO SIGNAL	ENABLE / DISABLE	ENABLE
GENLOCK ST IN SYNC	ENABLE / DISABLE	ENABLE
GPS ANNTENA	ENABLE / DISABLE	ENABLE
GPS PLL	ENABLE / DISABLE	ENABLE
GPS SIGNAL	ENABLE / DISABLE	ENABLE
CW SIGNAL	ENABLE / DISABLE	ENABLE
LTC0 SIGNAL	ENABLE / DISABLE	ENABLE
VITC SIGNAL	ENABLE / DISABLE	ENABLE
PTP1 PORT AT AUS	ENABLE / DISABLE	ENABLE
PTP2 PORT AT AUS	ENABLE / DISABLE	ENABLE
PTP1 LOCK	ENABLE / DISABLE	ENABLE
PTP2 LOCK	ENABLE / DISABLE	ENABLE
ATTENTION	ENABLE / DISABLE	ENABLE
WEB BROWSER	ON / OFF	OFF
FORMAT SETTING	NTSC / PAL	NTSC



## 25.2 Menu Tree

Menus may not be displayed depending on other settings or options. For details, see the LT 4610 / LT 4611 instruction manual.

### 25.2.1 STATUS Menu

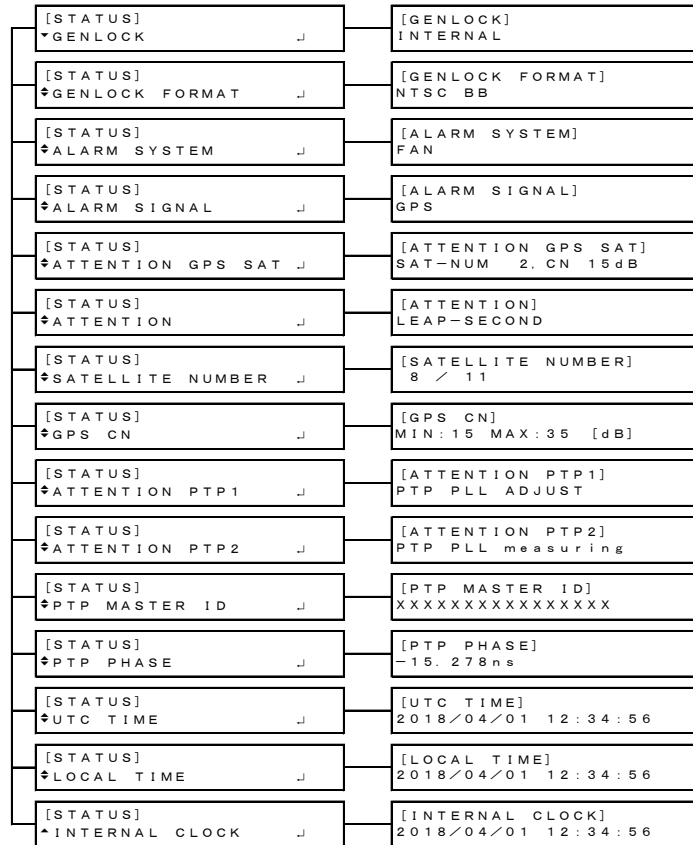

25.2.2 INFO Menu

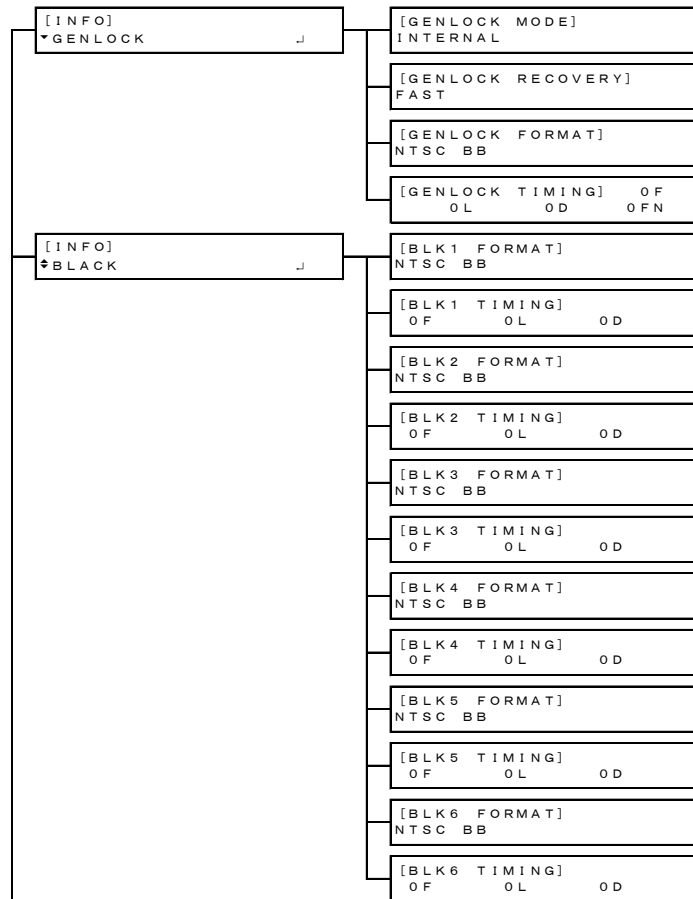

25. APPENDIX

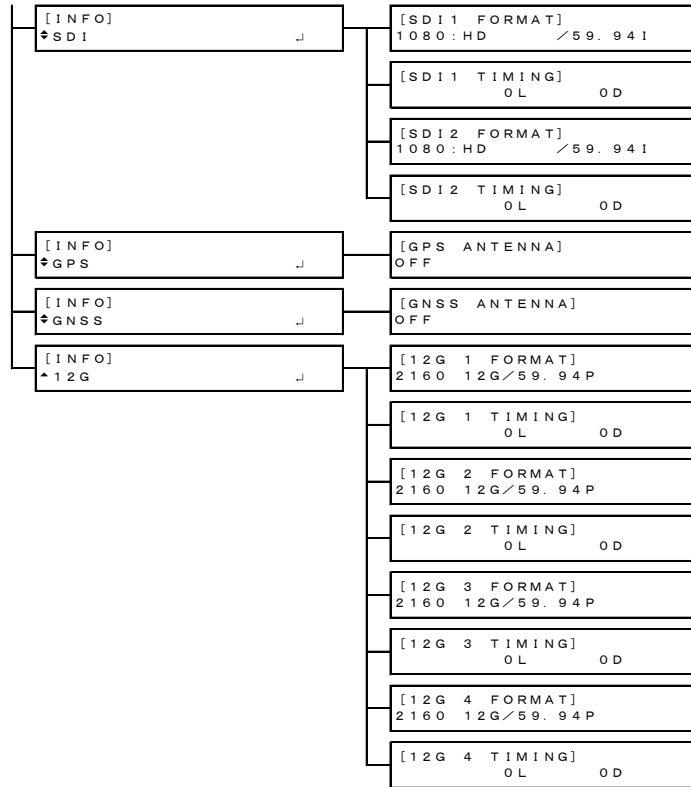

25.2.3 GENLOCK Menu

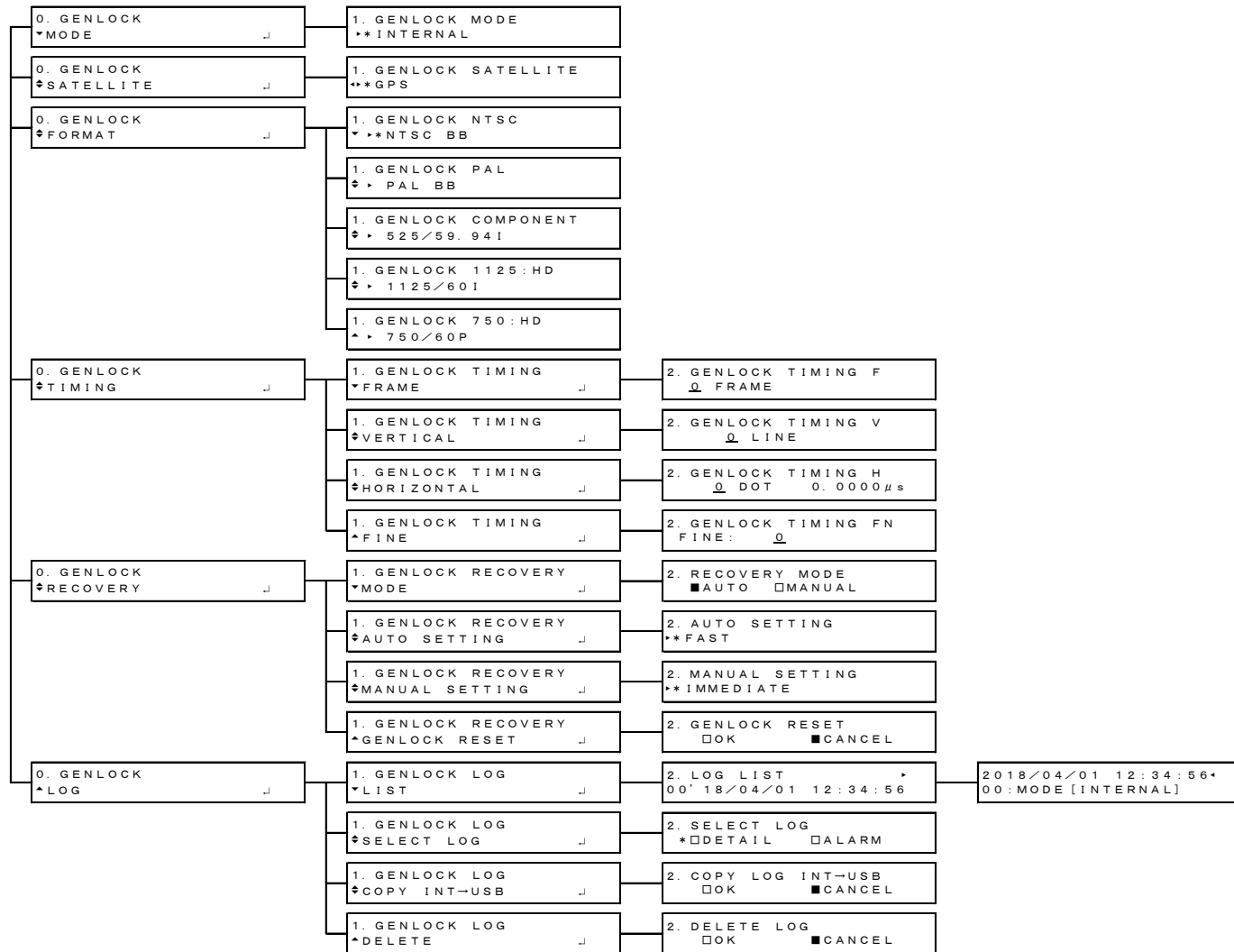

25. APPENDIX

25.2.4 BLACK Menu

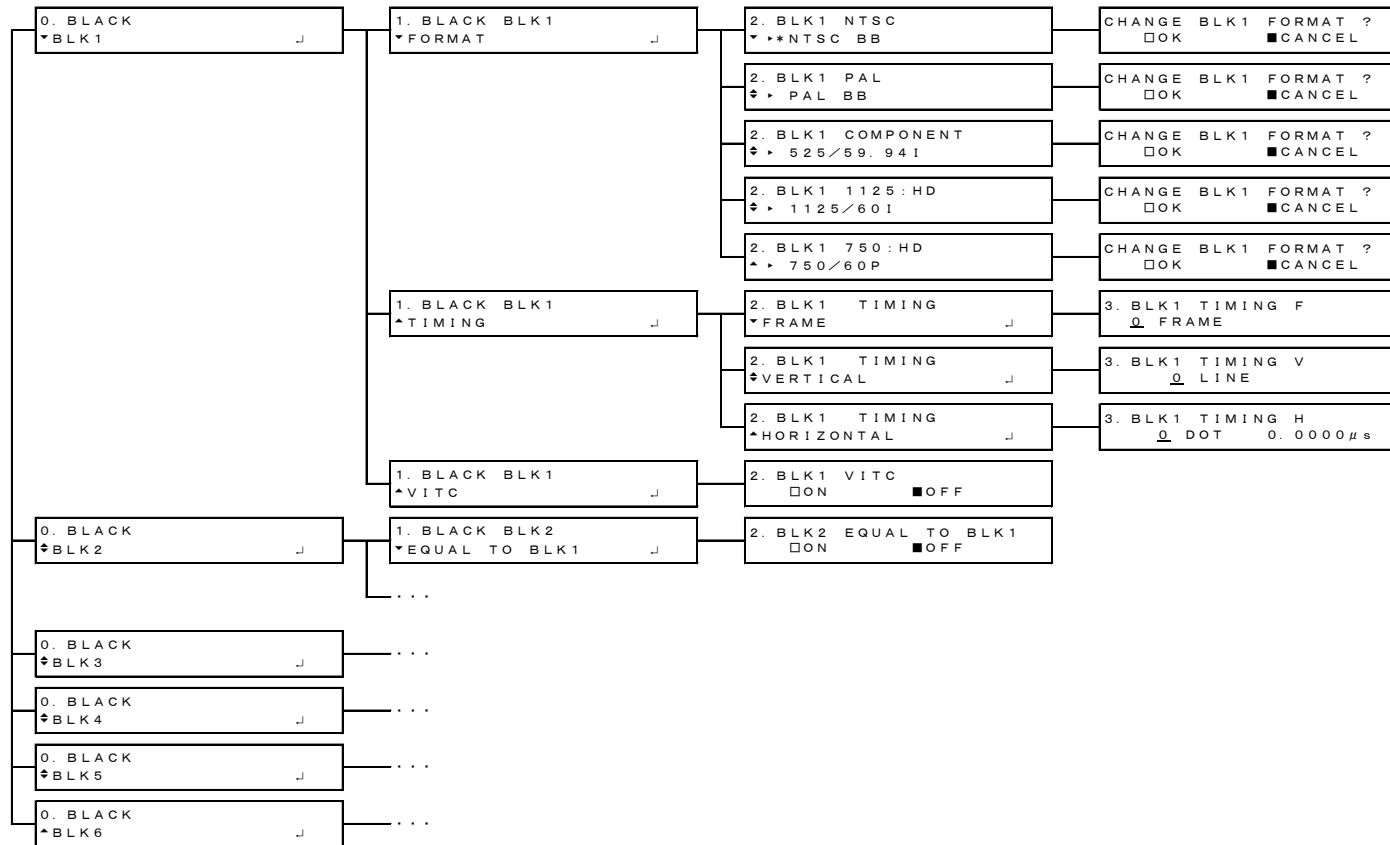

## 25. APPENDIX

### 25.2.5 SDI Menu

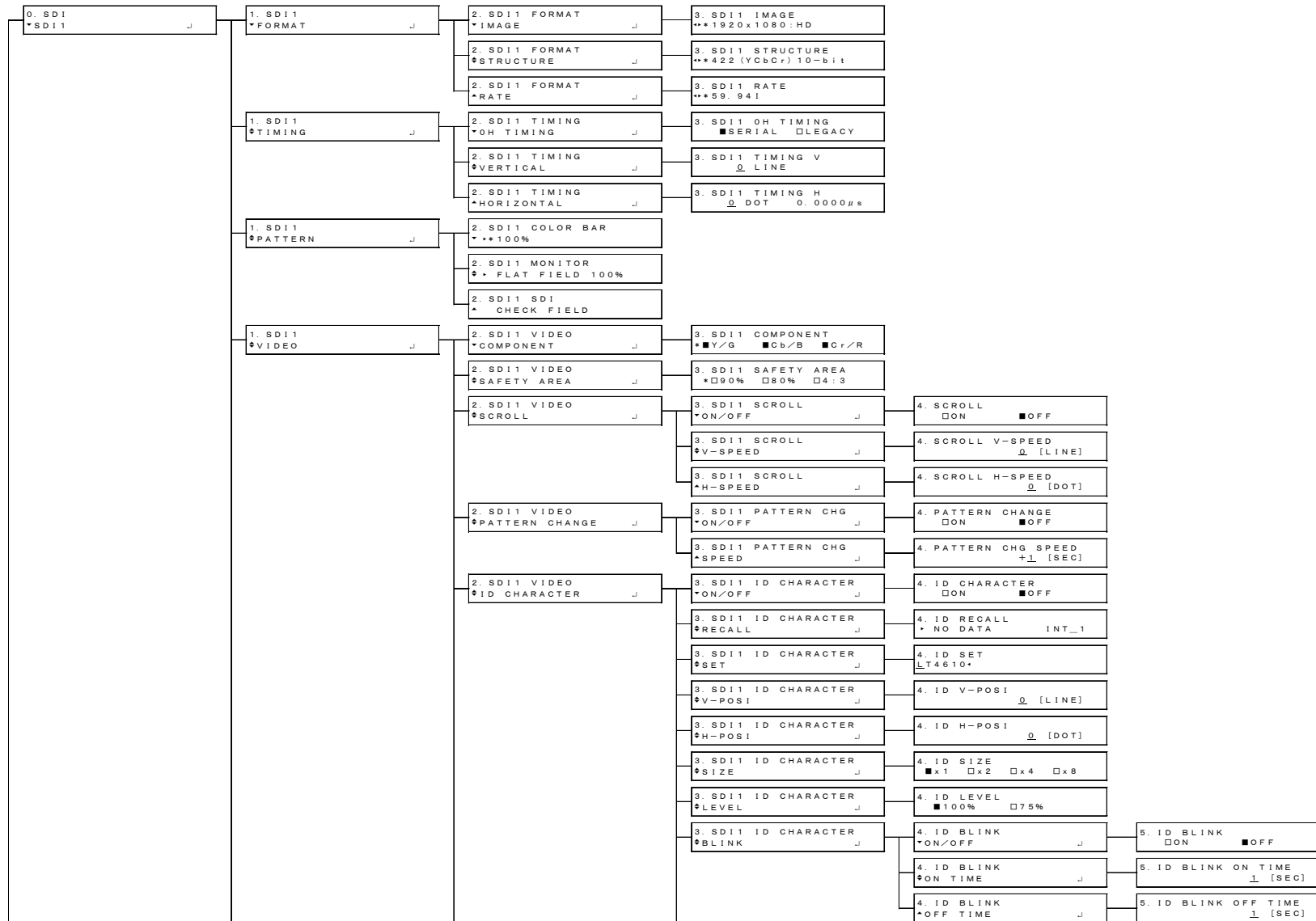

## 25. APPENDIX

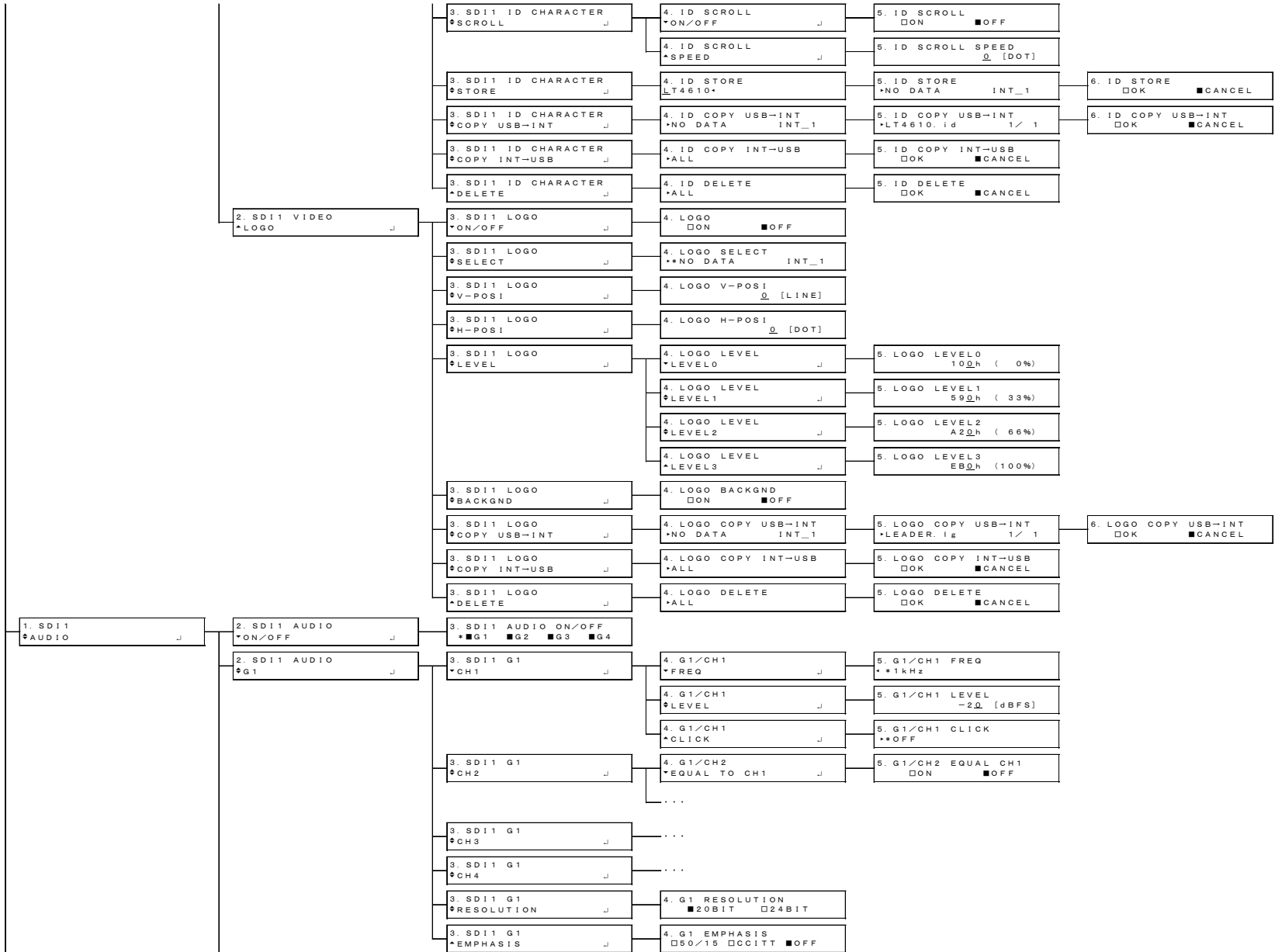

## 25. APPENDIX

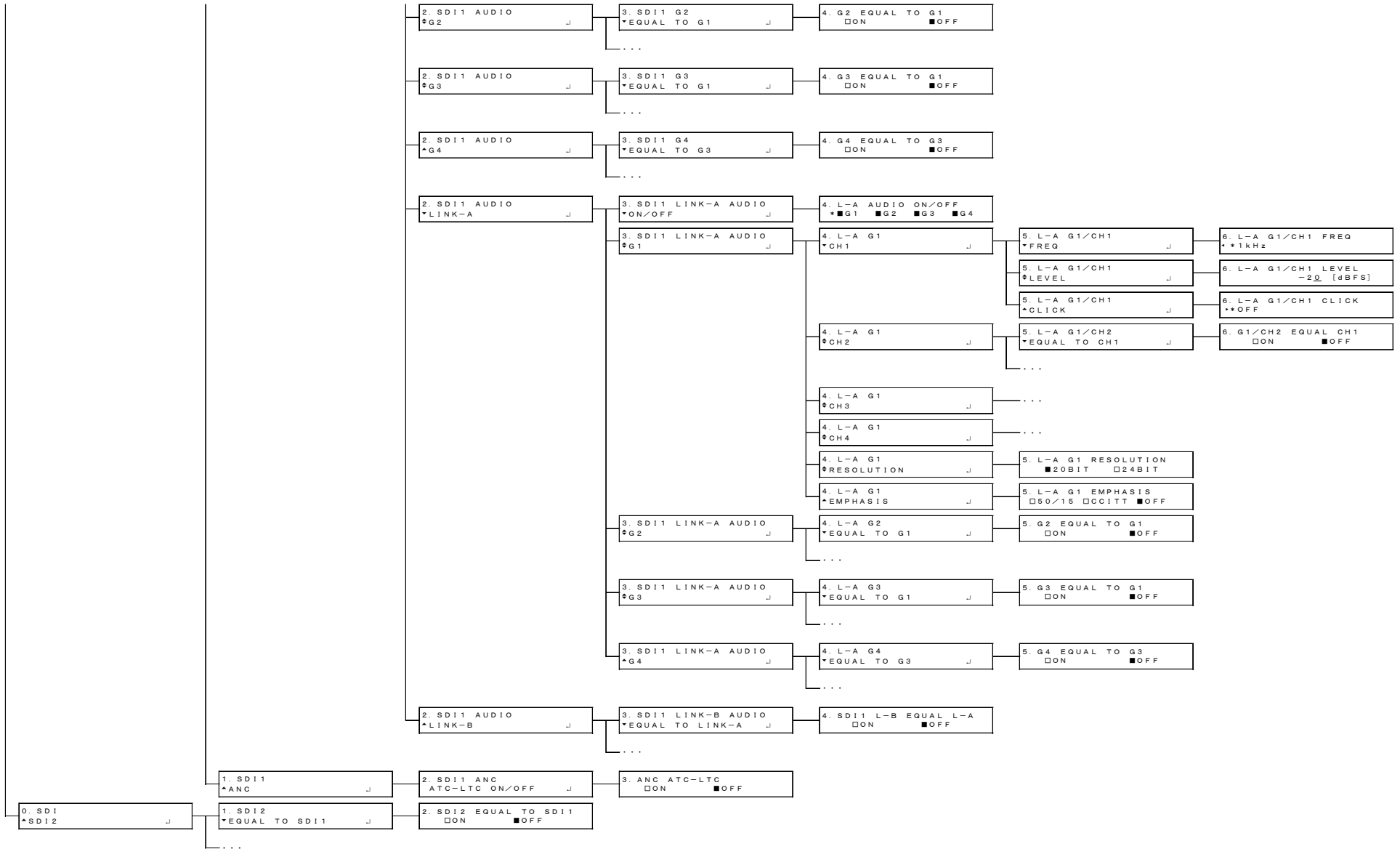



## 25. APPENDIX

### 25.2.6 AES/EBU Menu

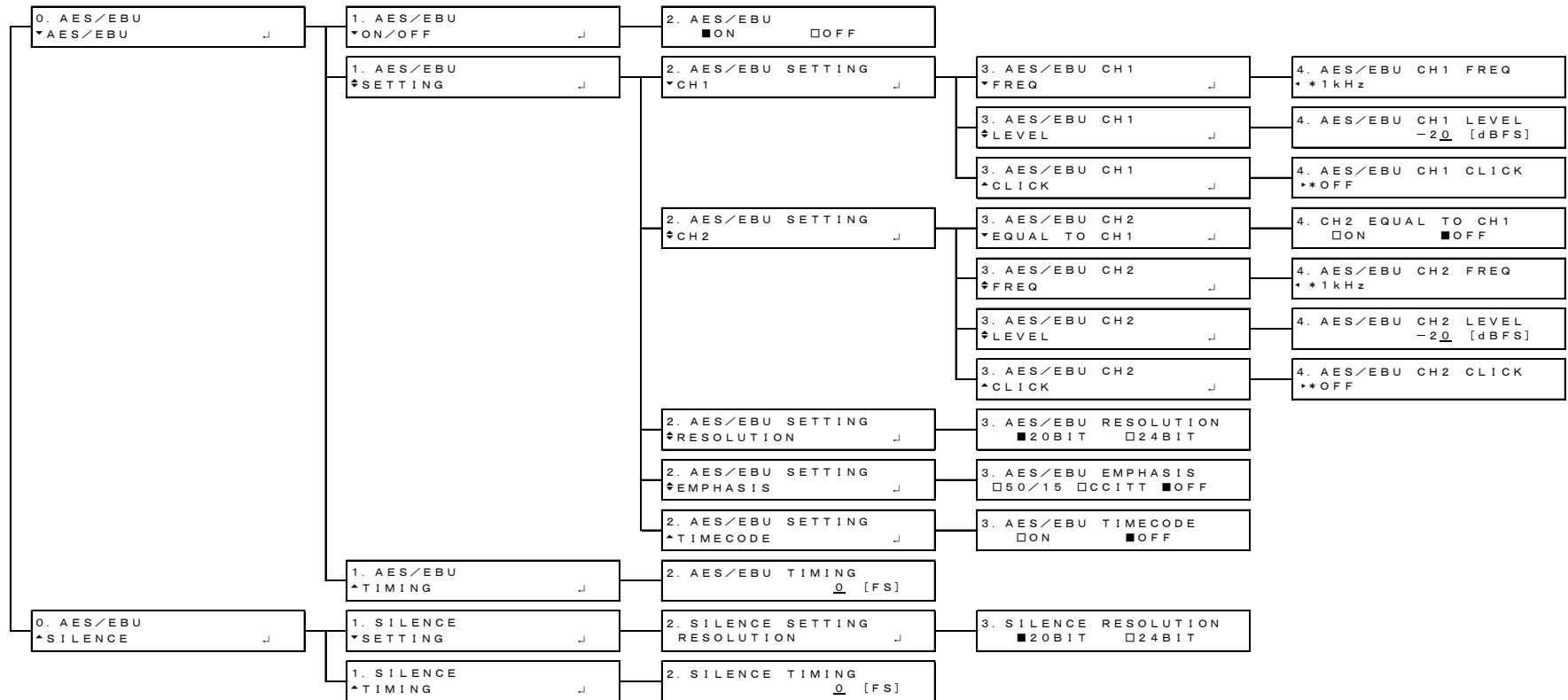

### 25.2.7 WCLK Menu



### 25.2.8 ETC Menu

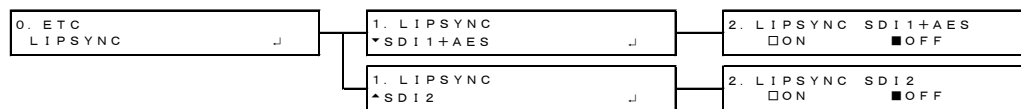

## 25. APPENDIX

### 25.2.9 GPS OPTION Menu

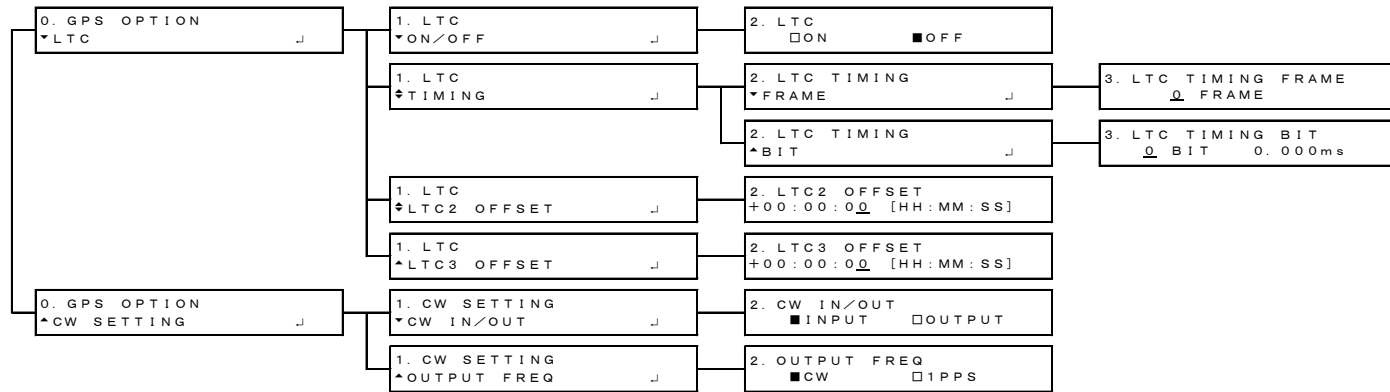

25.2.10 GNSS OPTION Menu

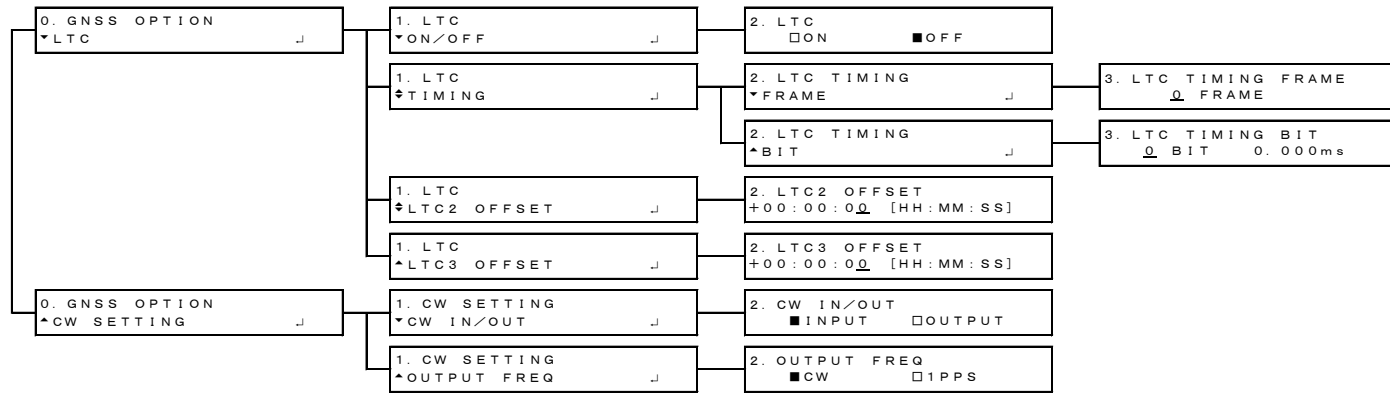

25. APPENDIX

25.2.11 12G OPTION Menu



LT

## 25. APPENDIX

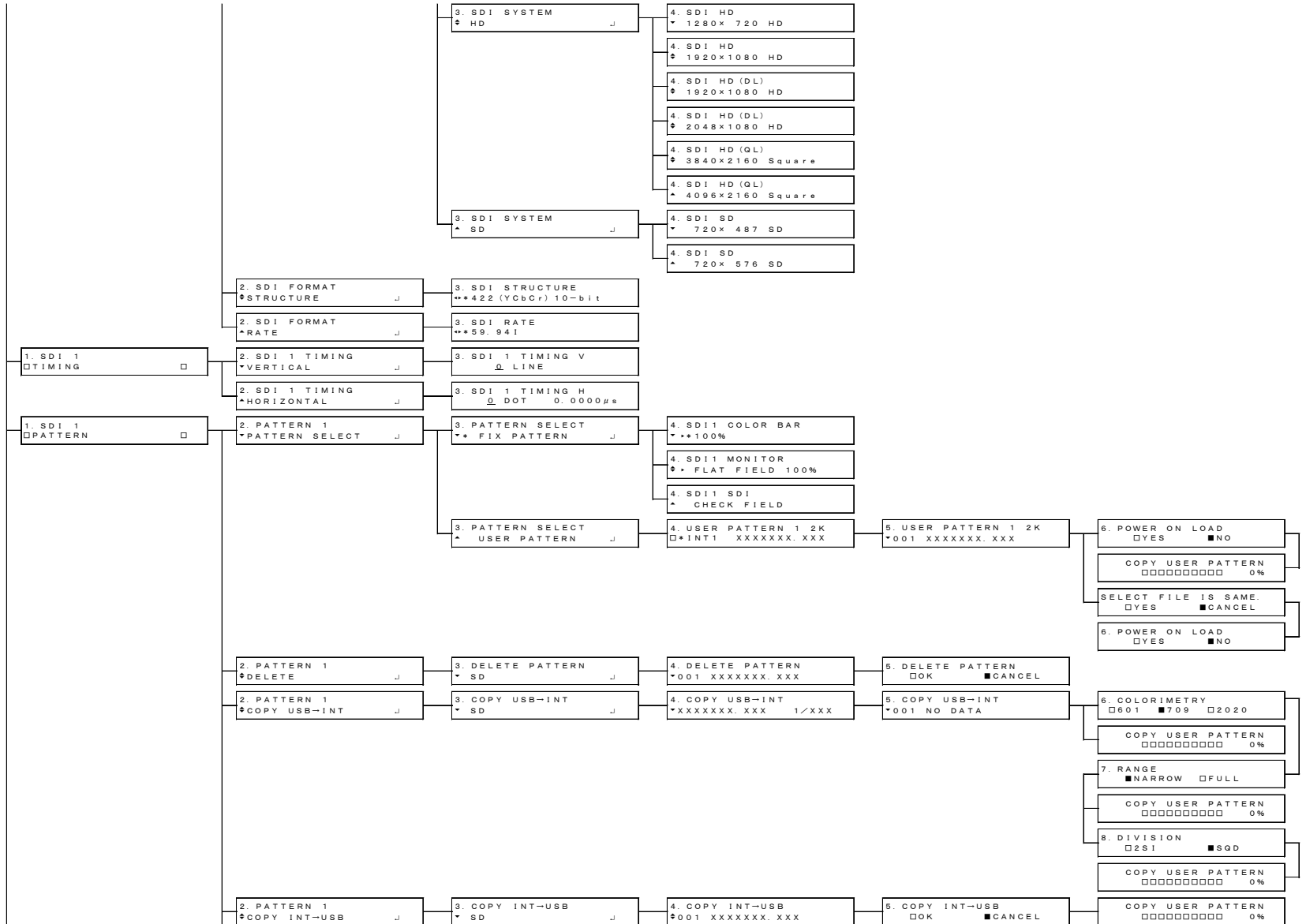

## 25. APPENDIX

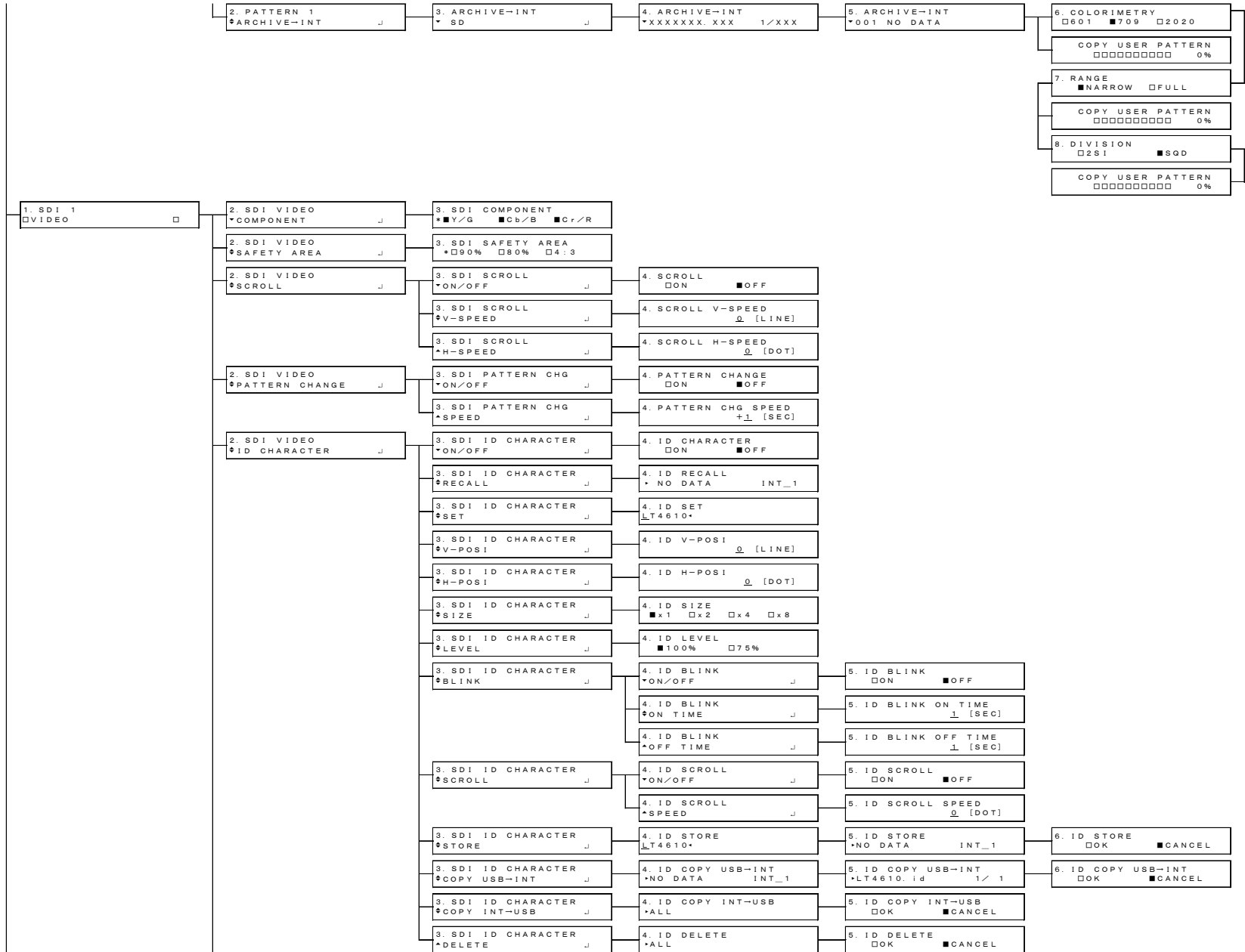

## 25. APPENDIX

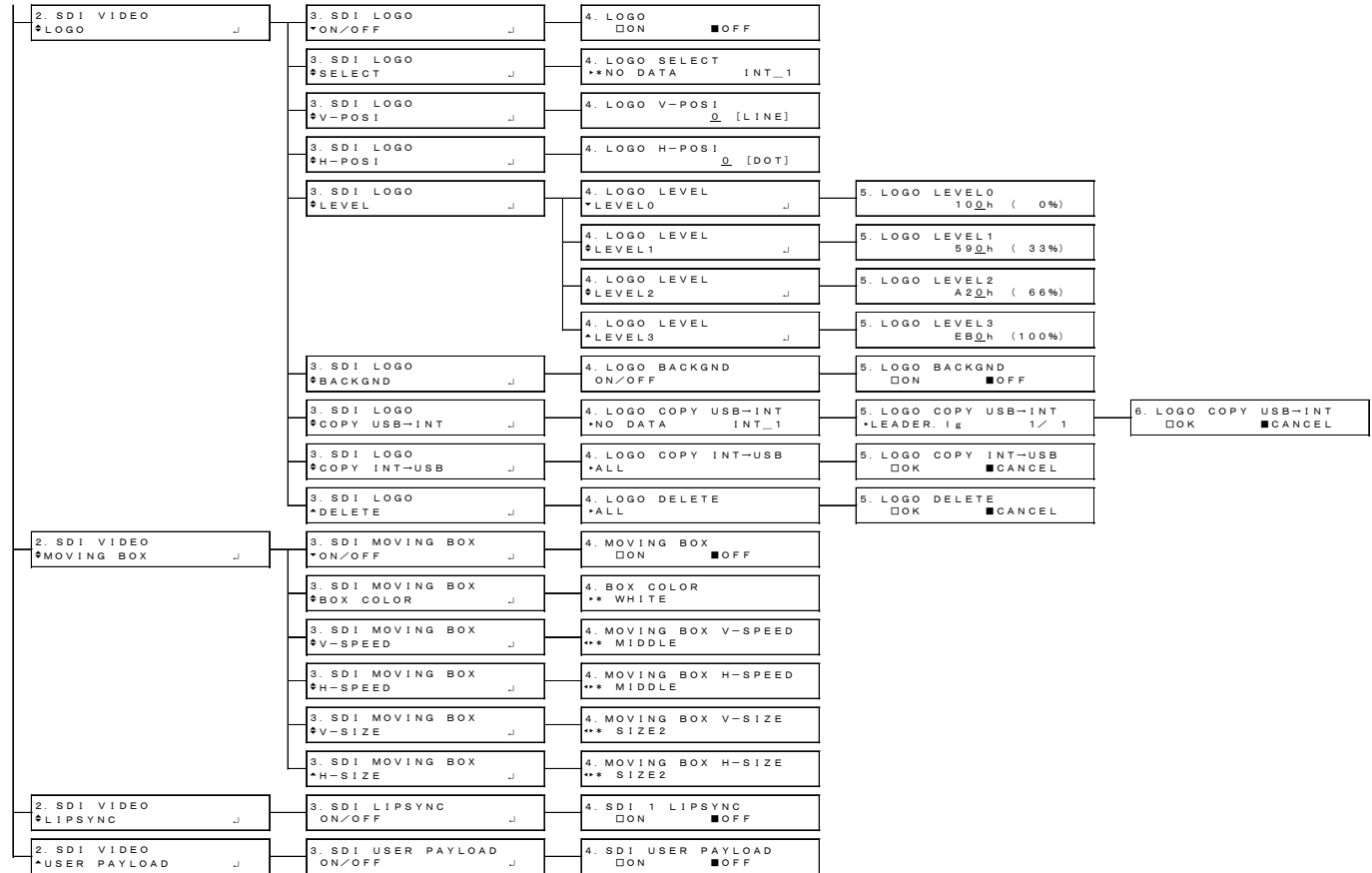

## 25. APPENDIX

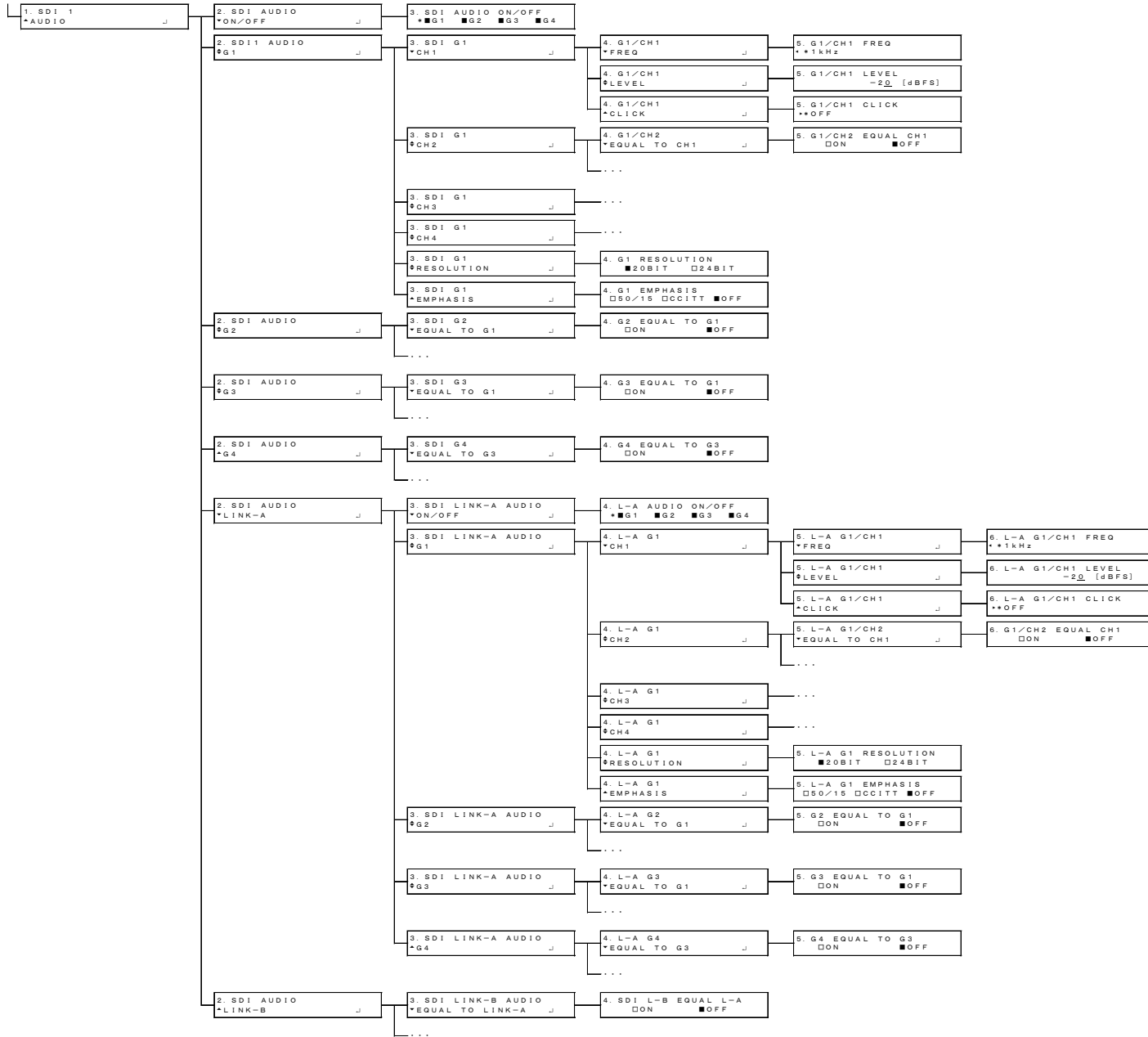



## 25. APPENDIX



25. APPENDIX

25.2.12 PTP OPTION Menu

• PTP master

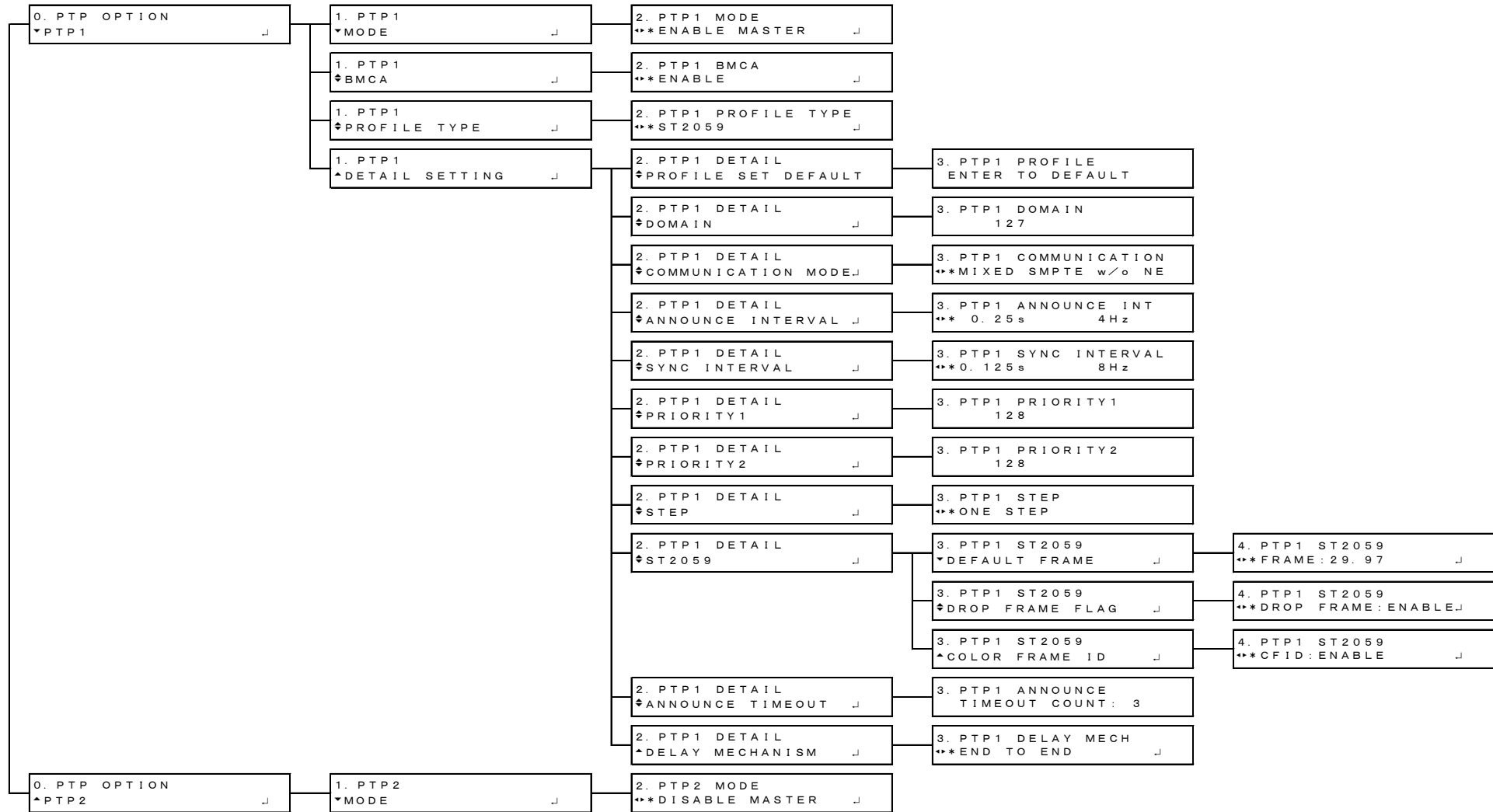

## 25. APPENDIX

### • PTP slave (MIXED SMPTE)

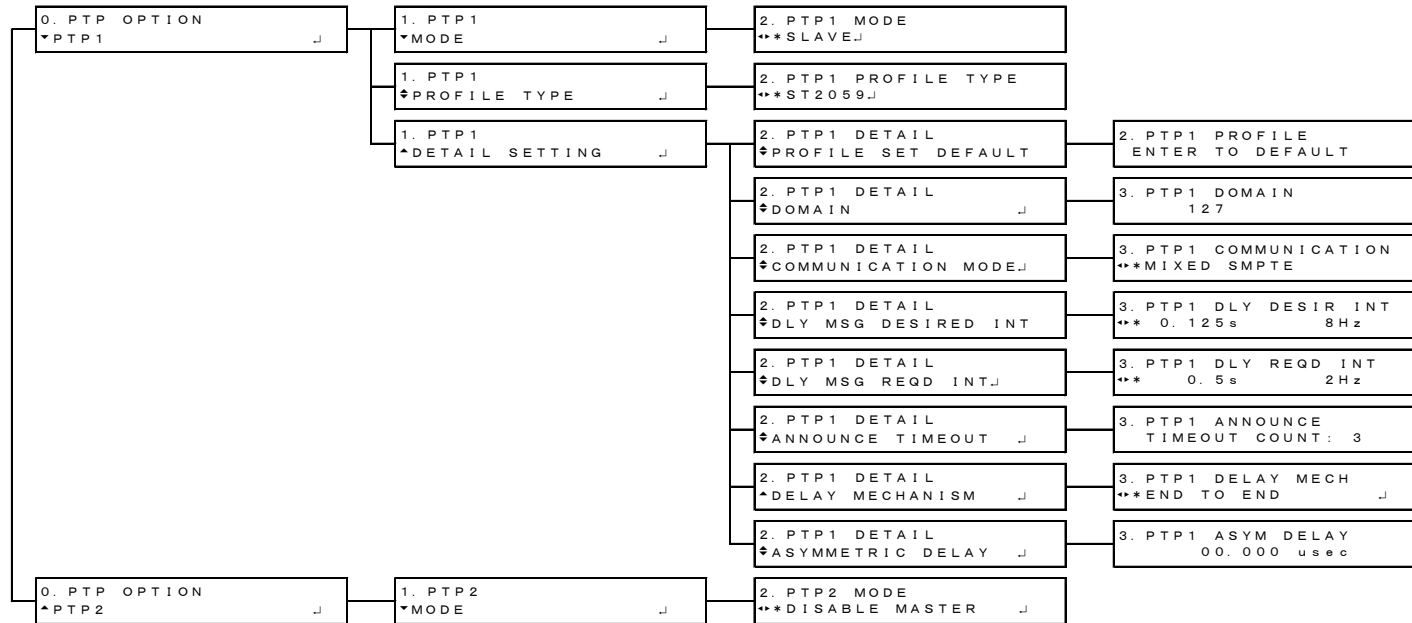

## 25. APPENDIX

### • PTP slave (MIXED SMPTE WITHOUT NEGOTIATION)

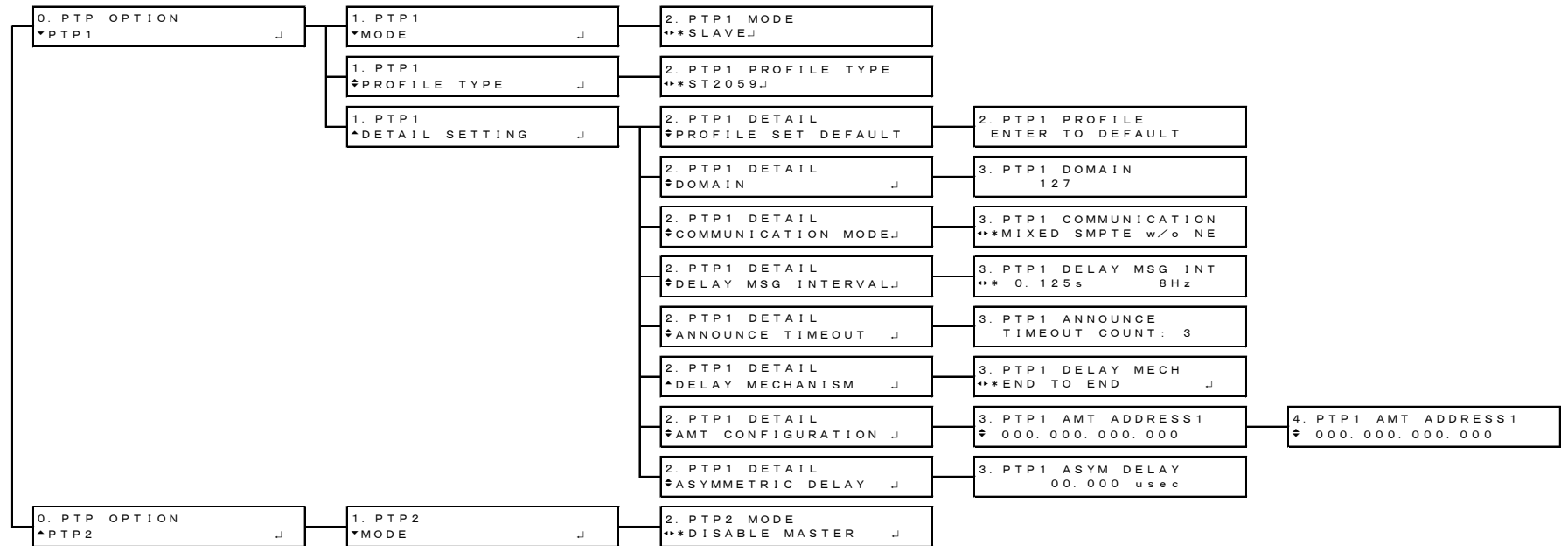

## 25. APPENDIX

### • PTP slave (UNICAST)

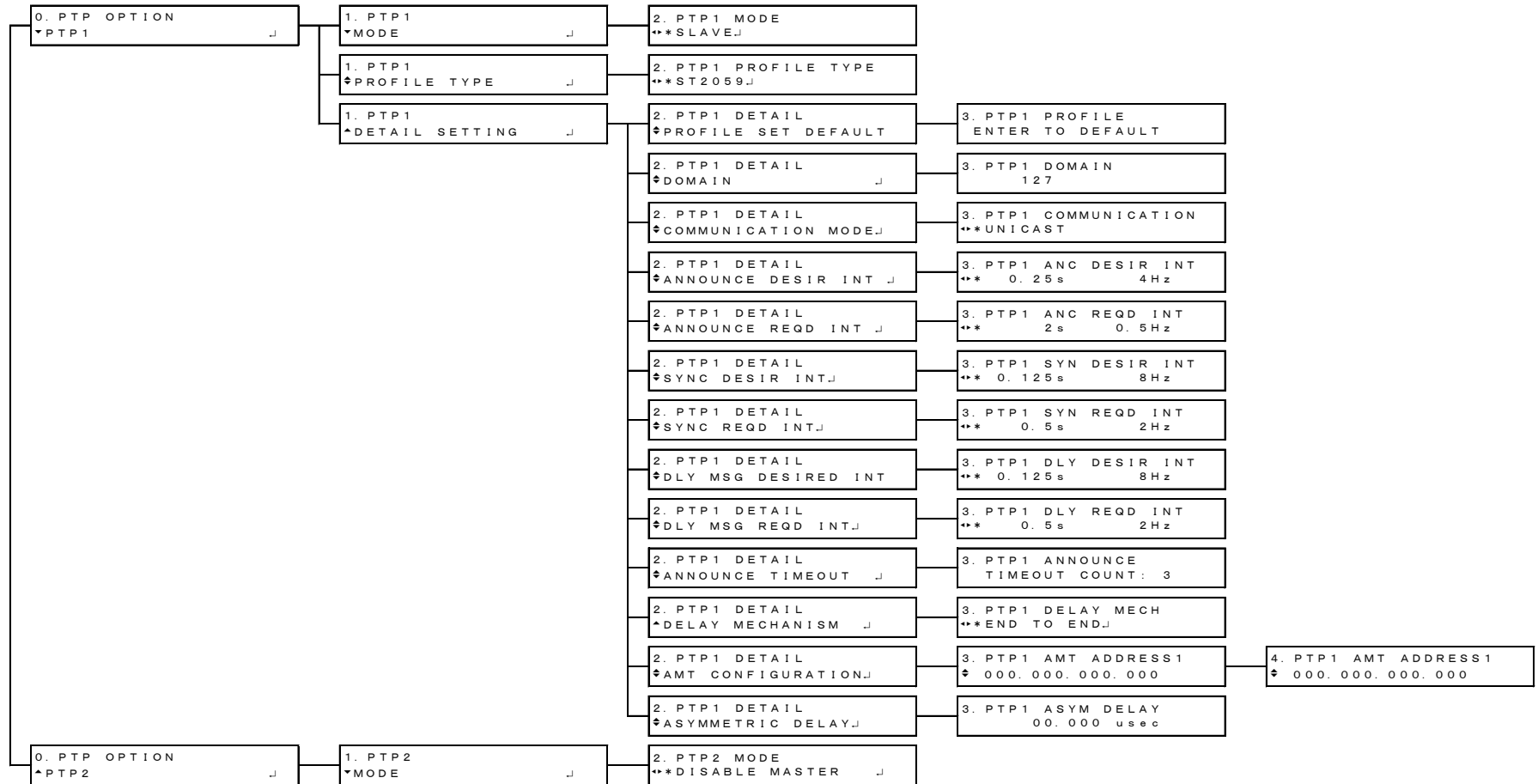

## 25. APPENDIX

### • PTP slave (MULTICAST)

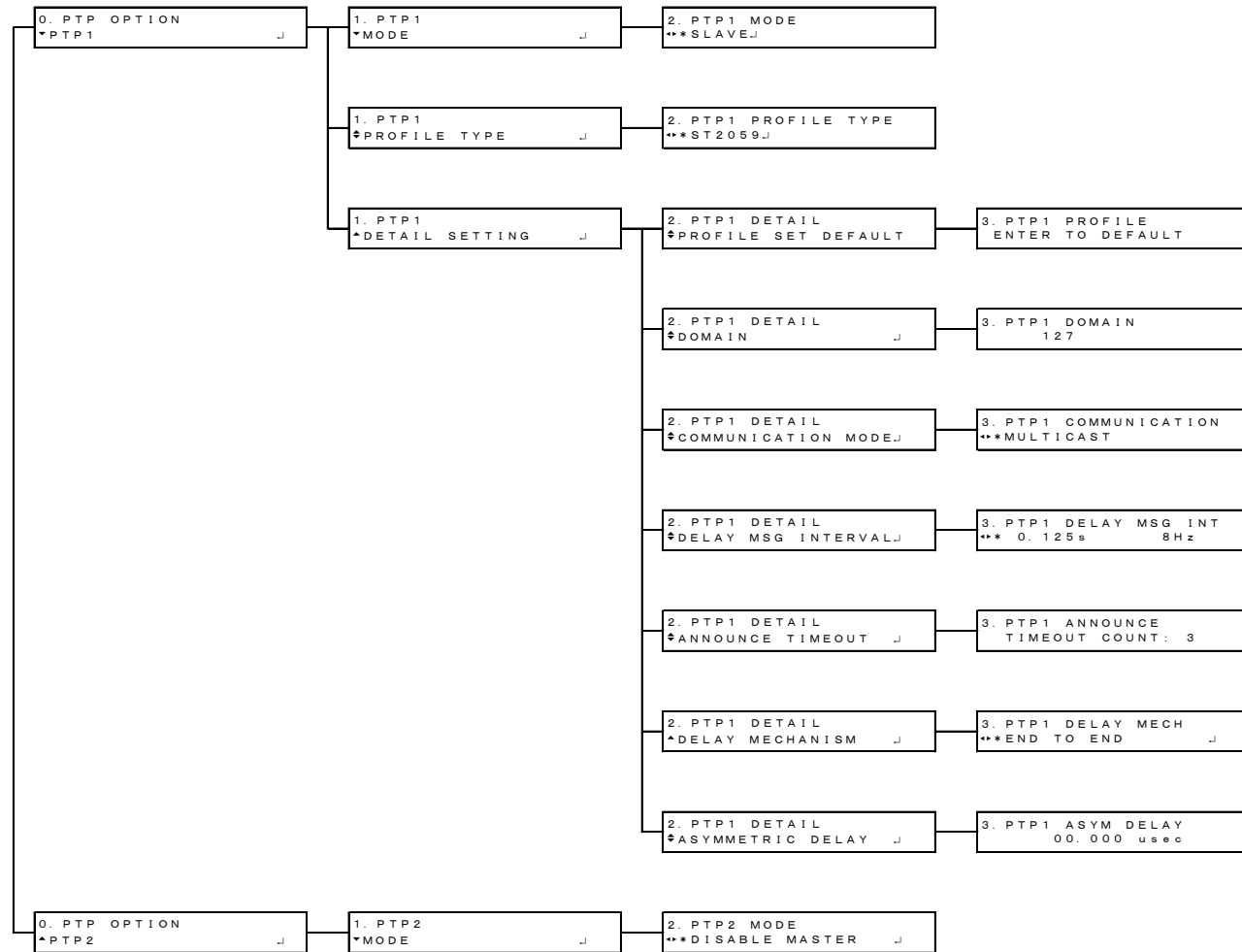

25.2.13 SYSTEM menu

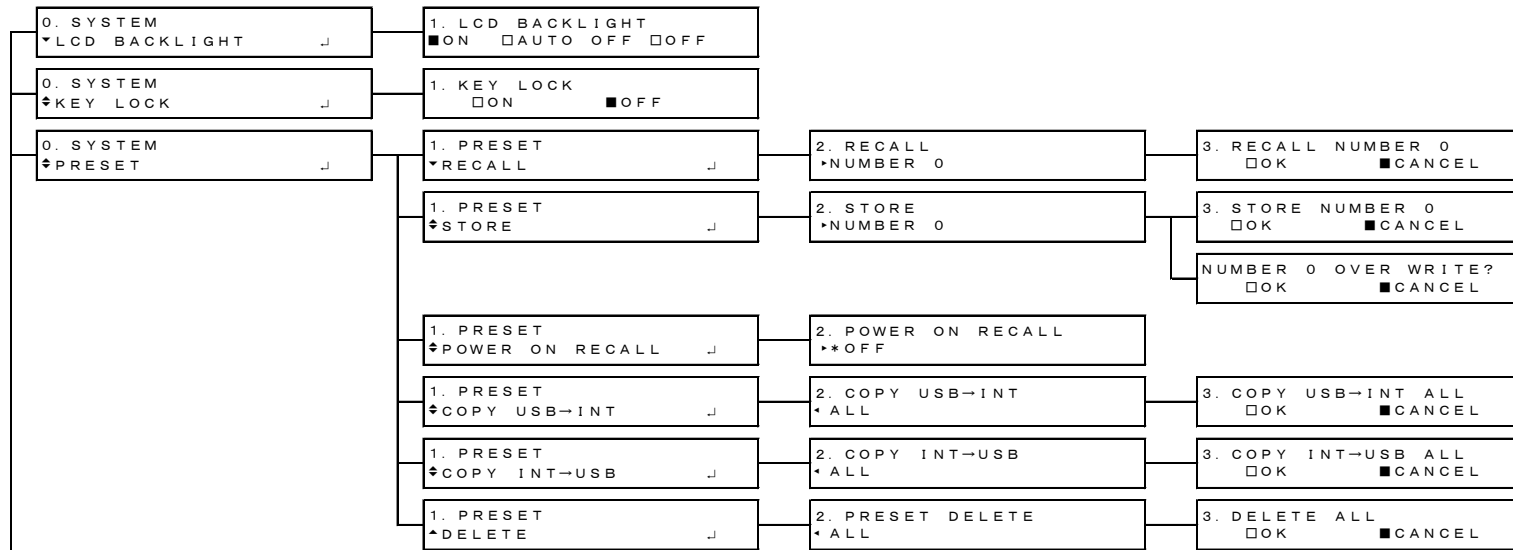

## 25. APPENDIX

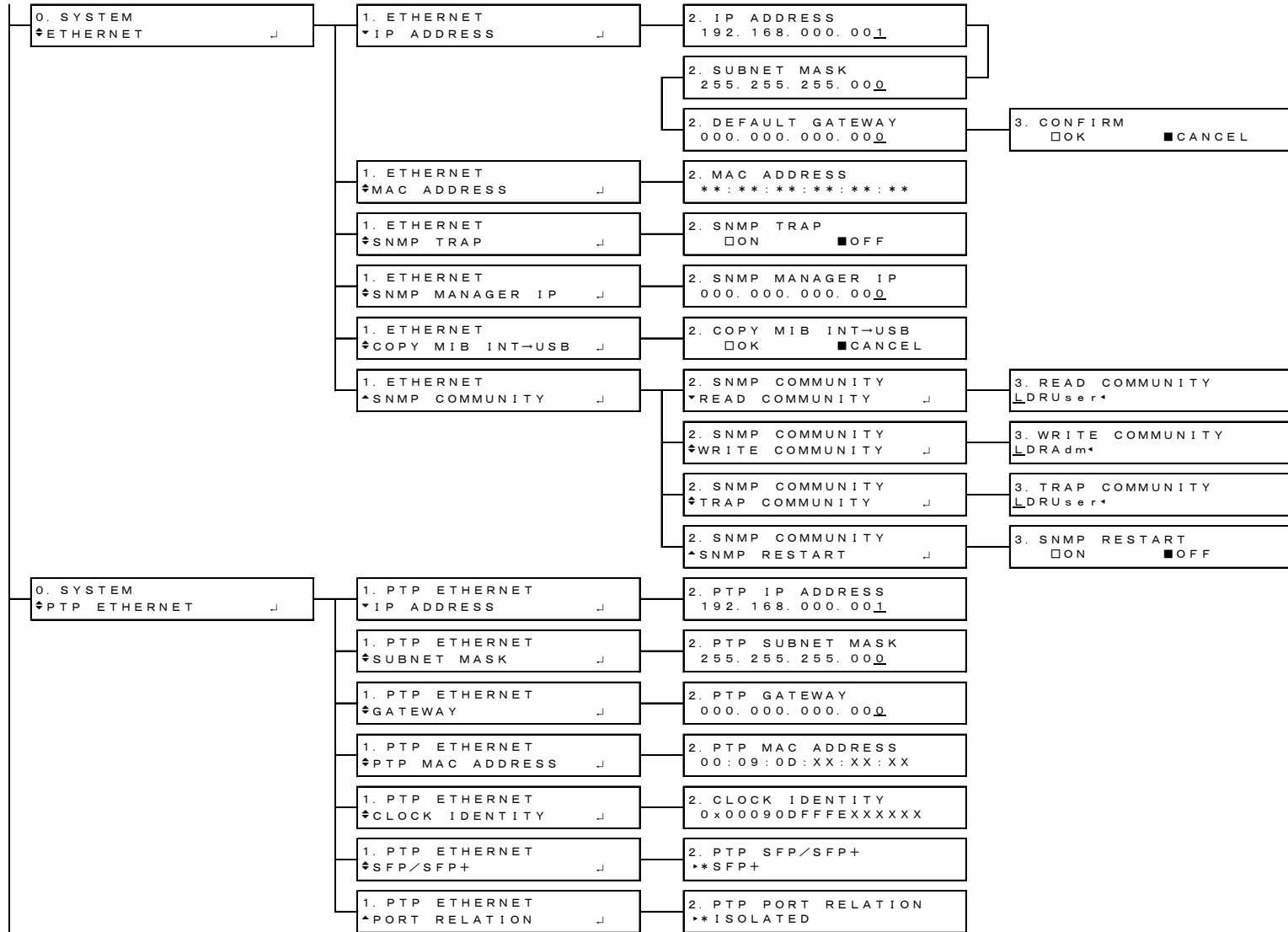



## 25. APPENDIX

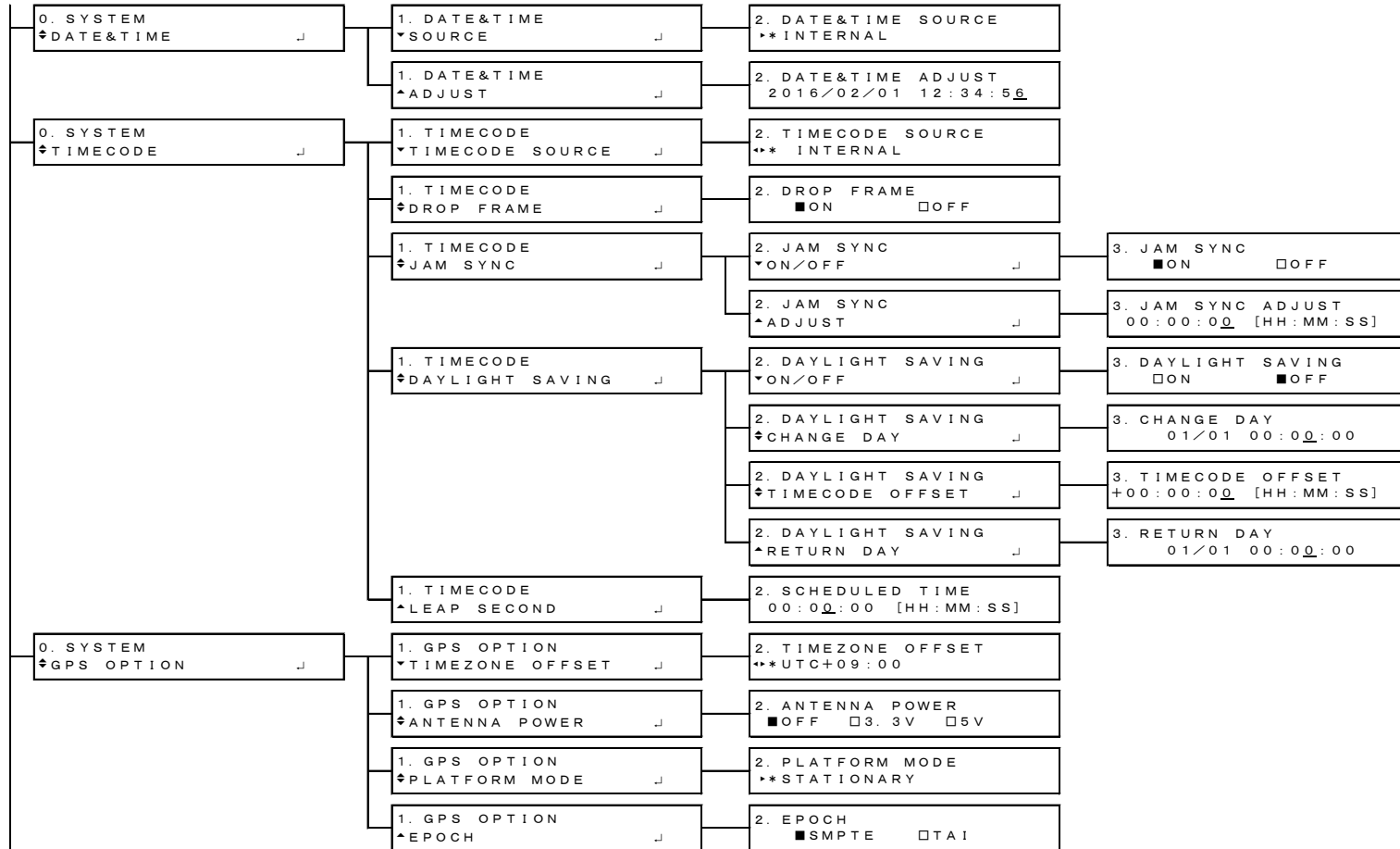

25. APPENDIX

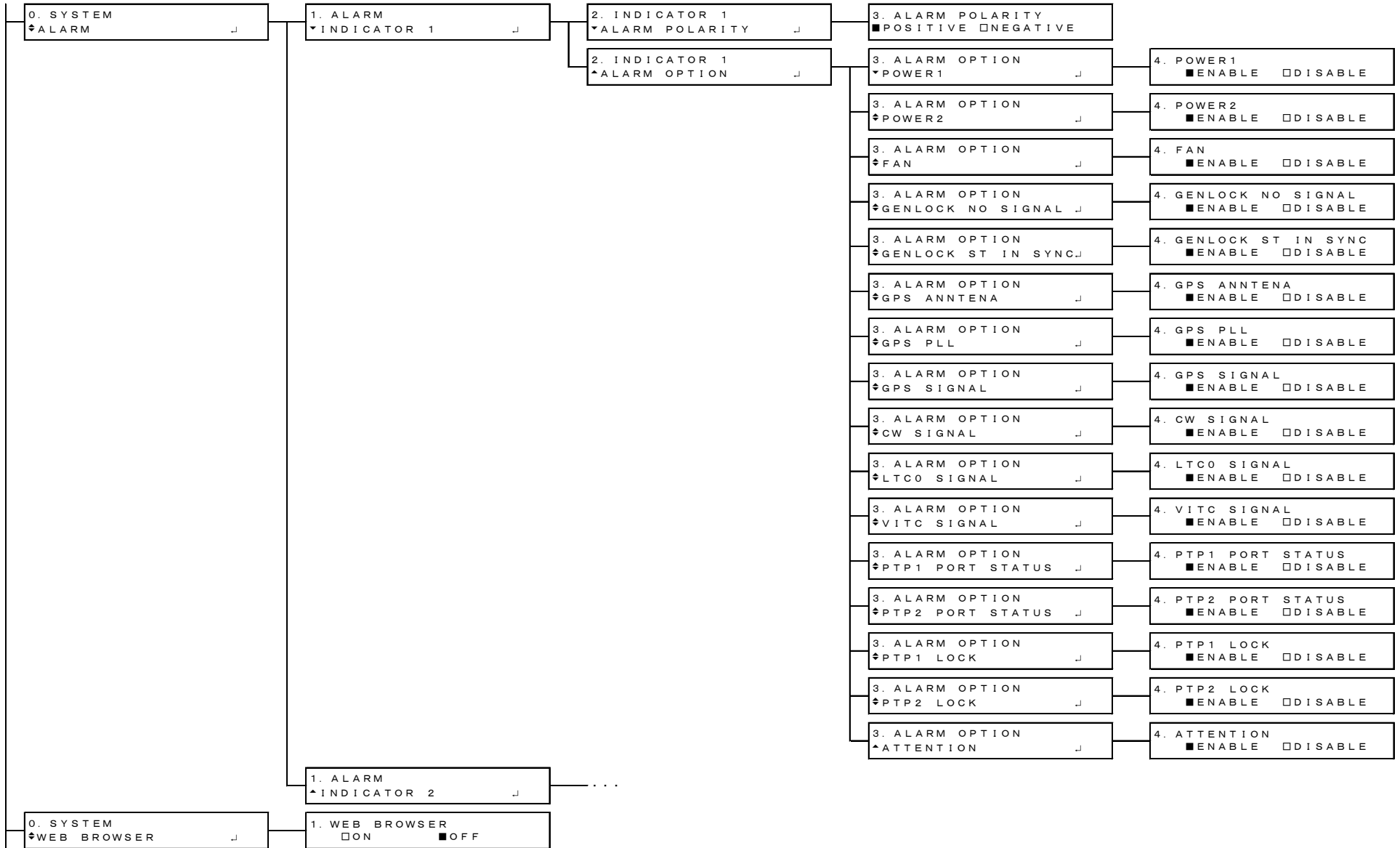

25. APPENDIX

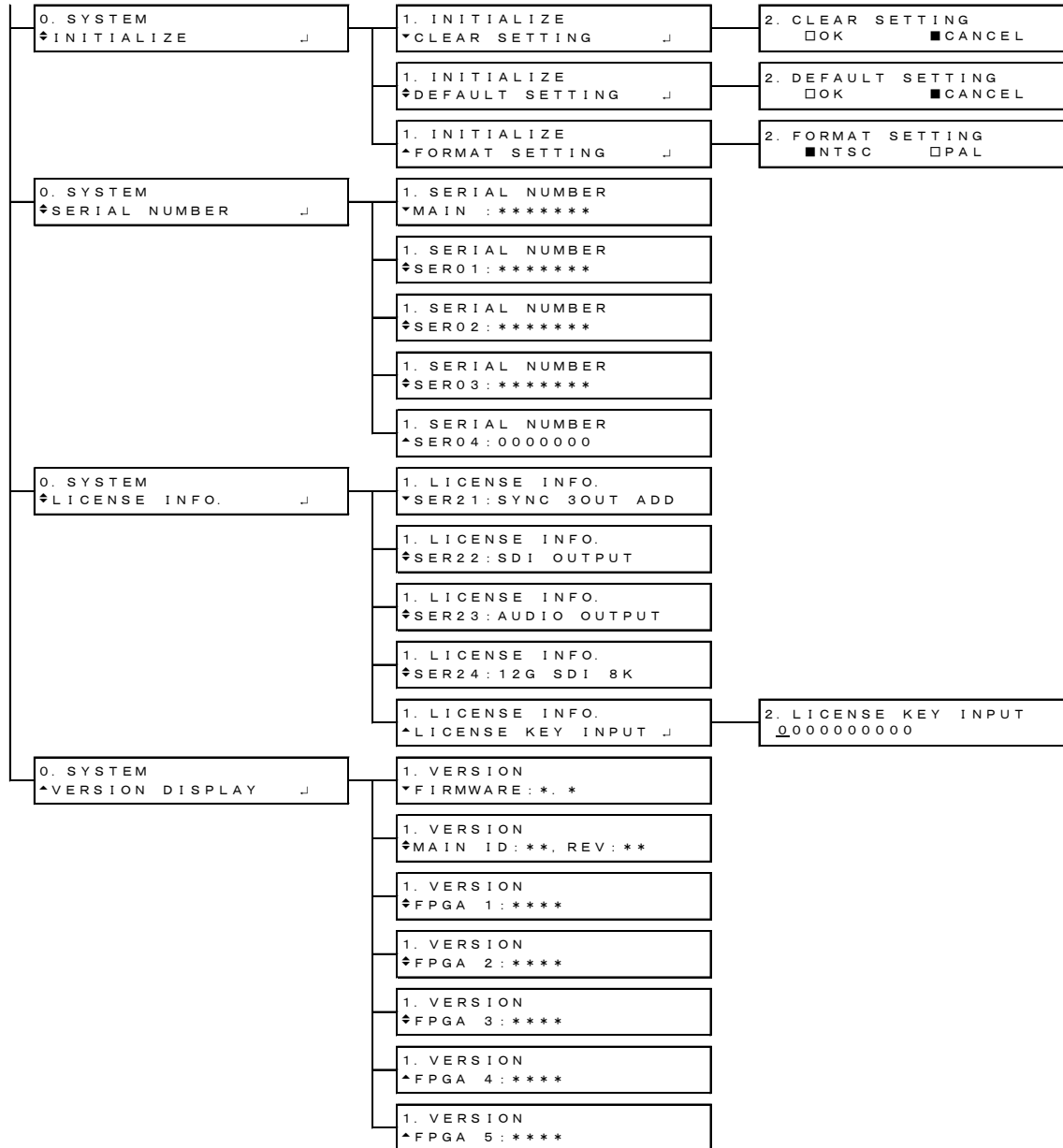

### 25.3 Firmware Update History

This manual is written for the following firmware versions.

LT 4610 : Ver. 5.5

LT 4611 : Ver. 3.0

To view the firmware version, select SYSTEM→VERSION DISPLAY→FIRMWARE.

- Ver. 5.5 on the LT 4610, Ver. 3.0 on the LT 4611  
[SER04] LT 4610SER04 (GPS/BDS) is now supported.
- Ver. 5.4 on the LT 4610, Ver. 2.9 on the LT 4611  
[SER03] Improved so that MASTER ID can be displayed in PTP Slave mode.
- Ver. 5.3 on the LT 4610, Ver. 2.8 on the LT 4611  
Minor changes
- Ver. 5.2 on the LT 4610, Ver. 2.7 on the LT 4611  
Minor changes
- Ver. 5.1  
Minor changes
- Ver. 5.0  
Minor changes
- Ver. 4.9  
Minor changes
- Ver. 4.8  
[LT 4610] Fixed that the description of the MIB file may not work depending on the SNMP manager.
- Ver. 4.7  
Minor changes
- Ver. 4.6 on the LT 4610, Ver. 2.1 on the LT 4611  
[LT 4610/LT 4611] A function to record power failure, fan stop, and a function to record such as interruption of analog video sync signal when the genlock format is analog video sync signal were added to the genlock log item.  
[LT 4610/LT 4611] Alarm and attention were added to the status item of the web browser.  
[SER02] Improved the "POWER ON RECALL" display of the user pattern to "POWER ON LOAD".  
[SER02] S-LOG3 Live HDR Multifformat Color Bar in the archive was changed to Ver1.11.
- Ver. 4.5  
Minor changes

- Ver. 4.4
  - [SER03] BMCA Enable/Disable function was added.
  - [SER03] When the genlock mode is analog video sync signal, the function to select PTP as the time code source was added.
- Ver. 4.3
  - Minor changes
- Ver. 4.2
  - Minor changes
- Ver. 4.1
  - Minor changes
- Ver. 4.0
  - Minor changes
- Ver. 3.9 on the LT 4610, Ver. 1.5 on the LT 4611
  - [SER02] HDR/SDR selection and USER PAYLOAD function were added to the 12G OPTION menu.
  - [SER24] LT 4610SER24 (8K) is now supported.
- Ver. 3.8
  - Minor changes
- Ver. 3.7
  - [SER02] For 12G, it was changed to able to set a natural picture to a pattern for each channel.
- Ver. 3.6
  - [SER02] For 12G, it was changed to able to select the pattern for each channel.
- Ver. 3.5
  - [SER03] The function to import PTP time code from VITC (hours, minutes and seconds only) or VITC+SMPTE ST 309 (year, month, day) was added.
  - [SER03] The function to display CLOCK IDENTITY on the panel and web browser was added.
- Ver. 3.4
  - Minor changes
- Ver. 3.3
  - Minor changes
- Ver. 3.2
  - Minor changes
- Ver. 3.1
  - Minor changes

- Ver. 3.0  
[LT 4610] The web browser software was changed to support LT 4610SER03 (PTP).
- Ver. 2.9  
[SER02] The transfer speed of a natural picture was increased.
- Ver. 2.8  
[SER03] LT 4610SER03 (PTP) is now supported.
- Ver. 2.7  
Minor changes
- Ver. 2.6  
Minor changes
- Ver. 2.5  
Minor changes
- Ver. 2.4  
Minor changes
- Ver. 2.3  
Minor changes
- Ver. 2.2  
[LT 4610] The Web browser function was added.
- Ver. 2.1  
Minor changes
- Ver. 2.0  
[LT 4610] An SNMP community name setup function was added.  
[LT 4610] Changed the menu and operation of GENLOCK RECOVERY.
  - Renamed HOLD to MANUAL
  - Added a setting (MANUAL SETTING) to return from STAY-IN-SYNC in MANUAL MODE
  - Renamed MANUAL ADJUST to GENLOCK RESET
  - Changed specifications to always output SDI and BB output in GENCLOCK recovery operation
 [SER02] LT 4610SER02 (12G-SDI) is now supported.
- Ver. 1.9  
Minor changes
- Ver. 1.8  
Minor changes
- Ver. 1.7  
Minor changes

## 25. APPENDIX

- Ver. 1.6  
Minor changes
- Ver. 1.5  
Minor changes
- Ver. 1.4  
Minor changes
- Ver. 1.3
  - [LT 4610] Output timing switching on the SDI menu was added.
  - [LT 4610] The silence signal resolution and output timing settings on the AES/EBU menu was added.
  - [LT 4610] The default audio output setting on the AES/EBU menu was changed to ON.
  - [LT 4610] The behavior of the instrument when POWER ON RECALL on the SYSTEM menu is set to OFF was changed so that Last Memory is applied.
  - [LT 4610] The serial number display and main version display on the SYSTEM menu is now supported.
  - [SER01] CW output and 1PPS output is now supported.
  - [SER01] The alarms output from LTC IN/OUT is now supported.
  - [SER01] VITC is now supported.
- Ver. 1.2  
Minor changes
- Ver. 1.1
  - [LT 4610] Changed the initial setting of AES / EBU to ON.
- Ver. 1.0  
New release

Following information is for Chinese RoHS only

## 所含有毒有害物质信息

部件号码: LT 4610



此标志适用于在中国销售的电子信息产品,依据2006年2月28日公布的《电子信息产品污染控制管理办法》以及SJ/T11364-2006《电子信息产品污染控制标识要求》,表示该产品在使用完结后可再利用。数字表示的是环境保护使用期限,只要遵守与本产品有关的安全和使用上的注意事项,从制造日算起在数字所表示的年限内,产品不会产生环境污染和对人体、财产的影响。产品适当使用后报废的方法请遵从电子信息产品的回收、再利用相关法令。详细请咨询各级政府主管部门。

产品中有毒有害物质或元素的名称及含量

部件名称 Parts	有毒有害物质或元素 Hazardous Substances in each Part					
	铅 (Pb)	汞 (Hg)	镉 (Cd)	六价铬 (Cr(VI))	多溴联苯 (PBB)	多溴二苯醚 (PBDE)
实装基板	×	○	○	○	○	○
主体部	×	○	○	○	○	○
液晶显示模组	○	○	○	○	○	○
开关电源	×	○	○	○	○	○
风扇	×	○	○	○	○	○
外筐	×	○	○	○	○	○
线材料一套	×	○	○	○	○	○
附件	×	○	○	○	○	○
包装材	○	○	○	○	○	○
电池	○	○	○	○	○	○
选件						
4610SER01	×	○	○	○	○	○
4610SER02	×	○	○	○	○	○
4610SER03	×	○	○	○	○	○
4610SER04	×	○	○	○	○	○
备注)						
○: 表示该有毒有害物质在该部件所有均质材料中的含量均在SJ/T11363-2006 规定的限量要求以下。						
×: 表示该有毒有害物质或元素至少在该部件的某一均质材料中的含量超出SJ/T11363-2006 标准规定的限量要求。						

Ver. 2



Following information is for Chinese RoHS only

## 所含有毒有害物质信息

部件号码: LT 4611



此标志适用于在中国销售的电子信息产品,依据2006年2月28日公布的

《电子信息产品污染控制管理办法》以及SJ/T11364-2006《电子信息产品污染控制标识要求》,表示该产品在使用完结后可再利用。数字表示的是环境保护使用期限,只要遵守与本产品有关的安全和使用上的注意事项,从制造日算起在数字所表示的年限内,产品不会产生环境污染和对人体、财产的影响。

产品适当使用后报废的方法请遵从电子信息产品的回收、再利用相关法令。

详细请咨询各级政府主管部门。

产品中有毒有害物质或元素的名称及含量

部件名称 Parts	有毒有害物质或元素 Hazardous Substances in each Part					
	铅 (Pb)	汞 (Hg)	镉 (Cd)	六价铬 (Cr(VI))	多溴联苯 (PBB)	多溴二苯醚 (PBDE)
实装基板	×	○	○	○	○	○
主体部	×	○	○	○	○	○
液晶显示模组	○	○	○	○	○	○
开关电源	×	○	○	○	○	○
风扇	×	○	○	○	○	○
外筐	×	○	○	○	○	○
线材料一套	×	○	○	○	○	○
附件	×	○	○	○	○	○
包装材	○	○	○	○	○	○
电池	○	○	○	○	○	○
选件						
4610SER01	×	○	○	○	○	○
4610SER02	×	○	○	○	○	○
4610SER03	×	○	○	○	○	○
4610SER04	×	○	○	○	○	○
备注)						
○: 表示该有毒有害物质在该部件所有均质材料中的含量均在SJ/T11363-2006 规定的限量要求以下。						
×: 表示该有毒有害物质或元素至少在该部件的某一均质材料中的含量超出SJ/T11363-2006 标准规定的限量要求。						

Ver. 3

## **Leader Electronics Corporation**

2-6-33 Tsunashimahigashi , Kohoku-ku , Yokohama-shi ,  
Kanagawa , 223-8505 , Japan

[www.leader.co.jp](http://www.leader.co.jp)

Jul. 9, 2021 Ver.7 (LT 4610 Firmware Ver. 5.5 LT 4611 Firmware Ver. 3.0)